

# **USER'S MANUAL**

**SP-7117**

**Intel® D2550 CPU  
17" Fanless & Low Power Panel PC  
With DVI/2LAN/3COM**

**SP-7117 M1**

---

---

***SP-7117 Intel<sup>®</sup> D2550***  
***17” Fanless & Low Power Panel PC***  
***With DVI/2LAN/3COM***

**COPYRIGHT NOTICE & TRADEMARK**

All trademarks and registered trademarks mentioned herein are the property of their respective owners.

This manual is copyrighted in Dec. 2013. You may not reproduce or transmit in any form or by any means, electronic, or mechanical, including photocopying and recording.

**DISCLAIMER**

This user’s manual is meant to assist you in installing and setting up the system. The information contained in this document is subject to change without any notice.

**CE NOTICE**

This is a class A product. In a domestic environment this product may cause radio interference in which case the user may be required to take adequate measures.

---

---

---

---

## FCC NOTICE

This equipment has been tested and found to comply with the limits for a Class A digital device, pursuant to part 15 of the FCC Rules. These limits are designed to provide reasonable protection against harmful interference when the equipment is operated in a commercial environment. This equipment generates, uses, and can radiate radio frequency energy and, if not installed and used in accordance with the instruction manual, may cause harmful interference to radio communications. Operation of this equipment in a residential area is likely to cause harmful interference in which case the user will be required to correct the interference at his own expense.

You are cautioned that any change or modifications to the equipment not expressly approve by the party responsible for compliance could void your authority to operate such equipment.

**CAUTION!** Danger of explosion if battery is incorrectly replaced. Replace only with the same or equivalent type recommended by the manufacturer. Dispose of used batteries according to the manufacturer's instructions.

**WARNING!** Some internal parts of the system may have high electrical voltage. And therefore we strongly recommend that qualified engineers can open and disassemble the system. The LCD and touch screen are easily breakable, please handle them with extra care.

---

---

## TABLE OF CONTENTS

### CHAPTER 1 INTRODUCTION

1-1	About This Manual.....	1-2
1-2	System Illustration.....	1-3
1-3	System Specifications.....	1-5
1-4	Safety Precautions.....	1-7

### CHAPTER 2 SYSTEM CONFIGURATION

2-1	System External I/O Port & Pin Assignment.....	2-2
2-2	Mainboard Component Locations & Jumper Settings.....	2-6

### CHAPTER 3 SOFTWARE UTILITIES

3-1	Introduction.....	3-2
3-2	Intel® Chipset Software Installation Utility.....	3-3
3-3	VGA Driver Utility.....	3-4
3-4	LAN Driver Utility.....	3-5
3-5	Sound Driver Utility.....	3-6
3-6	Touchscreen Driver Utility.....	3-7

### CHAPTER 4 AMI BIOS SETUP

4-1	Introduction.....	4-2
4-2	Entering Setup.....	4-4
4-3	Main.....	4-7
4-4	Advanced.....	4-9
4-5	Chipset.....	4-35
4-6	Boot.....	4-41
4-7	Security.....	4-44
4-8	Save & Exit.....	4-45

### APPENDIX A SYSTEM DIAGRAMS

	Exploded Diagram for System with Capacitive Panel.....	A-2
	Exploded Diagram for System with Resistive Panel.....	A-10

---

---

Exploded Diagram for HDD..... A-18

**APPENDIX B TECHNICAL SUMMARY**

Block Diagram..... B-2  
Interrupt Map..... B-3  
DMA Channels Map..... B-4  
I/O Map..... B-5  
Watchdog Timer Configuration..... B-8  
Flash BIOS Update..... B-10

# ***INTRODUCTION***

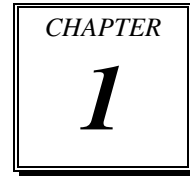

This chapter gives you the information for SP-7117. It also outlines the System specification.

Section includes:

- About This Manual
- System Specifications
- Safety Precautions

**Experienced users can skip to chapter 2 on page 2-1 for Quick Start.**

## **1-1. ABOUT THIS MANUAL**

Thank you for purchasing our SP-7117 Intel® D2550 17” fanless & low power panel PC with DVI/2LAN/3COM. SP-7117 provides faster processing speed, greater expandability and can handle more task than before. This manual is designed to assist you how to install and set up the system. It contains four chapters. The user can apply this manual for configuration according to the following chapters:

### ***Chapter 1 Introduction***

This chapter introduces you to the background of this manual, and the specifications for this system. The final page of this chapter will indicate how to avoid damaging this board.

### ***Chapter 2 Hardware Configuration***

This chapter outlines the component locations and their functions. In the end of this chapter, you will learn how to set jumper and how to configure this card to meet your own needs.

### ***Chapter 3 Software Utilities***

This chapter contains helpful information for proper installations of the VGA utility, LAN utility, and Sound utility.

### ***Chapter 4 BIOS Setup***

This chapter indicates you how to set up the BIOS configurations.

### ***Appendix A System Diagrams***

This appendix gives you the exploded diagrams and part numbers of the SP-7117.

### ***Appendix B Technical Summary***

This appendix gives you the information about the Technical maps, Watchdog-timer configuration, and Flash BIOS Update.

## 1-2. SYSTEM ILLUSTRATION

Front View

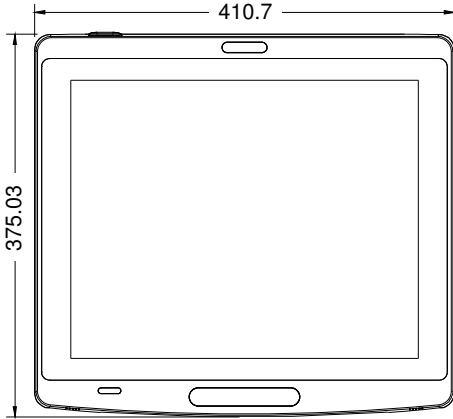

Rear View

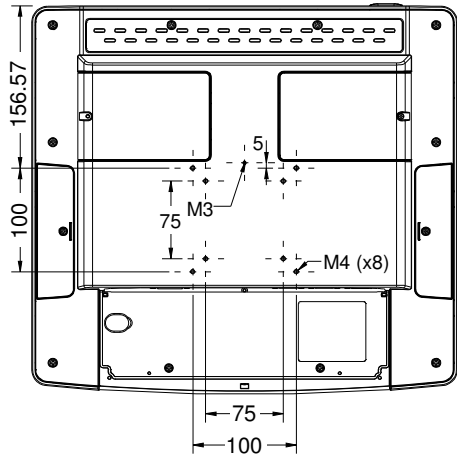

Top View

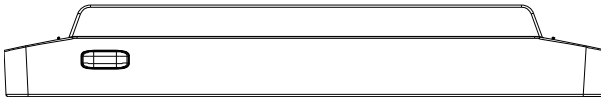

Bottom View

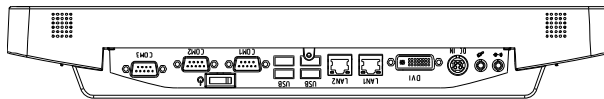

Unit: mm



**Side View**

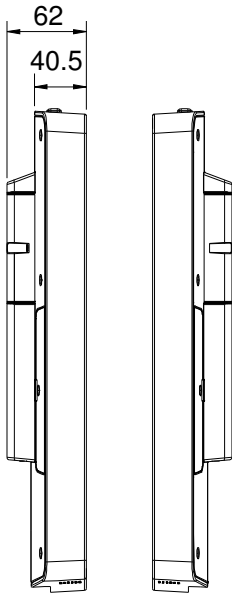

**Quarter View**

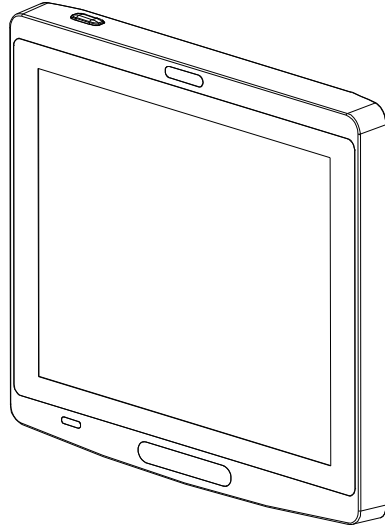

Unit: mm

## 1-3. SYSTEM SPECIFICATION

### System

CPU Support	Intel® D2550 (1.86GHz, 1M cache)
Chipset	Intel® NM10
OS Support	Microsoft Windows 7
Memory Support	1 x DDR3 SO-DIMM socket (1067 MHz, up to 4GB)
Watchdog	1~255s Watchdog timer
Drive Bay	1x 2.5" SATA HDD
Power Supply	DC-in 9~36V
Mounting Type	VESA 75/100
IP65	Front panel only
System Weight	5.95 kg
Dimension (W x H x D)	410.7 x 374.6 x 62 mm (16.16" x 14.75" x 2.44")
Certificate	CE/FCC

### I/O Ports

Serial Port	3 ports, RI/5V/12V selectable: <ul style="list-style-type: none"> <li>▪ COM1 for RS-232</li> <li>▪ COM2/3 for RS-232/422/485</li> </ul>
USB	4 x USB 2.0
LAN	2 x LAN (RJ-45, 10/100/1000 Mbps)
DVI	1 x DVI-I
Audio	High Definition: <ul style="list-style-type: none"> <li>▪ 1 x Line-out</li> <li>▪ 1 x MIC-in</li> </ul>
Expansion slot	<ul style="list-style-type: none"> <li>▪ 1 x Mini-PCIe slot</li> <li>▪ 1 x CFAST card slot</li> </ul>

### Display

LCD Panel	17" TFT LCD (LED)
Resolution (Brighness)	1280 x 1024

Touchscreen	5-wire bezel-free resistive or projected-capacitive
-------------	---

**Environment**

Operation Temp.	<ul style="list-style-type: none"><li>▪ HDD: 0 ~ 45°C (32 ~ 113°F)</li><li>▪ CFast card: 0 ~ 55°C (32 ~ 131°F)</li></ul>
Storage Temp.	-20 ~ 60°C (-4 ~ 140°F)
Humidity	Operating: 20 ~ 90% Storage: 20~95%

## **1-4. SAFETY PRECAUTIONS**

Follow the messages below to avoid your systems from damage:

1. Keep your system away from static electricity on all occasions.
2. Prevent electric shock. Don't touch any components of this card when the card is power-on. Always disconnect power when the system is not in use.
3. Disconnect power when you change any hardware devices. For instance, when you connect a jumper or install any cards, a surge of power may damage the electronic components or the whole system.

# ***HARDWARE CONFIGURATION***

CHAPTER

**2**

## **\*\* *QUICK START* \*\***

Helpful information describes the jumper & connector settings, and component locations.

Section includes:

- Jumper & Connector Quick Reference Table
- Component Locations
- Configuration and Jumper settings
- Connector's Pin Assignments

## 2-1. SYSTEM EXTERNAL I/O PORT & PIN ASSIGNMENT

### I/O View

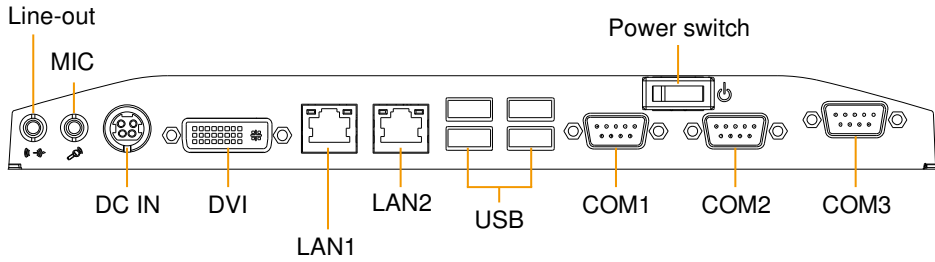

### 2-1-1. DC IN Port

**DC IN:** DC Power-In Port

PIN	ASSIGNMENT	PIN	ASSIGNMENT
1	GND	3	VCC24_SB_VIN
2	GND	4	VCC24_SB_VIN

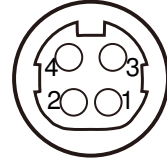

**DC IN**

### 2-1-2. Audio Jack

**Line-Out:** Audio Line-Out Jack

Connected from Audio1 connector.

Refer to Audio1 pin assignment in section *Mainboard Components Locations & Jumper Settings*.

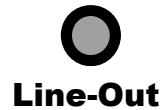

**Line-Out**

### 2-1-3. COM Ports

**COM1, COM2, COM3:** COM Ports

PIN	ASSIGNMENT	PIN	ASSIGNMENT
1	DCD_C	6	DSR_C
2	RX_C	7	RTS_C
3	TX_C	8	CTS_C
4	DTR_C	9	RI_SEL
5	GND		

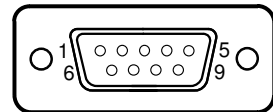

**COM1/  
COM2/  
COM3**

**Note:** COM3 port is connected from a connector on board. Refer to the section *COM connector*.

2-1-4. DVI Port

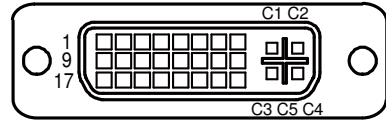

**DVI1**

**DVI:** DVI-I Port

PIN	ASSIGNMENT	PIN	ASSIGNMENT
1	TMDS_2-	16	HPD
2	TMDS_2+	17	TMDS_0-
3	GND	18	TMDS0+
4	NC	19	GND
5	NC	20	NC
6	DDC_CLK	21	NC
7	DDC_DATA	22	GND
8	VSYNC	23	TMDS_CLK+
9	TMDS_1-	24	TMDS_CLK-
10	TMDS_1+	C1	RED
11	GND	C2	GREEN
12	NC	C3	BLUE
13	NC	C4	HSYNC
14	5V	C5	GND
15	GND	C6	GND



### 2-1-5. LAN Port

LAN1, LAN2: RJ45 LAN Ports

PIN	ASSIGNMENT	PIN	ASSIGNMENT
1	MDI0_DP	5	MDI2_DP
2	MDI0_DN	6	MDI2_DN
3	MDI1_DP	7	MDI3_DP
4	MDI1_DN	8	MDI3_DN

Green Yellow

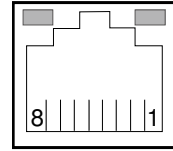

**LAN1/  
LAN2**

#### LAN LED Indicator:

Left Side LED

Green Color On	10/100 LAN Speed Indicator
Orange Color On	Giga LAN Speed Indicator
Off	No LAN switch/hub connected.

Right Side LED

Yellow Color Blinking	LAN Message Active
Off	No LAN Message Active

### 2-1-6. USB Ports

USB Ports: Two USB Double Stack Connectors

PIN	ASSIGNMENT	PIN	ASSIGNMENT
1	+5V	5	+5V
2	DN	6	DN
3	DP	7	DP
4	GND	8	GND

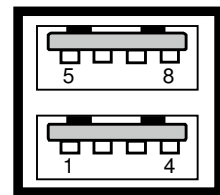

**USB**

## 2-2. MAINBOARD COMPONENT LOCATIONS & JUMPER SETTINGS

M/B: SB-6310

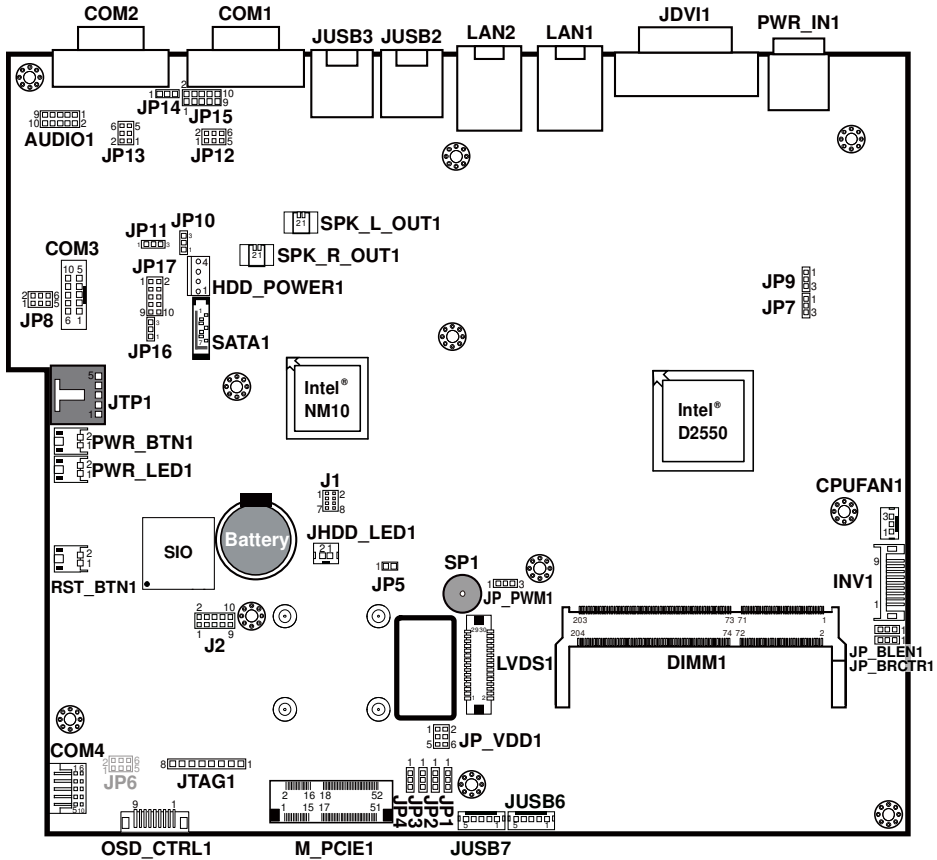

SP-7117 Connectors, Jumpers and Component Locations

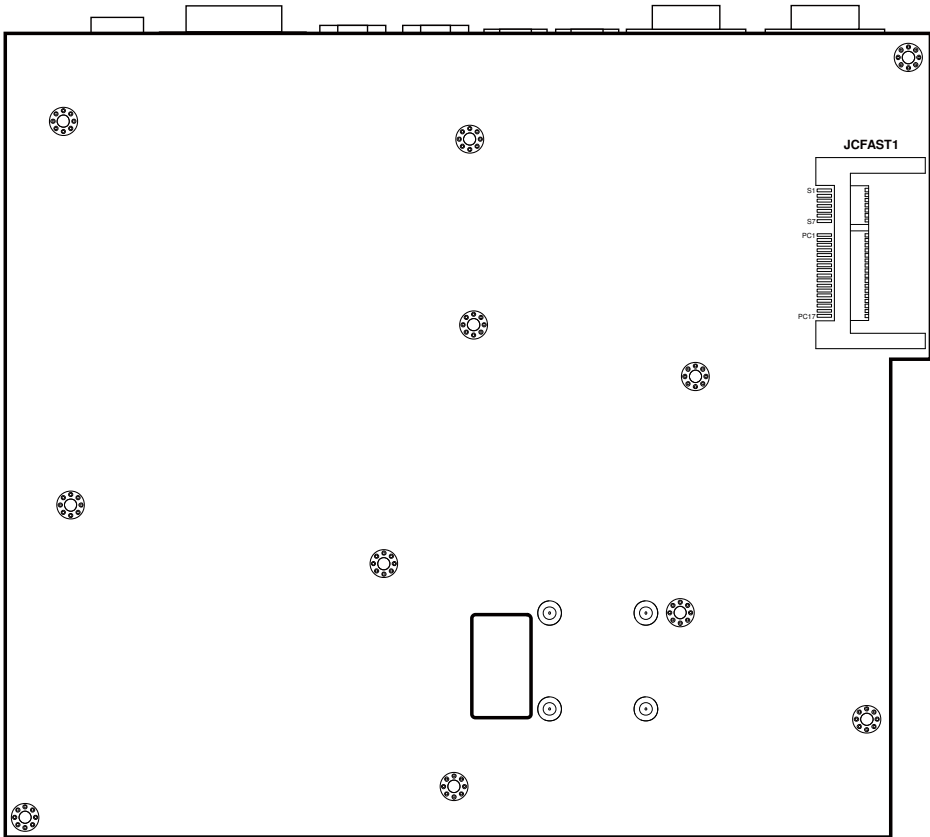

SP-7117 Component Location

### 2-2-1. Jumpers & Connectors Quick Reference Table

<b>JUMPER/CONNECTOR</b>	<b>NAME</b>
COM Ports RI & Voltage Selection	JP12, JP13, JP8, JP6
COM2 & COM3 RS-232/422/485	JP15, JP17
COM2 & COM3 RS-485 DIR Control Selection	JP14, JP16
COM Connector	COM3, COM4
USB Connector	JUSB6, JUSB7
CFAST Voltage Selection	JP11
Low Pin Count Connector	J2
SPI Connector	J1
SATA Connector	SATA1
Mini-PCIe Connector	M_PCIE1
Clear CMOS Data Selection	JP5
CPLD Connector	JTAG1
LCD Panel Resolution Selection	JP1, JP2, JP3, JP4
LCD Panel Brightness Control Selection	JP_BRCTR1
LCD Panel Backlight Selection	JP_BLEN1, JP_PWM1
Touch Panel Connector	JTP1
LED Backlight Connector	INV1
OSD Function Connector	OSD_CTRL1
LVDS Connector	LVDS1
LVDS Voltage Selection	JP_VDD1
Pull-In Mode Selection	JP7
Run Pin Selection	JP9
Power Mode Selection	JP10
Power LED Connector	PWR_LED1
Power Button Connector	PWR_BTN1
Reset Button Connector	RST_BTN1
HDD Power Connector	HDD_POWER1
HDD LED Connector	JHDD_LED1
Fan Connector	CPUFAN1
Audio Connector	Audio1, SPK_L_OUT1, SPK_R_OUT1

## 2-2-2. How to Set Jumpers

You can configure your board by setting jumpers. Jumper is consists of two or three metal pins with a plastic base mounted on the card, and by using a small plastic "cap", Also known as the jumper cap (with a metal contact inside), you are able to connect the pins. So you can set-up your hardware configuration by "open" or "close" pins.

The jumper can be combined into sets that called jumper blocks. When the jumpers are all in the block, you have to put them together to set up the hardware configuration. The figure below shows how this looks like.

### Jumpers & Caps

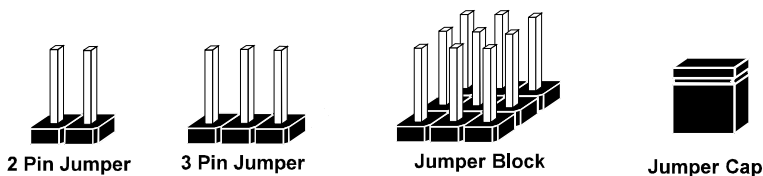

If a jumper has three pins (for examples, labelled PIN1, PIN2, and PIN3), You can connect PIN1 & PIN2 to create one setting by shorting. You can either connect PIN2 & PIN3 to create another setting. The same jumper diagrams are applied all through this manual. The figure below shows what the manual diagrams look and what they represent.

### Jumper Diagrams



Jumper Cap  
looks like this

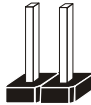

2 pin Jumper  
looks like this

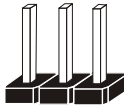

3 pin Jumper  
looks like this



Jumper Block  
looks like this

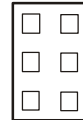

### Jumper Settings



2 pin Jumper close(enabled)  
Looks like this



3 pin Jumper  
2-3 pin close(enabled)  
Looks like this



Jumper Block  
1-2 pin close(enabled)  
Looks like this

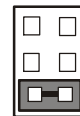

### 2-2-3. COM Ports RI & Voltage Selection

**JP12, JP13, JP8, JP6 (Reserved):** COM1, 2, 3, 4 Ports RI & Voltage Selection

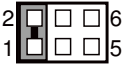
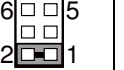
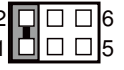
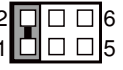
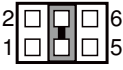
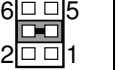
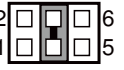
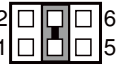
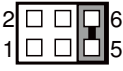
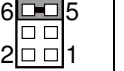
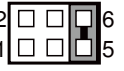
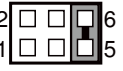
SELECTION	JUMPER SETTING	JUMPER ILLUSTRATION			
		COM1	COM2	COM3	COM4 (Reserved)
RI	1-2	 <p style="text-align: center;"><b>JP12</b></p>	 <p style="text-align: center;"><b>JP13</b></p>	 <p style="text-align: center;"><b>JP8</b></p>	 <p style="text-align: center;"><b>JP6</b></p>
12V	3-4	 <p style="text-align: center;"><b>JP12</b></p>	 <p style="text-align: center;"><b>JP13</b></p>	 <p style="text-align: center;"><b>JP8</b></p>	 <p style="text-align: center;"><b>JP6</b></p>
5V	5-6	 <p style="text-align: center;"><b>JP12</b></p>	 <p style="text-align: center;"><b>JP13</b></p>	 <p style="text-align: center;"><b>JP8</b></p>	 <p style="text-align: center;"><b>JP6</b></p>

**Note:** Manufacturing Default is RI.

**2-2-4. COM2 & COM3 RS-232/422/485 Selection**

**JP15, JP17:** COM2, COM3 RS-232/422/485 Selection

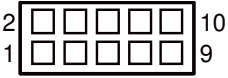
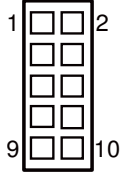
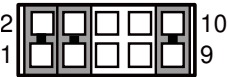
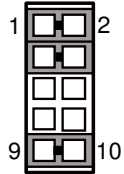
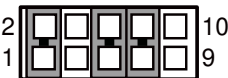
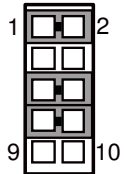

SELECTION	JUMPER SETTING	JUMPER ILLUSTRATION	
		COM2	COM3
RS-232	All open	 <p><b>JP15</b></p>	 <p><b>JP17</b></p>
RS-422	1-2, 3-4, 9-10	 <p><b>JP15</b></p>	 <p><b>JP17</b></p>
RS-485	1-2, 5-6, 7-8	 <p><b>JP15</b></p>	 <p><b>JP17</b></p>

**Note:** Manufacturing Default is RS-232.



### 2-2-5. COM 2 & COM3 RS-485 DIR Control Selection

**JP14, JP16:** COM2, COM3 RS-485 DIR Control Selection

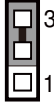
SELECTION	JUMPER SETTING	JUMPER ILLUSTRATION	
		COM2	COM3
Manual	1-2	 <p><b>JP14</b></p>	 <p><b>JP16</b></p>
Auto RS-485	2-3	 <p><b>JP14</b></p>	 <p><b>JP16</b></p>

**Note:** Manufacturing Default is Auto RS-485.

### 2-2-6. COM Connector

**COM3:** COM Connector

PIN	ASSIGNMENT	PIN	ASSIGNMENT
1	DCD_C	6	DSR_C
2	RX_C	7	RTS_C
3	TX_C	8	CTS_C
4	DTR_C	9	RI_SEL
5	GND		

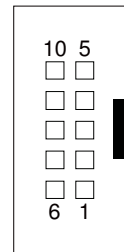

**COM3**

**COM4:** COM Connector

PIN	ASSIGNMENT	PIN	ASSIGNMENT
1	DCD_C	6	DSR_C
2	RX_C	7	RTS_C
3	TX_C	8	CTS_C
4	DTR_C	9	RI_SEL
5	GND		

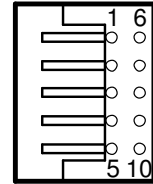

**COM4**

**2-2-7. USB Connector**

**JUSB6, JUSB7:** USB Connectors

PIN	ASSIGNMENT	PIN	ASSIGNMENT
1	+5V	4	GND
2	DN	5	GND
3	DP		

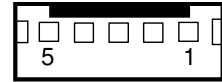

**JUSB6/  
JUSB7**

**2-2-8. CFAST Voltage Selection**

**JP11 :** CFAST Voltage Selection

SELECTION	JUMPER SETTINGS	JUMPER ILLUSTRATION
3.3V	1-2	<p><b>JP11</b></p>
5V	2-3	<p><b>JP11</b></p>

**Note:** Manufacturing Default is 3.3V.

### 2-2-9. Low Pin Count Connector

**J2:** Low Pin Count Connector

PIN	ASSIGNMENT	PIN	ASSIGNMENT
1	CLK_LPCPT	6	LPC_AD0
2	GND	7	LPC_AD3
3	LPC_FRAMEJ	8	LPC_AD2
4	GND	9	VCC3_3
5	PLTRSTJ_BUF	10	LPC_AD1

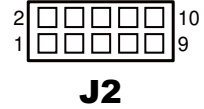

### 2-2-10. SPI Connector

**J1:** SPI Connector

PIN	ASSIGNMENT	PIN	ASSIGNMENT
1	+3.3V	5	MISO_R
2	GND	6	MOSI_R
3	CSJ_R	7	NC
4	CLK_R	8	NC

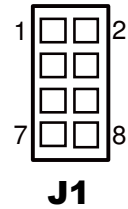

### 2-2-11. SATA Connector

**SATA1:** SATA Connector

PIN	ASSIGNMENT	PIN	ASSIGNMENT
1	GND	5	RX_DN
2	TX_DP	6	RX_DP
3	TX_DN	7	GND
4	GND		

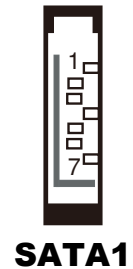

## 2-2-12. Mini-PCle Connector

**M\_PCIE1:** Mini-PCle Connector

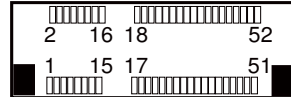

PIN	ASSIGNMENT	PIN	ASSIGNMENT
1	WAKEJ	27	GND
2	VCC3_3_SB	28	VCC1_5
3	NC	29	GND
4	GND	30	SMB_CLK
5	NC	31	PCIE_TXN4
6	VCC1_5	32	SMB_DATA
7	M_PCIE_CLKREQJ	33	PCIE_TXP4
8	SIM_PWR	34	GND
9	GND	35	GND
10	SIM_DATA	36	USB5_DN
11	MINI_PCIE_CLK_DN	37	GND
12	SIM_CLK	38	USB5_DP
13	MINI_PCIE_CLK_DP	39	VCC3_3_SB
14	SIM_RESET	40	GND
15	GND	41	VCC3_3_SB
16	SIM_VPP	42	NC
17	SIM_SW2	43	GND
18	GND	44	LED_WLANJ
19	SIM_SW1	45	NC
20	NC	46	NC
21	GND	47	NC
22	PLTRSTJ_BUF	48	VCC1_5
23	PCIE_RX4_DN	49	NC
24	VCC3_3_SB	50	GND
25	PCIE_RX4_DP	51	NC
26	GND	52	VCC3_3_SB



**M\_PCIE1**

### 2-2-13. Clear CMOS Data Selection

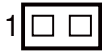
**JP5** : Clear CMOS Data Selection

SELECTION	JUMPER SETTINGS	JUMPER ILLUSTRATION
Normal	Open	 <b>JP5</b>
Clear CMOS*	Close	 <b>JP5</b>

**Note:** Manufacturing Default is Normal.

\*To clear CMOS data, user must power-off the computer and set the jumper to “Clear CMOS” as illustrated above. After five to six seconds, set the jumper back to “Normal” and power-on the computer.

### 2-2-14. CPLD Connector





**JTAG1:** CPLD Connector

PIN	ASSIGNMENT	PIN	ASSIGNMENT
1	+3.3V	5	NC
2	TDO	6	TMS
3	TDI	7	GND
4	NC	8	TCK

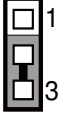

### 2-2-15. LCD Panel Resolution Selection

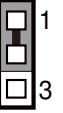
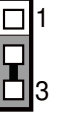
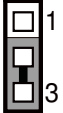

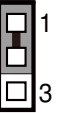
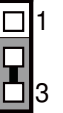
**JP1, JP2 JP3, JP4:** LCD Panel Resolution Selection

SELECTION	JUMPER SETTING	JUMPER ILLUSTRATION			
1024 x 768 1CH/24bit	JP1: 2-3 JP2: 2-3 JP3: 1-2 JP4: 2-3	 <b>JP1</b>	 <b>JP2</b>	 <b>JP3</b>	 <b>JP4</b>
1280 x 1024 2CH/24bit	JP1: 2-3 JP2: 1-2 JP3: 1-2 JP4: 2-3	 <b>JP1</b>	 <b>JP2</b>	 <b>JP3</b>	 <b>JP4</b>

**Note:** Manufacturing Default is RI.

### 2-2-16. LCD Panel Brightness Control Selection



**JP\_BRCTR1:** LCD Panel Brightness Control Selection

SELECTION	JUMPER SETTINGS	JUMPER ILLUSTRATION
LED	1-2	 <b>JP_BRCTR1</b>
CCFL	2-3	 <b>JP_BRCTR1</b>

**Note:** Manufacturing Default is LED.

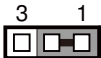

### 2-2-17. LCD Panel Backlight Selection

**JP\_BLEN1:** LCD Panel Backlight Voltage Control Selection

SELECTION	JUMPER SETTINGS	JUMPER ILLUSTRATION
3.3V	1-2	 <p style="text-align: center;"><b>JP_BLEN1</b></p>
5V	2-3	 <p style="text-align: center;"><b>JP_BLEN1</b></p>

**Note:** Manufacturing Default is 3.3V.

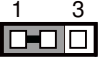
**JP\_PWM1:** Backlight Control Type Selection

SELECTION	JUMPER SETTINGS	JUMPER ILLUSTRATION
Hardware	1-2	 <p style="text-align: center;"><b>JP_PWM1</b></p>
Software	2-3	 <p style="text-align: center;"><b>JP_PWM1</b></p>

**Note:** Manufacturing Default is Software.

### 2-2-18. Touch Panel Connector

**JTP1:** Touch Panel Connector

PIN	ASSIGNMENT	PIN	ASSIGNMENT
1	LR	4	UR
2	LL	5	UL
3	PROBE		

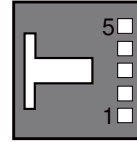

**JTP1**

### 2-2-19. LED Backlight Connector

**INV1:** LED Backlight Connector

PIN	ASSIGNMENT	PIN	ASSIGNMENT
1	+12V	6	GND
2	+12V	7	GND
3	+12V	8	BLEN
4	NC	9	BRCTR
5	GND		

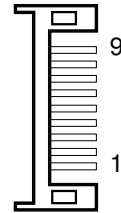

**INV1**

### 2-2-20. OSD Function Connector

**OSD\_CTRL1:** OSD Function Connector

PIN	ASSIGNMENT	PIN	ASSIGNMENT
1	BLPU	6	BKLT_PWRBTNJ
2	BLPD	7	OSD_HOME
3	GND	8	VCC5
4	VOLPU	9	VCC3_3
5	VOLPD		



**OSD\_CTRL**



### 2-2-21. LVDS Connector

**LVDS1:** LVDS Connector

PIN	ASSIGNMENT	PIN	ASSIGNMENT
1	VCC	16	CLKA_DP
2	GND	17	CLKA_DN
3	CLKB_DN	18	GND
4	CLKB_DP	19	A2_DP
5	GND	20	A2_DN
6	B2_DN	21	GND
7	B2_DP	22	A1_DP
8	GND	23	A1_DN
9	B1_DN	24	GND
10	B1_DP	25	A0_DP
11	B3_DP	26	A0_DN
12	B3_DN	27	A3_DP
13	B0_DP	28	A3_DN
14	B0_DN	29	VCC
15	GND	30	VCC

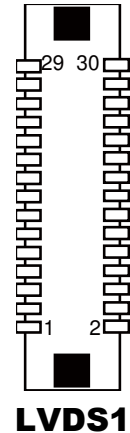

### 2-2-22. LVDS Voltage Selection

**JP\_VDD1:** Power Mode Selection

SELECTION	JUMPER SETTINGS	JUMPER ILLUSTRATION
3.3V	1-3, 2-4	<p style="text-align: center;"><b>JP_VDD1</b></p>
5V	3-5, 4-6	<p style="text-align: center;"><b>JP_VDD1</b></p>

**Note:** Manufacturing Default is 3.3V.

### 2-2-23. Pull-In Mode Selection

#### JP7: Pull-In Mode Selection

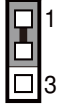
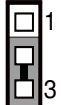
SELECTION	JUMPER SETTINGS	JUMPER ILLUSTRATION
On	1-2	 <b>JP7</b>
Off	2-3	 <b>JP7</b>

**Note:** Manufacturing Default is Off.

### 2-2-24. Run Pin Selection

#### JP9: Run Pin Selection

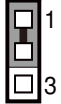
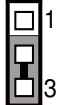
SELECTION	JUMPER SETTINGS	JUMPER ILLUSTRATION
On	1-2	 <b>JP9</b>
Off	2-3	 <b>JP9</b>

**Note:** Manufacturing Default is On.

### 2-2-25. Power Mode Selection

**JP10:** Power Mode Selection

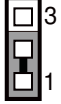
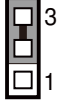
SELECTION	JUMPER SETTINGS	JUMPER ILLUSTRATION
AT	1-2	 <b>JP10</b>
ATX	2-3	 <b>JP10</b>

**Note:** Manufacturing Default is ATX.

### 2-2-26. Power LED Connector

**PWR\_LED1:** Power LED Connector

PIN	ASSIGNMENT
1	+5V
2	GND

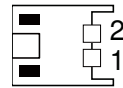

**PWR\_LED1**

### 2-2-27. Power Button Connector

**PWR\_BTN1:** Power Button Connector

PIN	ASSIGNMENT
1	PWRBTN#
2	GND

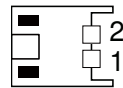

**PWR\_BTN1**

### 2-2-28. Reset Button Connector

RST\_BTN1: Speaker Connector

PIN	ASSIGNMENT
1	RST_IN
2	GND

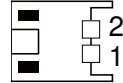

**RST\_BTN1**

### 2-2-29. HDD Power Connector

HDD\_POWER1: HDD Power Connector

PIN	ASSIGNMENT	PIN	ASSIGNMENT
1	+5V	3	GND
2	GND	4	+12V

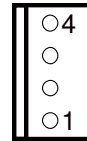

**HDD\_POWER1**

### 2-2-30. HDD LED Connector

JHDD\_LED1: Power LED Connector

PIN	ASSIGNMENT
1	+3.3V
2	GND

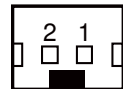

**JHDD\_LED1**

### 2-2-31. Fan Connector

CPUFAN1: Fan Connector

PIN	ASSIGNMENT
1	GND
2	OUT
3	+12V

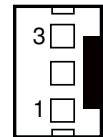

**CPUFAN1**

**2-2-32. Audio Connector**

**AUDIO1:** Audio Connector

PIN	ASSIGNMENT	PIN	ASSIGNMENT
1	MIC_IN	6	LINE-R
2	MIC_VDD	7	GND
3	GND	8	GND
4	GND	9	SPK_L
5	LINE_L	10	SPK_R

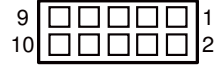

**AUDIO1**

**SPK\_L\_OUT1:** Speaker Connector

PIN	ASSIGNMENT
1	SPKL_P
2	SPKL_M

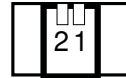

**SPK\_L\_OUT1**

**SPK\_R\_OUT1:** Speaker Connector

PIN	ASSIGNMENT
1	SPKR_P
2	SPKR_M

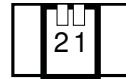

**SPK\_R\_OUT1**

# ***SOFTWARE UTILITIES***

CHAPTER

**3**

This chapter comprises the detailed information of VGA driver, LAN driver, and Sound driver.

Section includes:

- Introduction
- Intel® Chipset Software Installation Utility
- VGA Driver Utility
- LAN Driver Utility
- Sound Driver Utility
- Touchscreen Driver Utility

### 3-1. INTRODUCTION

Enclosed with our SP-7117 package, you will find a CD ROM disk containing all types of drivers we have. As a SP-7117 user, you will only need some of files contained in the CD ROM disk, please take note of the following chart:

<b>FILE NAME</b> <b>(Assume that CD ROM drive is D:)</b>	<b>PURPOSE</b>
D:\Driver\Plaform\[OS]\MainChip	Intel® Chipset Device Software installs Windows INF files to the target system.
D:\Driver\Plaform\[OS]\VGA	Intel® HD Graphics installer for Embedded Media and Graphics Driver installation
D:\Driver\Plaform\[OS]\LAN	Realtek RTL8111F for LAN driver installation
D:\Driver\Plaform\[OS]\SOUND	Realtek ALC888S High Definition Audio for sound driver installation
D:\Driver\Device\Touch Screen	eGalax Touch Controller for Windows installation
D:\Driver\Flash BIOS	AMI BIOS update utility

**Note:** Be sure to install the Utility right after the OS is fully installed.

## **3-2. INTEL® CHIPSET SOFTWARE INSTALLATION UTILITY**

### **3-2-1. Introduction**

The Intel® Chipset Device Software installs Windows \*.INF files to the target system. These files outline to the operating system how to configure the Intel® chipset components in order to ensure that the following features function properly:

- PCIe Support
- SATA Storage Support
- USB Support
- Identification of Intel® Chipset Components in the Device Manager

### **3-2-2. Installation of Utility for Windows 7**

The Utility Pack is made only for Windows 7. It should be installed right after the OS installation; kindly follow the following steps:

1. Place insert the Utility Disk into the CD ROM drive.
2. Under Windows system, go to the directory where Utility Disc is located.  
e.g.: D:\Driver\Platform\OS\Utility\infinst\_autol.exe
3. Click infinst\_autol.exe file for utility installation.
4. Follow the instructions on the screen to complete the installation.
5. Once installation is completed, shut down the system and restart in order for the changes to take effect.



### 3-3. VGA DRIVER UTILITY

The VGA interface is embedded with our SP-7117 system to support CRT display. The following illustration briefly shows you the content of VGA driver.

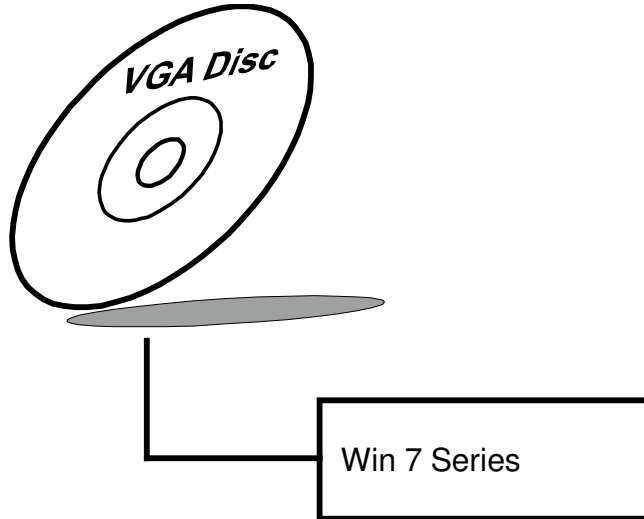

#### 3-3-1. Installation of VGA Driver for Windows 7

1. Start the computer.
2. Insert the Utility Disk into the CD ROM drive.
3. Open the VGA folder for your system to choose an appropriate folder, and double-click "\*.exe" file to install.  
e.g. D:\Driver\Platform\(\OS)\Graphics\Your system\ \*\*\*.exe  
(If D is not your CD-ROM drive, substitute D with the correct drive letter.)
4. Follow the Wizard's on-screen instructions to complete the installation.

## 3-4. LAN DRIVER UTILITY

### 3-4-1. Introduction

The SP-7117 is enhanced with LAN function that can support various network adapters. The content of the LAN driver is found as follows:

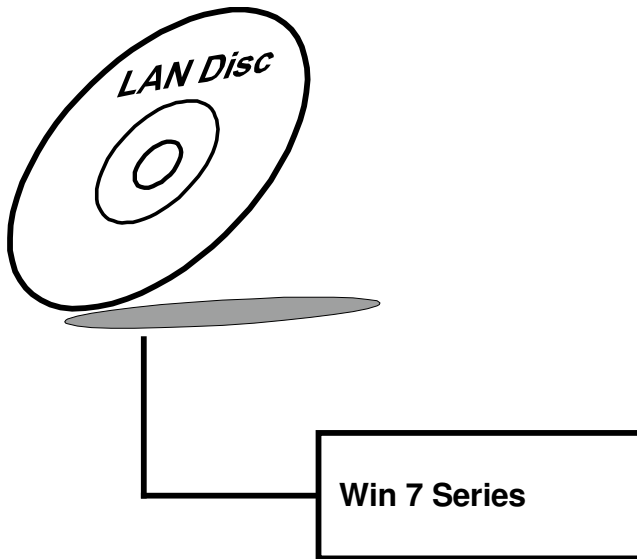

For more details on Installation procedure, please refer to Readme.txt file found on LAN DRIVER UTILITY.

## 3-5. SOUND DRIVER UTILITY

### 3-5-1. Introduction

The Audio chip enhanced in this system is fully compatible with Windows 7. Below, you will find the content of the Sound driver:

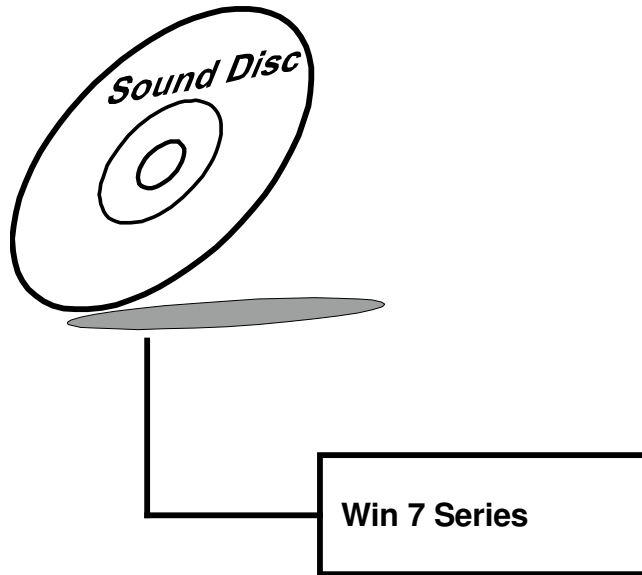

### 3-5-2. Installation Procedure for Windows 7

1. Open the "Sound" folder. For your system to choose an appropriate folder, and Run the setup.exe program to start the installation.  
e.g.: D:\Driver\Platform\(\OS)\ SOUND\Your system\setup.exe  
(If D is not your CD-ROM drive, substitute D with the correct drive letter.)
2. Click on [Next] to continue the procedure. If the Windows popup "Windows can't verify the publisher of this driver software" message, press "Install this driver software anyway" to continue the installation.
3. Finally, select to restart the system and press [Finish] to complete the installation.

### 3-6. TOUCHSCREEN DRIVER UTILITY

The touch screen driver utility can only be installed on Windows 7, and it should be installed right after the OS installation.

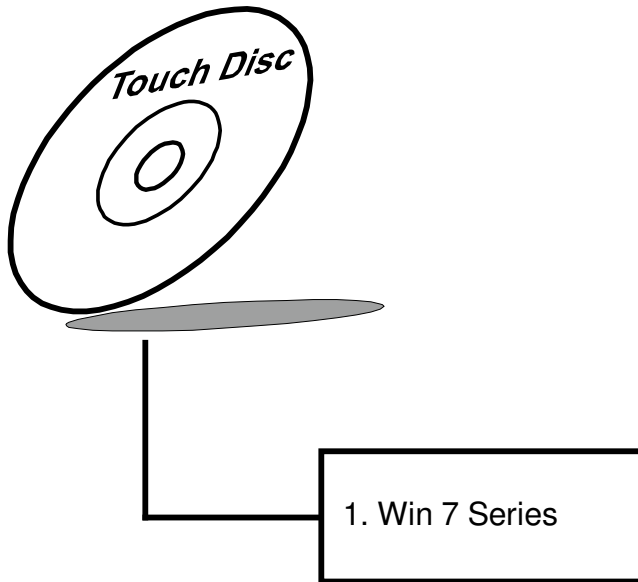

#### 3-6-1. Installation of Touchscreen Driver

To install the touchscreen driver, follow the steps below:

1. Open the “Device/Touchscreen” folder where the touchscreen driver is located.
2. Click **Setup.exe** file for driver installation.
3. Follow the on-screen instructions to complete the installation.
4. Once installation is completed, shut down the system and restart for the changes to take effect.

# ***BIOS SETUP***

This chapter shows how to set up the AMI BIOS.

Section includes:

- Introduction
- Entering Setup
- Main
- Advanced
- Chipset
- Boot
- Security
- Save & Exit

## 4-1. INTRODUCTION

The system SP-7117 uses an AMI (American Megatrends Incorporated) Aptio BIOS that is stored in the Serial Peripheral Interface Flash Memory (4MB SPI Flash) and can be updated. The SPI Flash contains the BIOS (Basic Input Output System) setup menu, Power-on Self-test (POST), the PCI auto-configuration utility, LAN EEPROM information, and Plug and Play support.

Aptio is AMI's BIOS firmware based on the UEFI (Unified Extensible Firmware Interface) specifications and the Intel Platform Innovation Framework for EFI. The UEFI specification defines an interface between an operating system and platform firmware. The interface consists of data tables that contain platform-related information, boot service calls, and runtime service calls that are available to the operating system and its loader. These provide standard environment for booting an operating system and running pre-boot applications.

Following illustration shows Extensible Firmware Interface's position in the software stack.

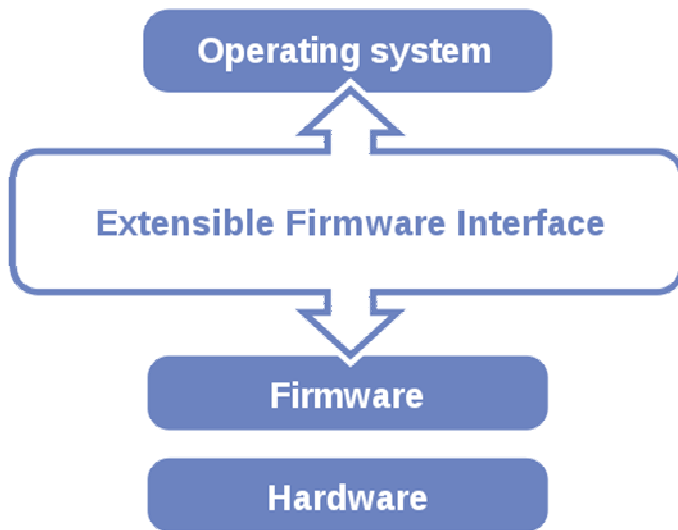

EFI BIOS provides an user interface allow users the ability to modify hardware configuration, e.g. change system date and time, enable or disable a system component, decide bootable device priorities, setup personal password, etc., which is convenient for modifications and customization of the computer system and allows technicians another method for finding solutions if hardware has any problems.

The BIOS setup menu can be used to view and change the BIOS settings for the computer. The BIOS setup menu is accessible by pressing the <Del> or <F2> key on keyboard during the POST stage, right before the operating system is loading. All the settings are described in chapter to be followed.

## **4-2. ENTERING SETUP**

When the system is powered on, the BIOS will enter the Power-on Self-test (POST) routines and the following message will appear on the lower screen:



**First POST screen with AMI logo**

For as long as this message is present on the screen before the operating system boot begins, you may press the <Del> or <F2> key (the one that shares the decimal point at the bottom of the number keypad) to access the setup menu. In a moment, the main menu of the Aptio Setup Utility will appear on the screen:



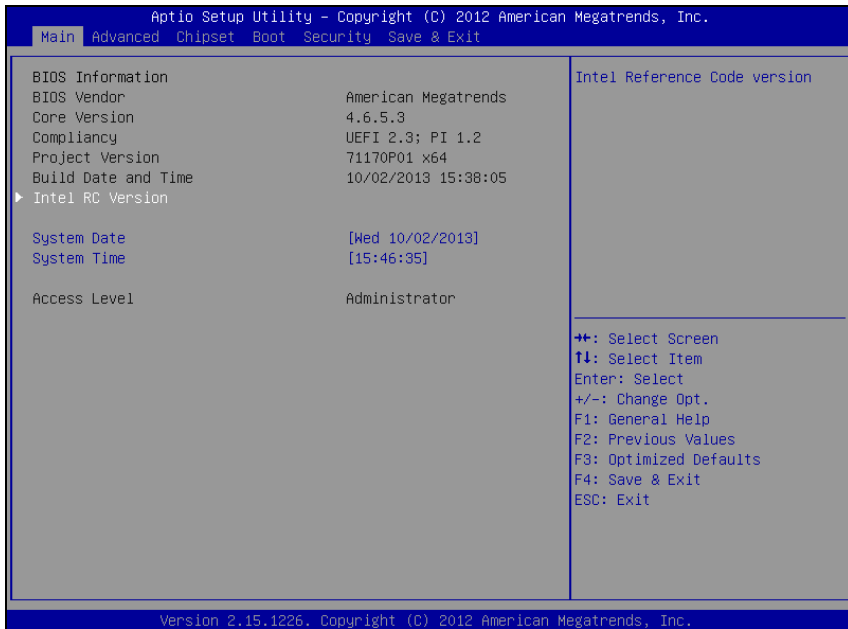

**BIOS setup program initial screen**

The BIOS setup menu interface and help messages are shown in US English. You may move the cursor by up/down keys to highlight the individual menu items. As you highlight each item, a brief description of the highlighted selection will appear at the bottom of the screen.

### 4-2-1. BIOS Setup Menu Keys

The following table provides list of keys available for BIOS setup menu.

<b>BIOS Setup menu key</b>	<b>Description</b>
<<-> and <->>	Selects a different menu screen (moves the selection left or right).
<↑> and <↓>	Selects an item (moves the selection up or down).
<Enter>	Executes command or selects the sub-menu.
<F2>	Load the previous configuration values.
<F3>	Load the default configuration values.
<F4>	Save the current values and exits the BIOS setup menu.
<Esc>	Leaves the sub-menu. Triggers confirmation to exit BIOS setup menu.

### 4-2-2. BIOS Messages

This section describes error messages generated by the board's BIOS. These messages would be displayed on the monitor when certain recoverable error/event occurs during POST stage. The table below gives an explanation of the BIOS messages.

<b>BIOS Setup menu key</b>	<b>Explanation</b>
A first boot or NVRAM reset condition has been detected.	BIOS has been updated or the battery was replaced.
The CMOS defaults were loaded.	Default values have been loaded after the BIOS was updated or the battery was replaced.
The CMOS battery is bad or was recently replaced.	The battery may be losing power, replace the battery soon. Also, this message is displayed once the new battery was placed.

## 4-3. MAIN

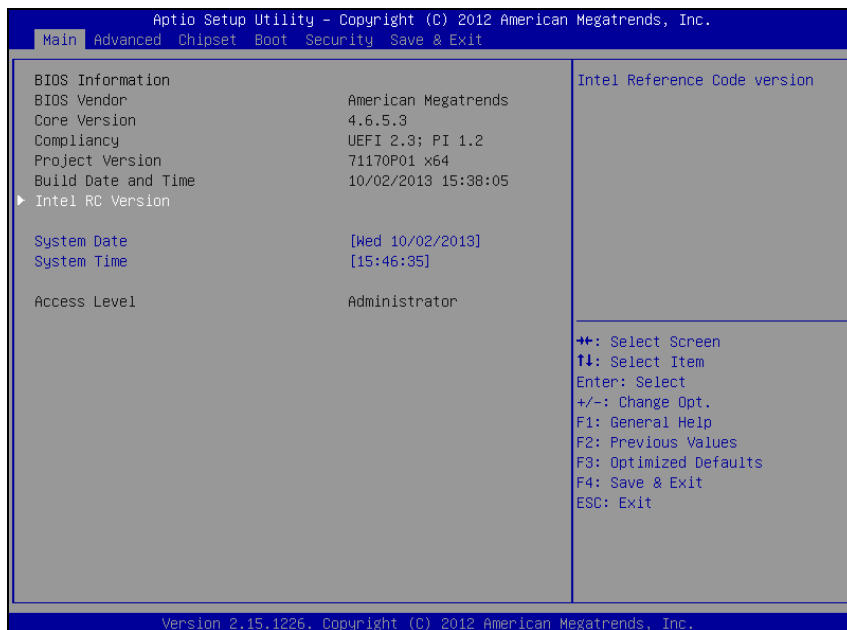

Main screen

BIOS Setting	Options	Description/Purpose
BIOS Vendor	No changeable options	Displays the BIOS vendor.
Core Version	No changeable options	Displays the current BIOS core version.
Compliancy	No changeable options	Displays the current UEFI version.
Project Version	No changeable options	Displays the version of the BIOS and its architecture compatibility currently installed on the platform.
Build Date and Time	No changeable options	Displays the date of current BIOS version.
Intel RC Version	Sub-menu	Enters sub-menu with information regarding used components versions.
System Date	Month, day, year	Specifies the current date.
System Time	Hour, minute, second	Specifies the current time.
Access Level	No changeable options	Displays security levels currently in use.

## 4-3-1. Main – Intel RC Version



Intel RC Version screen

BIOS Setting	Options	Description/Purpose
Intel Cedarview	No changeable options	Displays code version for Intel D/N2x00 processor.
Intel MRC	No changeable options	Displays code version of Intel Memory Reference Code (MRC), e.g. "1.12".
Intel NM10	No changeable options	Displays code version for Intel NM10 chipset.
Intel P-UNIT	No changeable options	Displays code version for power unit.
Intel iGFX VBIOS	No changeable options	Displays current version of Intel Video BIOS (VBIOS), e.g. "1089".
Intel ACPI	No changeable options	Displays code version for Advanced Configuration and Power Interface (ACPI).

## 4-4. ADVANCED

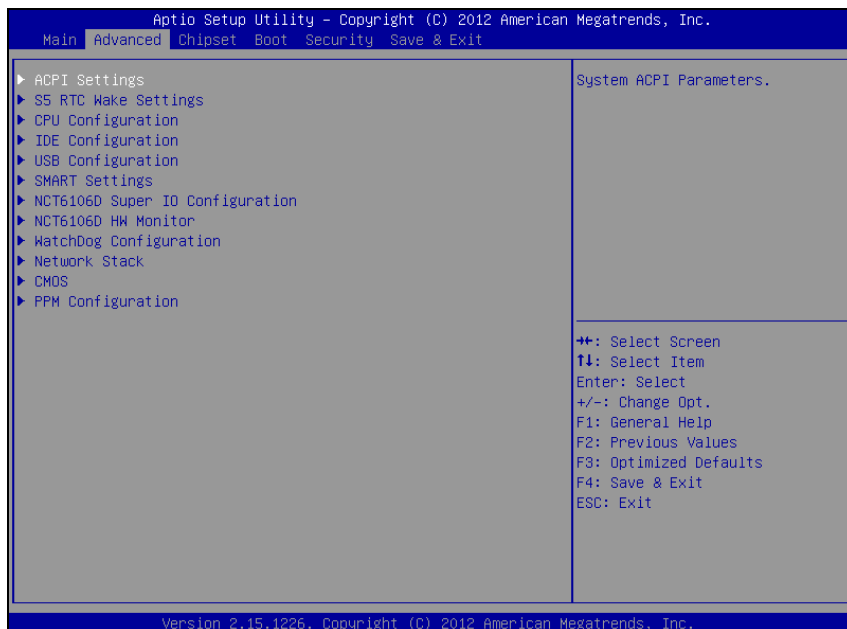

Advanced screen

BIOS Setting	Options	Description/Purpose
ACPI Settings	Sub-menu	Enters menu to set ACPI option.
S5 RTC Wake Settings	Sub-menu	Accesses settings for scheduled S5 power on feature.
CPU Configuration	Sub-menu	All processor basic options menu.
IDE Configuration	Sub-menu	SATA device configuration section.
USB Configuration	Sub-menu	Enters menu to configure USB options.
SMART Settings	Sub-menu	Section to SATA HDD/SSD S.M.A.R.T. capability.
NCT6106D Super IO Configuration	Sub-menu	Serial and parallel ports configuration section.

<b>BIOS Setting</b>	<b>Options</b>	<b>Description/Purpose</b>
NCT6106D HW Monitor	Sub-menu	Options for NCT6106D hardware monitor chip.
WatchDog Configuration	Sub-menu	Section to configure Watchdog timer.
Network Stack	Sub-menu	Enters menu to enable network during DXE stage and UEFI shell environment.
CMOS	Sub-menu	Options for CMOS battery.
PPM Configuration	Sub-menu	Processor advanced power options menu.

## 4-4-1. Advanced – APCI Settings

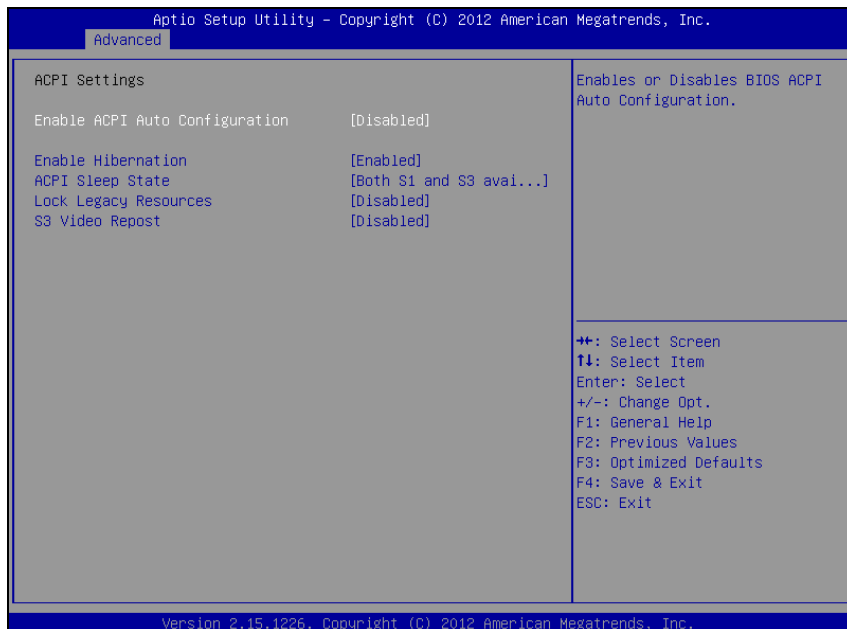

APCI Settings screen

BIOS Setting	Options	Description/Purpose
Enable ACPI Auto Configuration	-Disabled -Enabled	Allows deciding whether ACPI settings are configured by operating system or manually (option disabled).
Enable Hibernation	-Disabled -Enabled	Enables ability to enter S4 state (to be able to hibernate in Windows operating system).
ACPI Sleep State	-Suspend Disabled -S1 only -S3 only -Both S1 and S3	Specifies the ACPI sleep state. <ul style="list-style-type: none"> <li>▪ <b>Disabled</b> option disables ACPI sleep feature.</li> <li>▪ <b>S1</b> is less common state in which the CPU is stopped.</li> <li>▪ <b>S3</b> allows the platform to enter Sleep mode (also known as Standby or Suspend to RAM).</li> </ul>

<b>BIOS Setting</b>	<b>Options</b>	<b>Description/Purpose</b>
Lock Legacy Resources	-Disabled -Enabled	Prevents the operating system from changing resources to serial or parallel controller.
S3 Video Repost	-Disabled -Enabled	If enabled re-initialises the VBIOS after waking up from an S3 sleep.

**Note:** It is necessary to modify system registry in order enable wake up from S3 system power state via USB devices in Windows XP.

Simply add DWORD entry named “USBBIOSx” with value 0 to location:

HKEY\_LOCAL\_MACHINE\SYSTEM\CurrentControlSet\Services\usb\

For more details, refer to Microsoft Support article KB 841858 at

<http://support.microsoft.com/kb/841858>.



4-4-2. Advanced – S5 RTC Wake Settings [disabled]

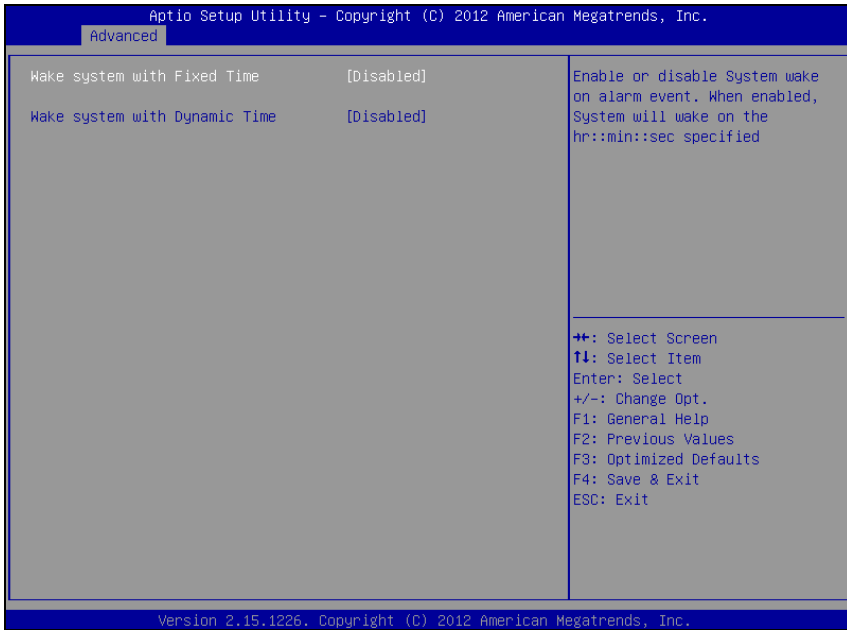

S5 RTC wake setting screen

BIOS Setting	Options	Description/Purpose
Wake system with Fixed Time	-Disabled -Enabled	Allows enabling scheduled S5 to S0 transition set to specific period of time (option enabled). Please note that only one of these two options can be enabled at the same moment.
Wake system with Dynamic Time	-Disabled -Enabled	Allows enabling scheduled S5 to S0 transition set to variable period of time (option enabled).

4-4-3. Advanced – S5 RTC Wake Settings [enabled]

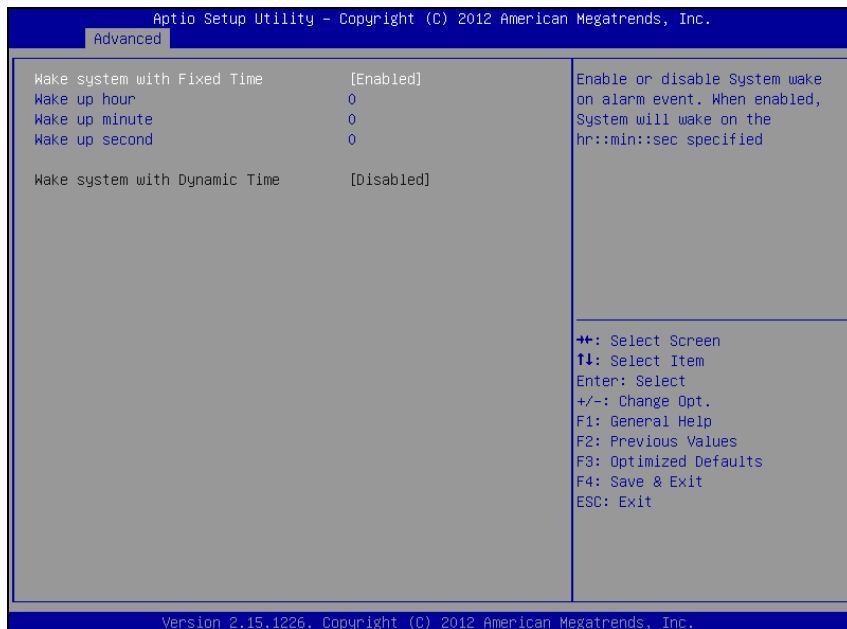

S5 RTC wake setting screen

BIOS Setting	Options	Description/Purpose
Wake system with Fixed Time	-Disabled -Enabled	Allows enabling scheduled S5 to S0 transition set to specific period of time (option enabled). Please note that only one of these two options can be enabled at the same moment.
Wake up hour	Multiple options ranging from 0 to 23	Sets an hour for schedule power on event.
Wake up minute	Multiple options ranging from 0 to 59	Sets a minute for schedule power on event.
Wake up second	Multiple options ranging from 0 to 59	Sets a second for schedule power on event.

<b>BIOS Setting</b>	<b>Options</b>	<b>Description/Purpose</b>
Wake system with Dynamic Time	-Disabled -Enabled	Allows enabling scheduled S5 to S0 transition set to variable period of time (option enabled).
Wake up minute increase	Multiple options ranging from 1 to 5	Sets a period of time (in minutes) after which the board wakes up from S5 state.

4-4-4. Advanced - CPU Configuration



CPU Configuration screen

BIOS Setting	Options	Description/Purpose
Processor Type	No changeable options	Displays the current processor model number and frequency.
Processor Stepping	No changeable options	Displays the D/N2x000 processor stepping.
EMT64	No changeable options	Reports if processor supports Intel x86-64 (amd64) implementation.
Processor Speed	No changeable options	Displays the current processor frequency.
System Bus Speed	No changeable options	Displays the bus frequency.
Ratio Status	No changeable options	Displays the processor model bus/core ratio.
Actual Ration	No changeable options	Displays the processor current bus/core ratio.

<b>BIOS Setting</b>	<b>Options</b>	<b>Description/Purpose</b>
Processor Stepping	No changeable options	Displays processor's ID stepping.
Microcode Revision	No changeable options	Displays processor's microcode update revision.
L1 Cache RAM	No changeable options	Displays amount of Level 1 cache.
L2 Cache RAM	No changeable options	Displays amount of Level 2 cache.
Processor Cores	No changeable options	Displays information about number of physical cores in processor.
Hyper-Threading	No changeable options	Reports if Intel Hyper-Threading Technology is supported by processor.
Hyper-threading	-Disabled -Enabled	When disabled, only one thread per active core will operate.
Execute Disable Bit	-Disabled -Enabled	Enables the NX bit (No eXecute) security feature.
Limit CPUID Maximum	-Disabled -Enabled	Enables for legacy operating systems to boot processors with extended CPUID (CPU Identification) functions.

4-4-5. Advanced – IDE Configuration [enabled]

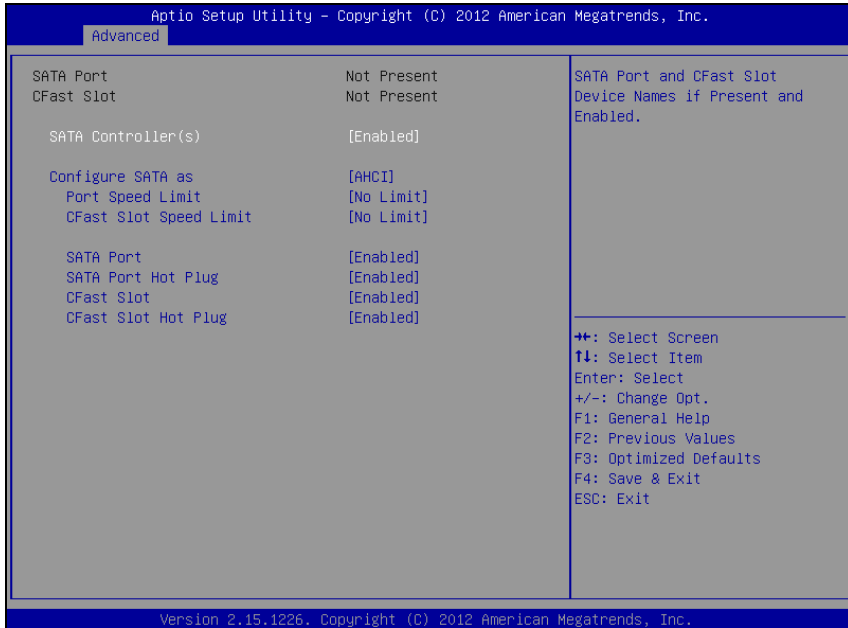

IDE configuration screen

BIOS Setting	Options	Description/Purpose
SATA Port	No changeable options	Displays device ID plugged in SATA port (if any).
CFAST Slot	No changeable options	Displays device ID plugged in CFAST slot (if any).
SATA Controller(s)	-Disabled -Enabled	Enables SATA controller.
Configure SATA as	-IDE -AHCI	Configures SATA devices as IDE or AHCI. It is not advised to change this option once the operating system is installed.
Port Speed Limit	-No Limit -Gen1 -Gen2	Configures SATA (only when set as AHCI) interface as following: <ul style="list-style-type: none"> <li>▪ <b>No Limit</b> selects no speed limitation.</li> <li>▪ <b>Gen1</b> mode sets the device to 1.5 Gbit/s</li> </ul>

BIOS Setting	Options	Description/Purpose
		<p>speed.</p> <ul style="list-style-type: none"> <li>▪ <b>Gen2</b> mode sets the device to 3 Gbit/s speed (in case it is compatible).</li> </ul>
CFast Slot Speed Limit	-No Limit -Gen1 -Gen2	<p>Configures CFAST (only when set as AHCI) interface as following:</p> <ul style="list-style-type: none"> <li>▪ <b>No Limit</b> selects no speed limitation.</li> <li>▪ <b>Gen1</b> mode sets the device to 1.5 Gbit/s speed.</li> <li>▪ <b>Gen2</b> mode sets the device to 3 Gbit/s speed (in case it is compatible).</li> </ul>
SATA Port	-Disabled -Enabled	Allows controlling specific SATA port.
SATA Port Hot Plug	-Disabled -Enabled	Enables Hot Plug feature on SATA port (if supported by the device).
CFast Slot	-Disabled -Enabled	Allows controlling specific CFAST Slot.
CFast Slot Hot Plug	-Disabled -Enabled	Enables Hot Plug feature on CFAST slot (if supported by the device).

4-4-6. Advanced – IDE Configuration [disabled]

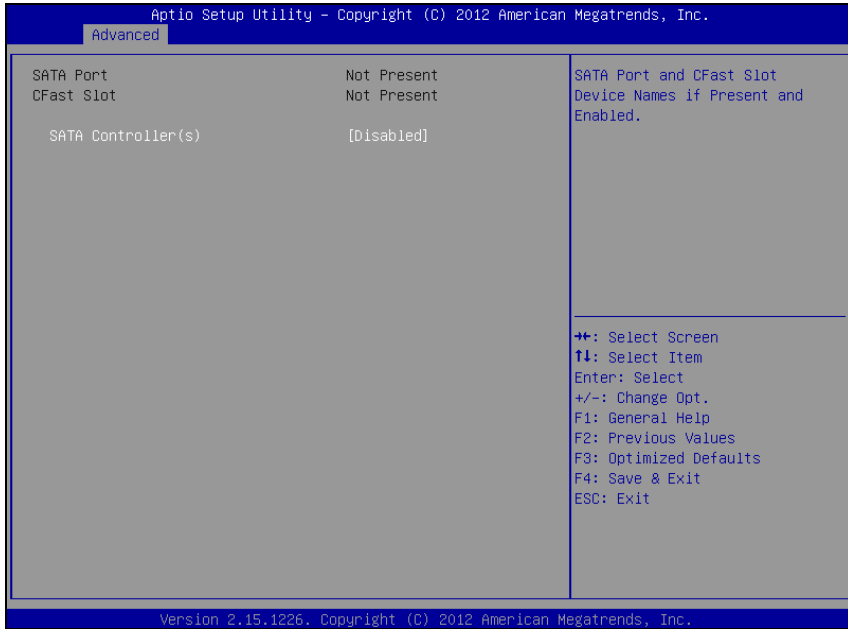

IDE configuration screen

BIOS Setting	Options	Description/Purpose
SATA Port0	No changeable options	Displays device ID plugged in SATA port (if any).
SATA Controller(s)	-Disabled -Enabled	Disables SATA controller.



4-4-7. Advanced – USB Configuration

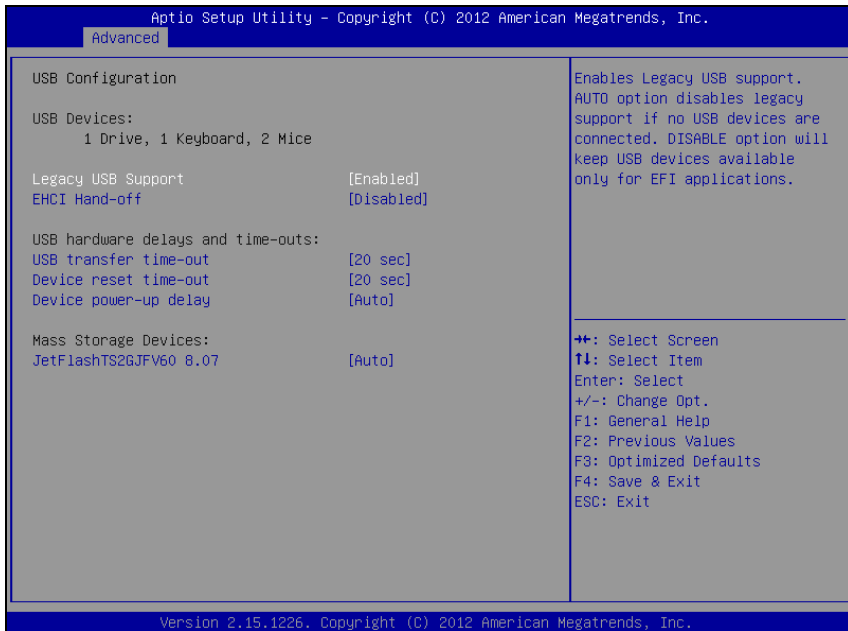

USB Configuration screen

BIOS Setting	Options	Description/Purpose
USB Devices	No changeable options	Reports number and type of connected USB devices (if any).
Legacy USB Support	-Disabled -Enabled -Auto	Enables support for USB in legacy operating systems (e.g. MS-DOS, Windows NT).
EHCI Hand-off	-Disabled -Enabled	When enabled it allows BIOS support control of the EHCI controller and the OS hand-off synchronization capability.
USB transfer time-out	-1 sec -5 sec -10 sec -20 sec	Specifies time-out value for Control, Bulk and Interrupt transfers.

<b>BIOS Setting</b>	<b>Options</b>	<b>Description/Purpose</b>
Device reset time-out	-10 sec -20 sec -30 sec -40 sec	Specifies the value for device reset timeout.
Device power-up delay	-Auto -Manual	Specifies maximum time it would take for USB device to report itself to the controller.  If set to auto, it would use default values (100 ms for root port) and value read from hub descriptor in case of hub port.
Mass Storage Devices: [drive(s)]	-Auto -Floppy -Forced FDD -Hard Disk -CD-ROM	Appears only when USB flash drive is plugged in. Allows selecting which emulation to use on available drive(s).  Please note that the sector size of your USB drive should be emulated device native sector size.

4-4-8. Advanced – SMART Settings

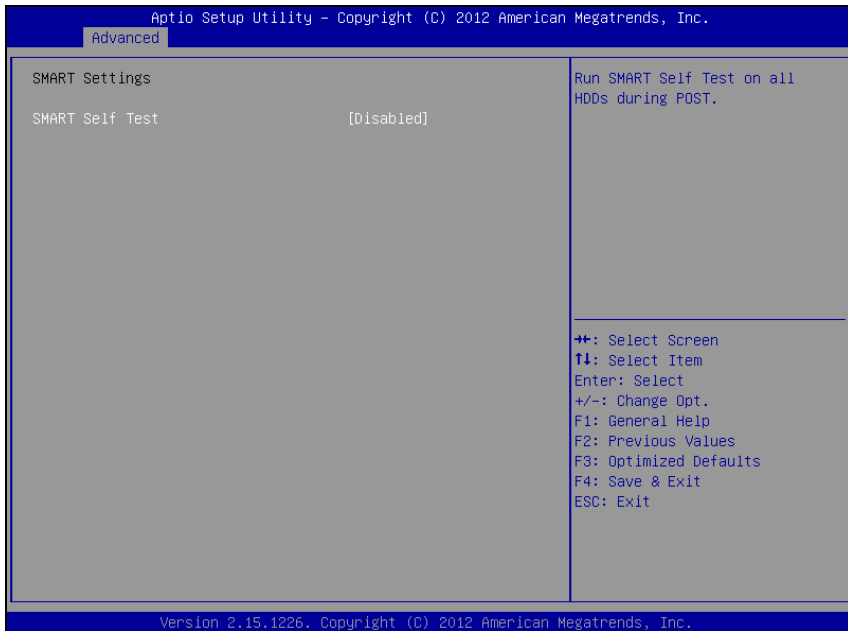

SMART Settings screen

BIOS Setting	Options	Description/Purpose
SMART Self Test	-Disabled -Enabled	Enables S.M.A.R.T. (Self-Monitoring, Analysis and Reporting Technology) feature to be found on most modern HDD/SSD.

4-4-9. Advanced – NCT6106D Super IO Configuration

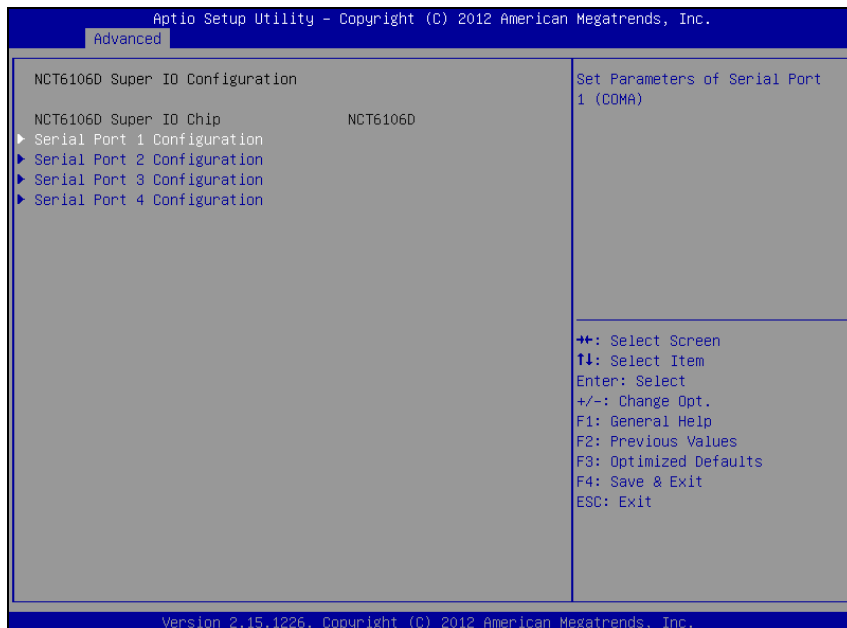

NCT6106D Super IO Configuration screen

BIOS Setting	Options	Description/Purpose
NCT6106D Super IO Chip	No changeable options	Shows Super IO manufacturer and model.
Serial Port 1 Configuration	Sub-menu	Enters menu to configure serial port 1.
Serial Port 2 Configuration	Sub-menu	Enters menu to configure serial port 2.
Serial Port 3 Configuration	Sub-menu	Enters menu to configure serial port 3.
Serial Port 4 Configuration	Sub-menu	Enters menu to configure serial port 4.

4-4-9-1. NCT6106D Super IO Configuration – Serial Port 1 Configuration

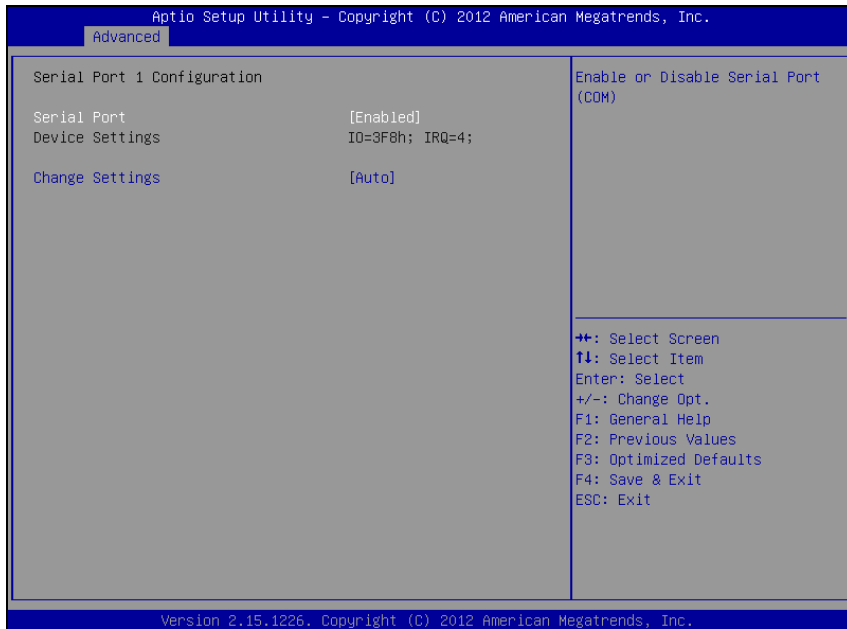

Serial Port 1 Configuration screen

BIOS Setting	Options	Description/Purpose
Serial Port	-Disabled -Enabled	Configures the serial port 1.
Device Settings	No changeable options	Shows current settings applied to the serial port.
Change Settings	-Auto -IO=3F8h; IRQ=4; -IO=3F8h; IRQ=3,4,5,6,7,10,11,12; -IO=2F8h; IRQ=3,4,5,6,7,10,11,12; -IO=3E8h; IRQ=3,4,5,6,7,10,11,12; -IO=2E8h; IRQ=3,4,5,6,7,10,11,12;	Specifies the base I/O address and interrupt request for the serial port 1 if enabled.

4-4-9-2. NCT6106D Super IO Configuration – Serial Port 2 Configuration

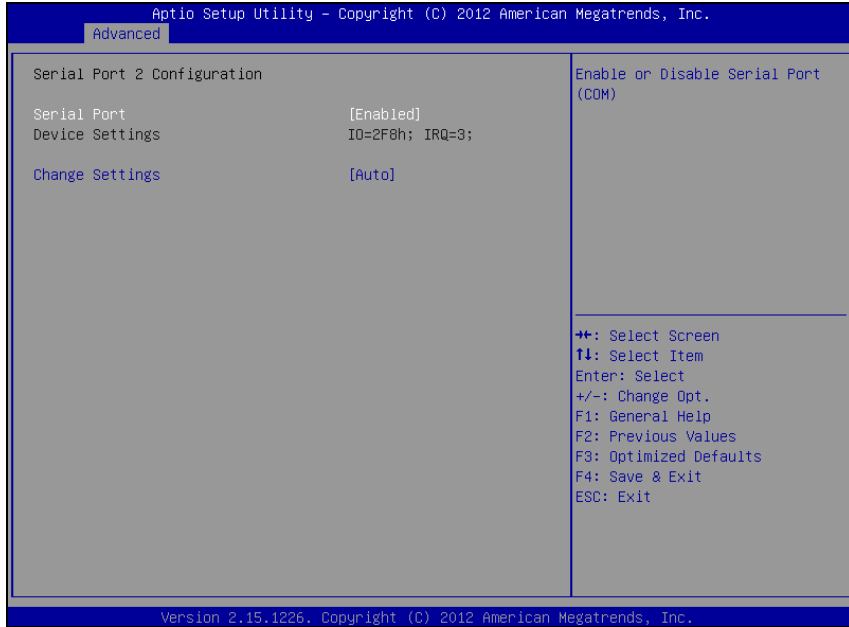

Serial Port 2 Configuration screen

BIOS Setting	Options	Description/Purpose
Serial Port	-Disabled -Enabled	Configures the serial port 2.
Device Settings	No changeable options	Shows current settings applied to the serial port.
Change Settings	-Auto -IO=3F8h; IRQ=4; -IO=3F8h; IRQ=3,4,5,6,7,10,11,12; -IO=2F8h; IRQ=3,4,5,6,7,10,11,12; -IO=3E8h; IRQ=3,4,5,6,7,10,11,12; -IO=2E8h; IRQ=3,4,5,6,7,10,11,12;	Specifies the base I/O address and interrupt request for the serial port 2 if enabled.

4-4-9-3. NCT6106D Super IO Configuration – Serial Port 3 Configuration

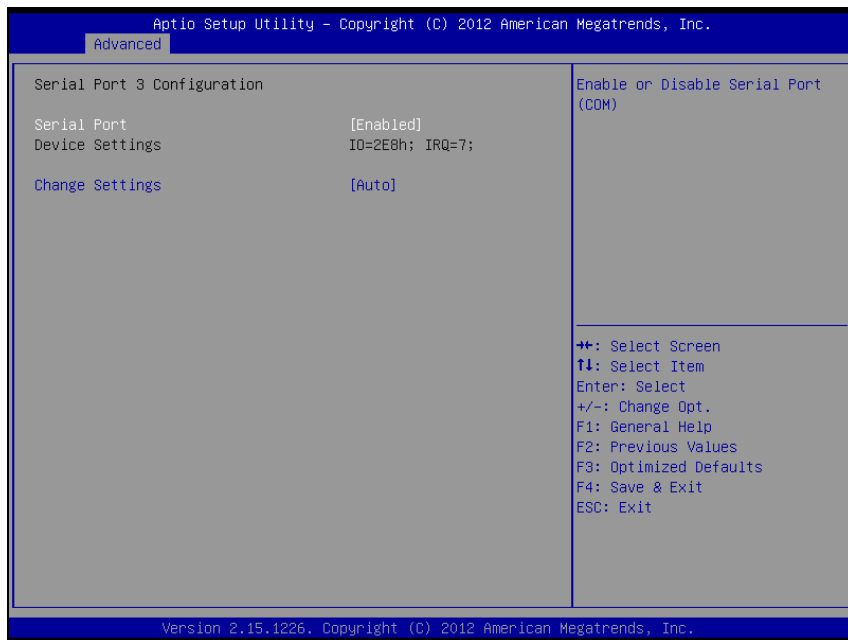

Serial Port 3 Configuration screen

BIOS Setting	Options	Description/Purpose
Serial Port	-Disabled -Enabled	Configures the serial port 3.
Device Settings	No changeable options	Shows current settings applied to the serial port.
Change Settings	-Auto -IO=3F8h; IRQ=4; -IO=3F8h; IRQ=3,4,5,6,7,10,11,12; -IO=2F8h; IRQ=3,4,5,6,7,10,11,12; -IO=3E8h; IRQ=3,4,5,6,7,10,11,12; -IO=2E8h; IRQ=3,4,5,6,7,10,11,12;	Specifies the base I/O address and interrupt request for the serial port 3 if enabled.

4-4-9-4. NCT6106D Super IO Configuration –Serial Port 4 Configuration



Parallel Port Configuration screen

BIOS Setting	Options	Description/Purpose
Serial Port	-Disabled -Enabled	Configures the serial port 4.
Device Settings	No changeable options	Shows current settings applied to the serial port.
Change Settings	-Auto -IO=3F8h; IRQ=4; -IO=3F8h; IRQ=3,4,5,6,7,10,11,12; -IO=2F8h; IRQ=3,4,5,6,7,10,11,12; -IO=3E8h; IRQ=3,4,5,6,7,10,11,12; -IO=2E8h; IRQ=3,4,5,6,7,10,11,12;	Specifies the base I/O address and interrupt request for the serial port 4 if enabled.



## 4-4-10. Advanced – NCT6106D HW Monitor

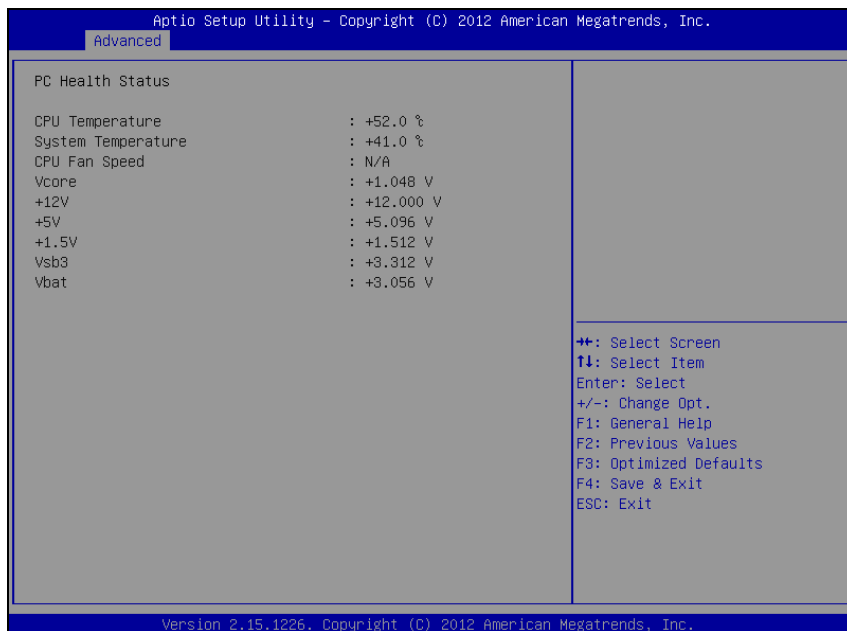

NCT6106D HW Monitor screen

BIOS Setting	Options	Description/Purpose
CPU Temperature	No changeable options	Shows processor temperature in degree Celsius.
System Temperature	No changeable options	Monitors system temperature in degree Celsius.
CPU Fan Speed	No changeable options	Monitors processor fan speed if connected (otherwise shows N/A).
Vcore	No changeable options	Shows actual voltage of processor core in volt.
+12V	No changeable options	Monitors 12V section (in volt).
+5V	No changeable options	Monitors 5V section (in volt).
+1.5V	No changeable options	Monitors 1.5V section (in volt).
Vsb3	No changeable options	Monitors 3.3V standby section (in volt).
Vbat	No changeable options	Monitors battery voltage (in volt).

### 4-4-11. Advanced – Watchdog Configuration

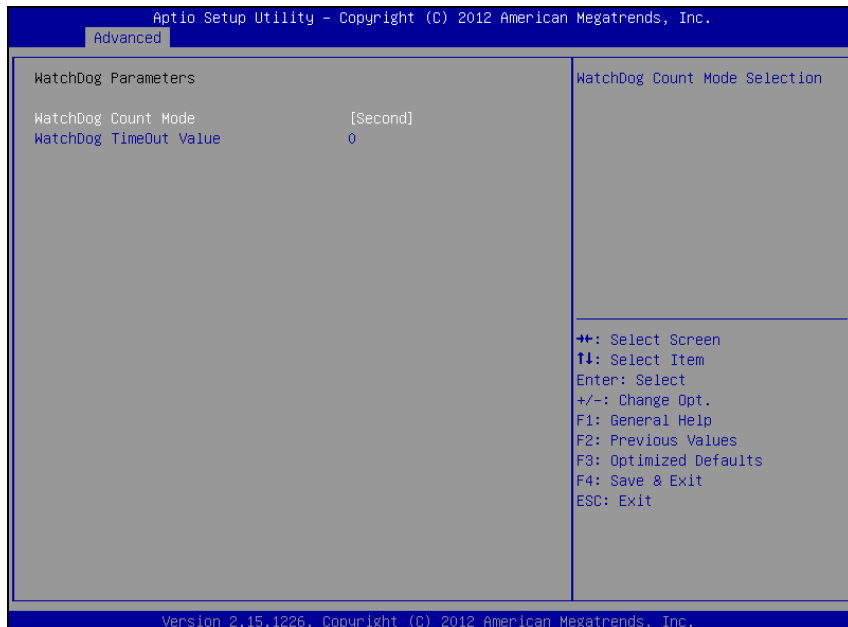

Watchdog Configuration screen

BIOS Setting	Options	Description/Purpose
Watchdog Timer	-Second -Minute	Selects time unit for watchdog timer feature.
WatchDog TimeOut Value	Multiple options ranging from 0 to 255	Sets the desired value (in seconds) for watchdog timeout. Setting value '0' means the watchdog is disabled.

4-4-12. Advanced – Network Stack

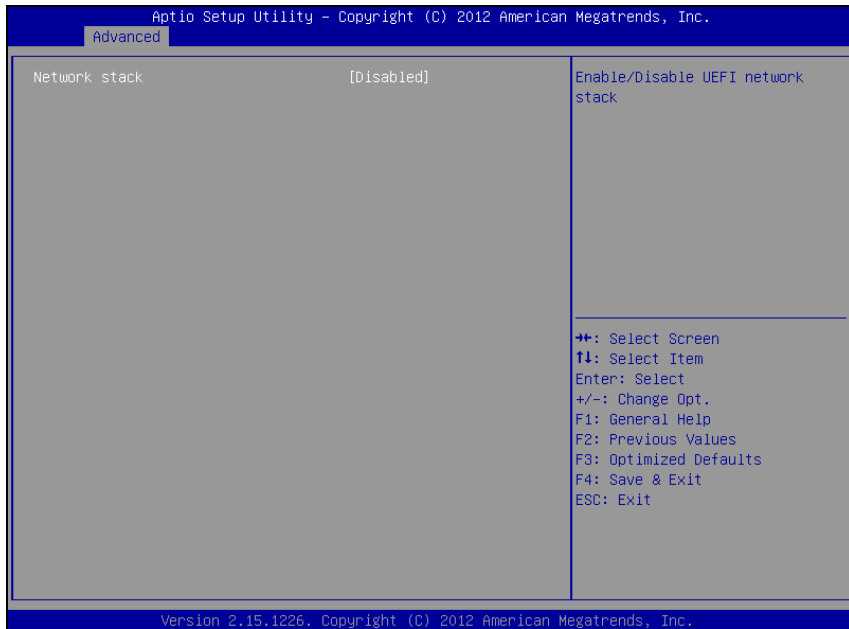

Network Stack screen

BIOS Setting	Options	Description/Purpose
Network stack	-Disabled -Enabled	Allows for enabling network capability in DXE stage and UEFI shell.

4-4-13. Advanced –CMOS

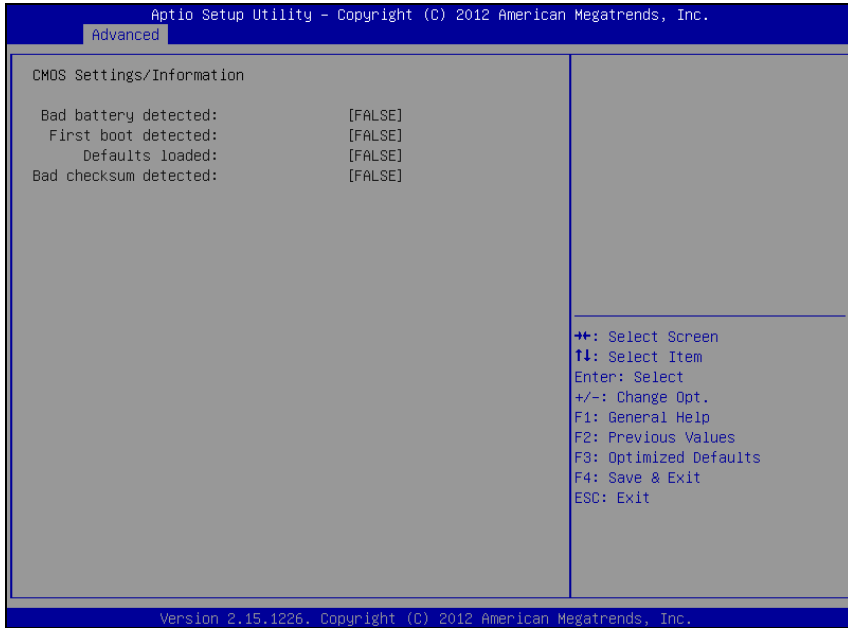

CMOS screen

BIOS Setting	Options	Description/Purpose
Bad battery detected	No changeable options	Informs about low voltage on CMOS backup battery. Please replace the battery.
First boot detected	No changeable options	Shows that this is first boot after updating BIOS.
Defaults loaded	No changeable options	Confirms that loaded default values has been selected and loaded.
Bad checksum detected	No changeable options	Informs about CMOS memory bad checksum.

4-4-14. Advanced –PPM Configuration

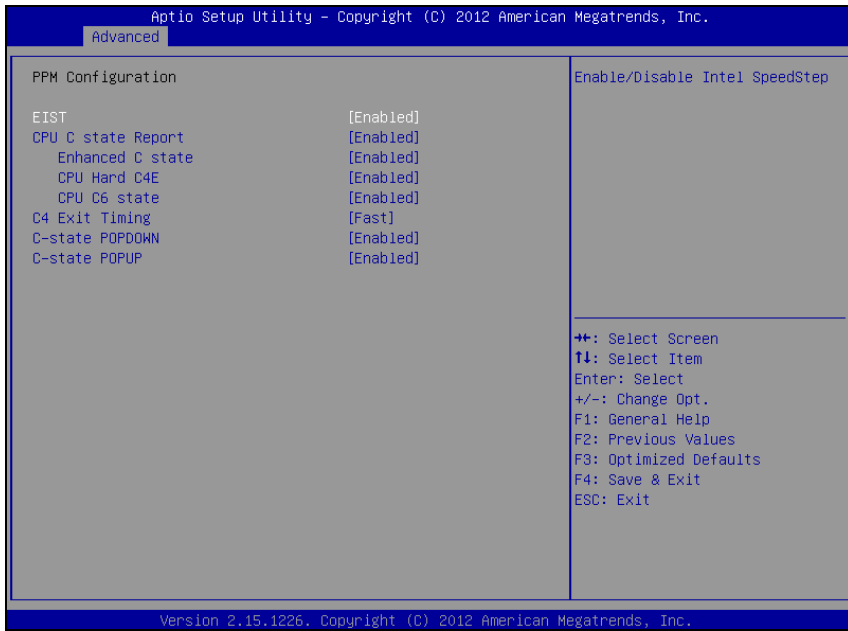

PPM Configuration screen

BIOS Setting	Options	Description/Purpose
EIST	-Disabled -Enabled	Enables Intel SpeedStep feature for dynamic scaling processor frequency.
CPU C state Report	-Disabled -Enabled	Enables C states mode as a measure to save power. In those states, the clock signal and power is cut from idle units.
Enhanced C state	-Disabled -Enabled	Enables enhanced C states, which allows cutting clock signal and reducing CPU voltage both at the same time.
CPU Hard C4E	-Disabled -Enabled	Enables enhanced deeper sleep in which reduces CPU voltage even more and turns off the cache.
CPU C6 State	-Disabled -Enabled	Enabled deep power down C state.

<b>BIOS Setting</b>	<b>Options</b>	<b>Description/Purpose</b>
C4 Exit Timing	-Default -Fast -Slow	Controls a programmable time for the CPU voltage to stabilize when exiting from C4 state. In case of perceptible audio noise caused by periodically exiting the C4 state option slow might eliminate the noise.
C-state POPDOWN	-Disabled -Enabled	When disabled, the CPU will no try to promote its sleep state from C2 down to C3/C4.; these last two items are part of PPM (Processor Power Management).
C-state POPUP	-Disabled -Enabled	Enables popup mode in which CPU goes from C3 or C4 state into C2 (when disabled it changes straight to C0).

## 4-5. Chipset



Chipset screen

BIOS Setting	Options	Description/Purpose
Host Bridge	Sub-menu	Enters menu to configure integrated graphics & memory related items.
South Bridge	Sub-menu	Enters menu to configure audio, USB and power lost items.

4-5-1. Chipset – Host Bridge

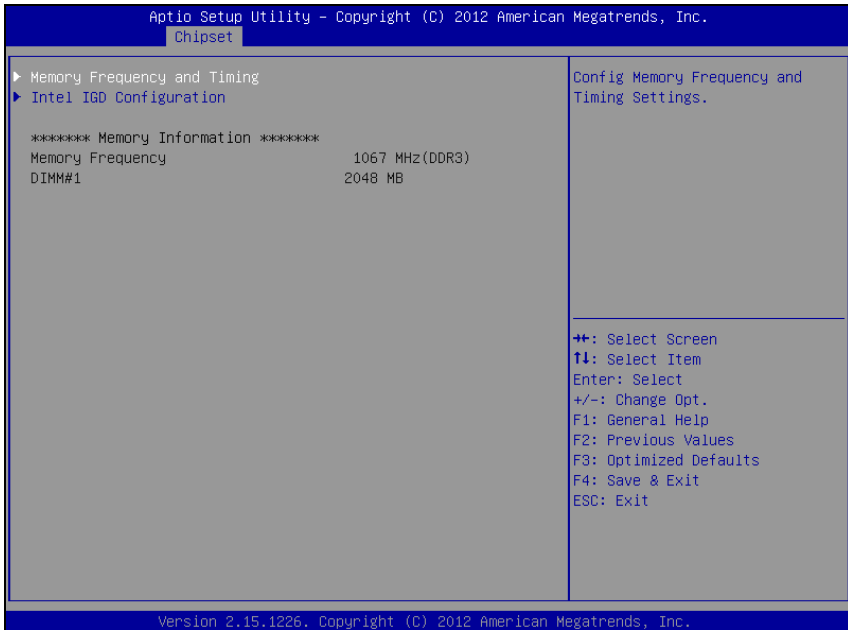

Host bridge screen

BIOS Setting	Options	Description/Purpose
Memory Frequency and Timing	Sub-menu	Enters menu to deal with memory setting.
Intel IGD Configuration	Sub-menu	Controls settings for integrated graphics device.
Memory Frequency	No changeable options	Displays current frequency for DDR3 memory, please note mobile processor model N2600 is limited to 800 MHz.
DIMM#1	No changeable options	Displays current amount of memory in DIMM slot, e.g. “1024 MB”.



4-5-1-1. Host Bridge –Memory Frequency and Timing



Memory Frequency and Timing screen

BIOS Setting	Options	Description/Purpose
MRC Fast Boot	-Disabled -Enabled	Selects MRC (Memory Reference Code) boot setting. Disabled MRC fast boot may help to resolve memory issues if encountered.

4-5-1-2. Host Bridge –Intel IGD Configuration



Intel IGD Configuration screen

BIOS Setting	Options	Description/Purpose
IGFX - Boot Type	-CRT -LVDS -CRT + LVDS -DVI-I	<p>Selects which screen is going to be active on power on.</p> <ul style="list-style-type: none"> <li>▪ In <b>CRT + LVDS</b> mode, if VGA monitor is connected, clone mode (both VGA display and LVDS panel show same content) is enabled.</li> <li>▪ <b>CRT</b> option selects output to VGA monitor only.</li> <li>▪ Similarly, <b>DVI-I</b> selects output to DVI monitor only.</li> </ul> <p>Please note, CRT and DVI-I outputs don't work simultaneously.</p>

4-5-2. Chipset – South Bridge

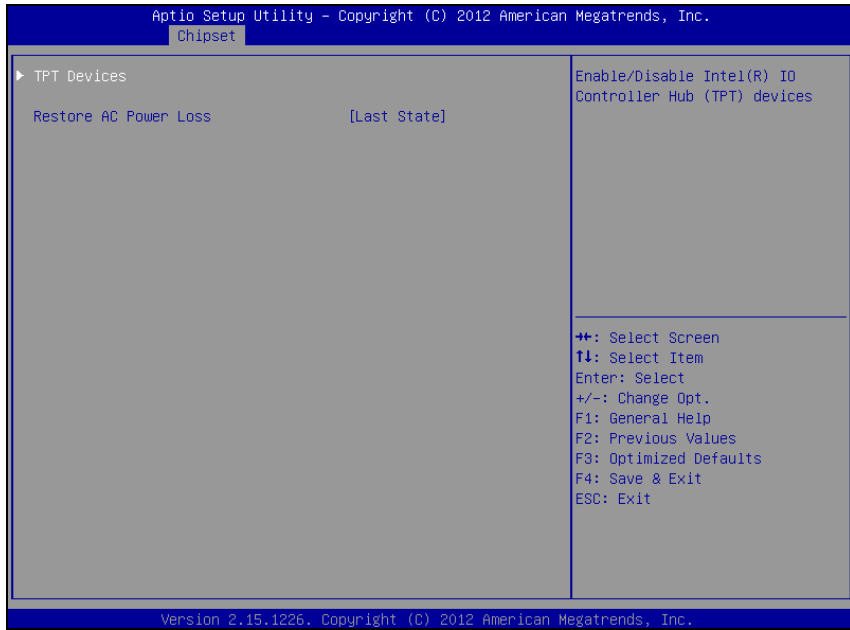

South Bridge screen

BIOS Setting	Options	Description/Purpose
TPT Devices	Sub-menu	Enters menu to configure audio and USB devices.
Restore AC Power Loss	-Power Off -Power On -Last State	Section to configure the board behavior if sudden loss of power should occur.

4-5-2-1. South Bridge – TPT Devices

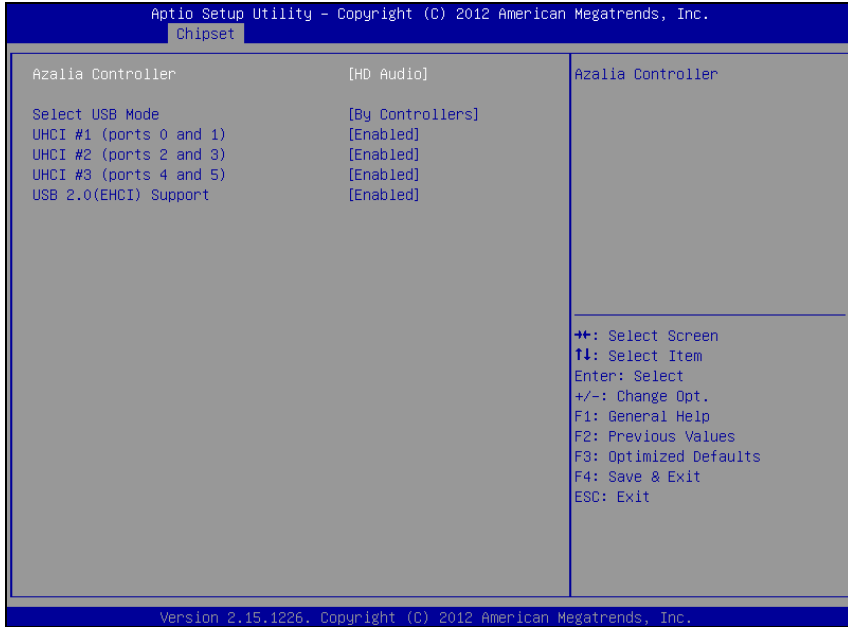

TPT device screen

BIOS Setting	Options	Description/Purpose
Audio Controller	-Disabled -HD Audio	Enables Intel HD audio controller.
Select USB Mode	-By Controllers -By Ports	Allows controlling USB ports from two different perspectives.
UHCI #1 (ports 0 and 1)	-Disabled -Enabled	Controls UHCI root port 1 (ports 0 and 1).
UHCI #2 (ports 2 and 3)	-Disabled -Enabled	Controls UHCI root port 2 (ports 2 and 3).
UHCI #3 (ports 4 and 5)	-Disabled -Enabled	Controls UHCI root port 3 (ports 4 and 5).
USB 2.0 (EHCI) Support	-Disabled -Enabled	Enables High Speed USB 2.0 on all ports.

## 4-6. Boot

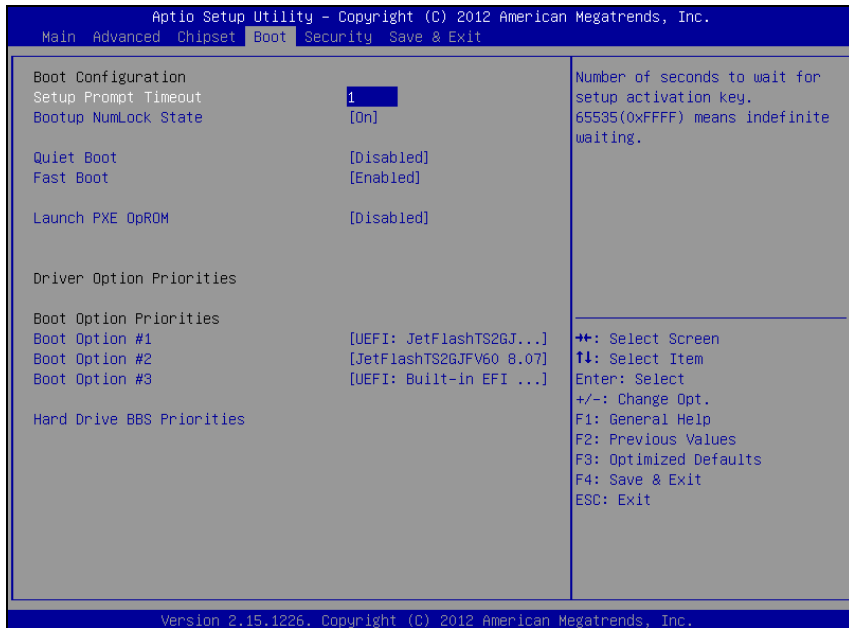

Boot screen

BIOS Setting	Options	Description/Purpose
Setup Prompt Timeout	multiple options ranging from 1 to 65535	Specifies number of seconds to wait for setup activation key (value 65535 results in indefinite waiting).
Bootup NumLock Status	-On -Off	Specifies the power-on state of the numlock feature on the numeric keypad of keyboard.
Quiet Boot	-Disabled -Enabled	When quiet boot is enabled, it displays AMI or OEM logo (if implemented) instead of POST messages during the boot.
Fast Boot	-Disabled -Enabled	When enabled, system would omit several non-critical devices initialization in order to speed up boot up time.

<b>BIOS Setting</b>	<b>Options</b>	<b>Description/Purpose</b>
Launch PXE OpROM	-Disabled -Enabled	Enables or disables the boot option for legacy network devices.
Boot Option #1	-[USB/DVD/ hard drive(s)] -Built-in EFI shell -Disabled	Allows setting up boot option(s) from menu listed.
Hard Drive BBS Priorities	Sub-menu	Enters sub-menu to select from bootable hard drive/USB flash disks (if available).

### 4-6-1. Boot – Hard Drive BBD Priorities



**Hard drive BBD Priorities screen**

BIOS Setting	Options	Description/Purpose
Boot Option #1	-[drive(s)] -Disabled	Allows setting the boot order of available drive(s).

## 4-7. Security

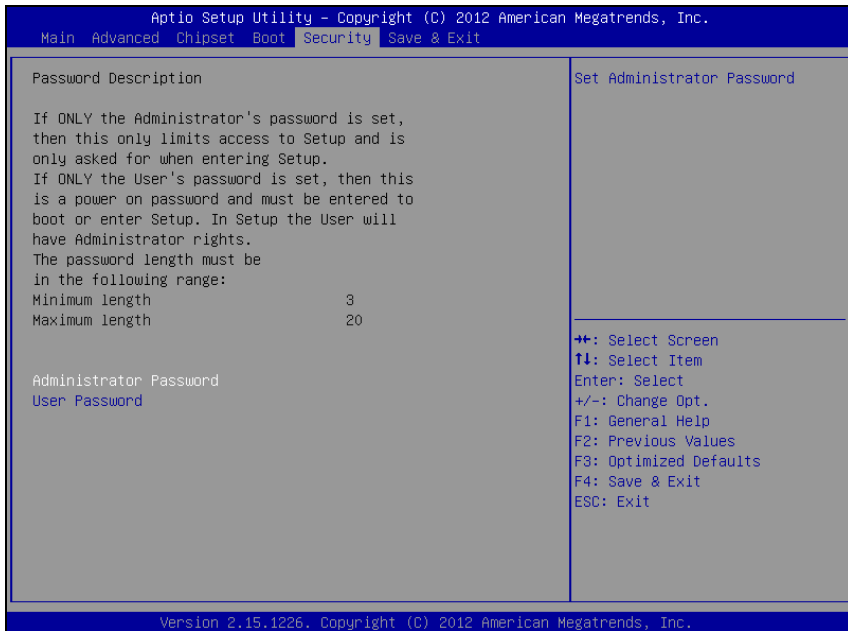

Security screen

BIOS Setting	Options	Description/Purpose
Administrator Password	Password can be up to 20 alphanumeric characters	Specifies the administrator password.
User Password	Password can be up to 20 alphanumeric characters	Specifies the user password.
HDD Security Configuration	Sub-menu	Enters sub-menu with option to enabled password protected HDD/SSD (if supported by SATA device).



## 4-8. Save & Exit

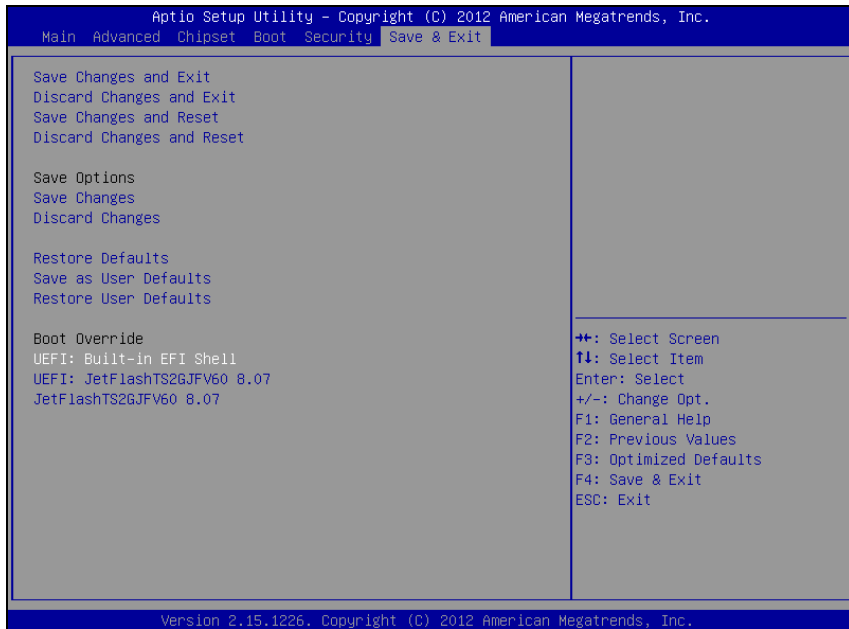

Save & Exit screen

BIOS Setting	Options	Description/Purpose
Save Changes and Exit	No changeable options	Exits and saves the changes in CMOS memory.
Discard Changes and Exit	No changeable options	Exits without saving any changes made in BIOS settings.
Save Changes and Reset	No changeable options	Saves the changes in CMOS memory and resets.
Discard Changes and Reset	No changeable options	Resets without saving any changes made in BIOS settings.
Save Changes	No changeable options	Saves the changes done in BIOS settings so far.
Discard Changes	No changeable options	Discards the changes done in BIOS settings so far.

<b>BIOS Setting</b>	<b>Options</b>	<b>Description/Purpose</b>
Restore Defaults	No changeable options	Loads the optimized defaults for BIOS settings.
Save as User Defaults	No changeable options	Saves the current values as user defaults.
Restore User Defaults	No changeable options	Loads the user defaults for BIOS settings.
Boot Override	-[drive(s)]	Forces to boot from selected [drive(s)] or UEFI shell

# ***SYSTEM ASSEMBLY***

*APPENDIX*

**A**

This appendix contains the exploded diagram of the system.

Section includes:

- Exploded Diagram for System with Capacitive Panel
  - Front Panel
  - Front Cover
  - Mainboard
  - Panel Holder
  - Rear Case
  
- Exploded Diagram for System with Resistive Panel
  - Front Panel
  - Front Cover
  - Mainboard
  - Panel Holder
  - Rear Case
  
- Exploded Diagram for HDD

**EXPLODED DIAGRAM FOR SYSTEM WITH CAPACITIVE  
PANEL**

**Front Panel**

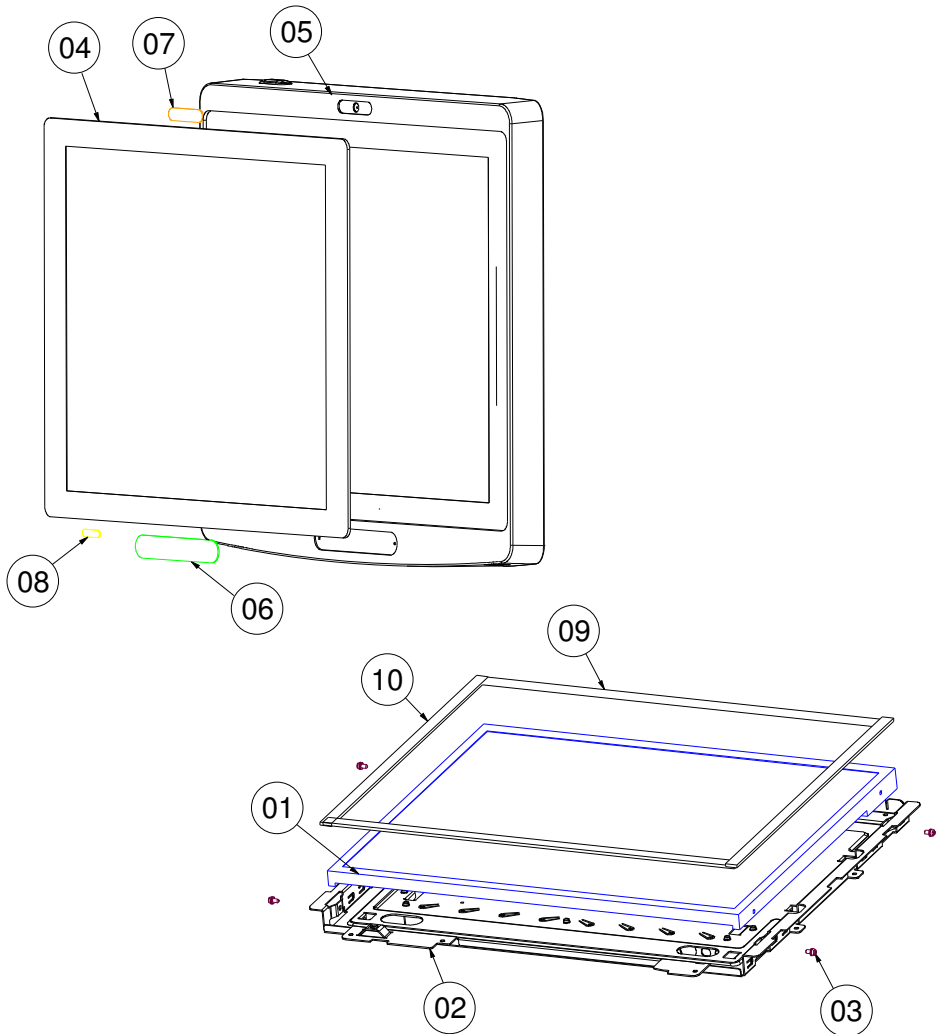

NO.	Component Name	Part No.	Q'ty
1	LCD_PANEL_AUO	52-351-04017002	1
2	LCD_HOLDER	80-029-03001295	1
3	M3_6_R_S	22-232-30060211	4
4	TOUCH_PANEL_17_MILDEX	52-380-04172317	1
5	P_FRONT_COVER	30-002-12120258	1
6	FUNCTION_KEY_LENS	30-021-02230258	1
7	WEB_CAM_LENS	30-021-02530258	1
8	POWER_LED_LENS	30-002-02230258	1
9	PORON_SPONGE_H	90-013-24200255	2
10	PORON_SPONGE_V	90-013-24100255	2

Front Cover

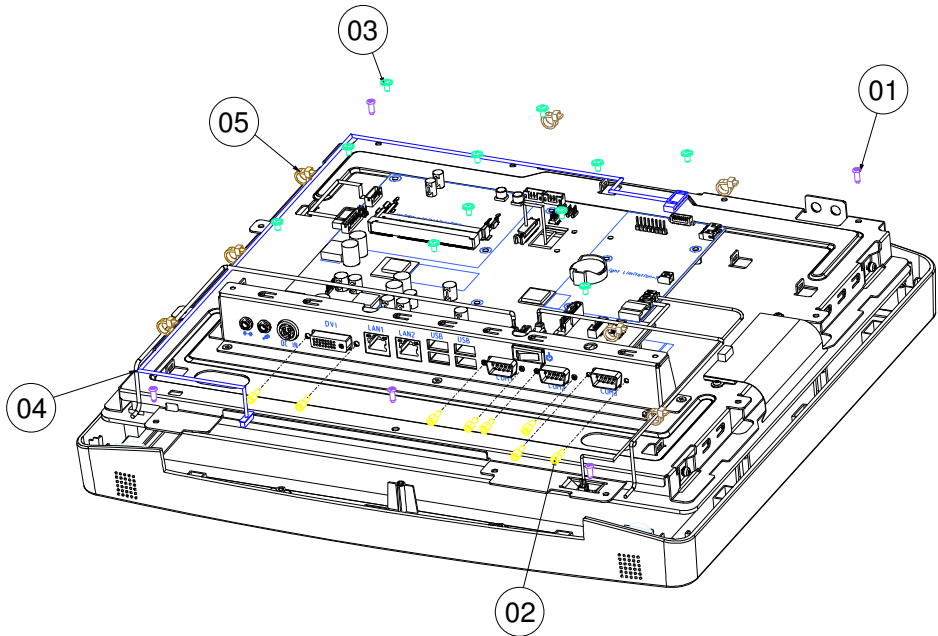

NO.	Component Name	Part No.	Q'ty
1	HEAD_T3_L8	22-122-30080011	5
2	BOSS_NO4_UNC_L5_H6_8	22-692-40048051	8
3	M3_5_WASHER	22-242-30005311	11
4	OSD_cable	27-058-29513111	1
5	CABLE_TIE	30-015-04200000	7

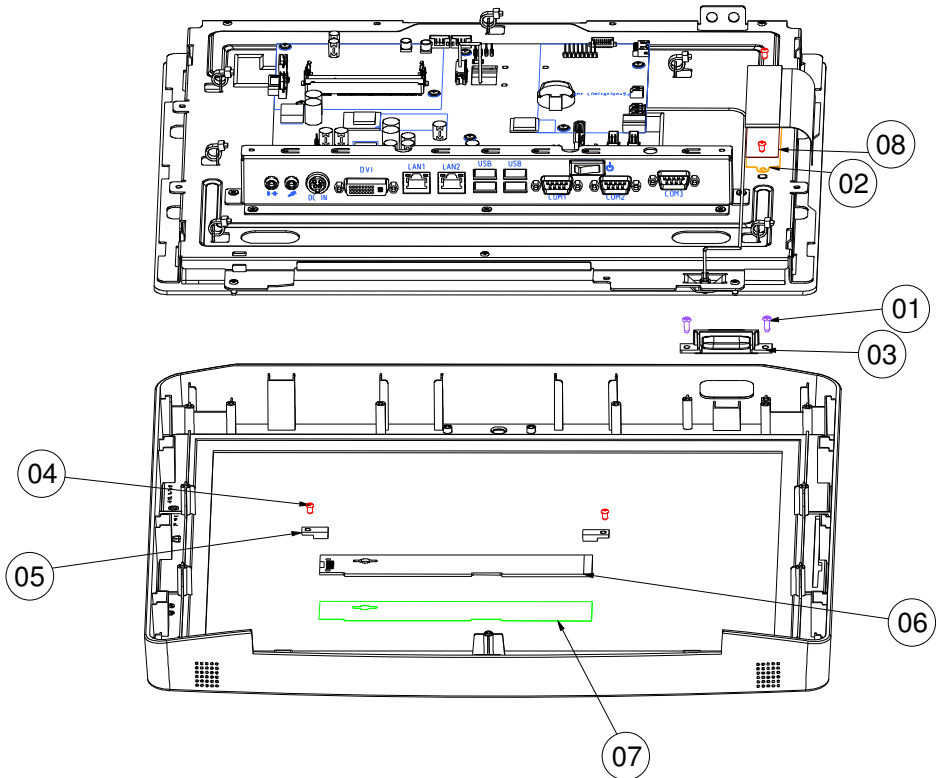

NO.	Component Name	Part No.	Q'ty
1	HEAD_T3_L8	22-122-30080011	2
2	TOUCH_BOARD_BRACKET	80-006-03001258	1
3	EM_LED_COVER	30-002-02130258	1
4	M3_L5	22-230-30005811	4
5	RUBBER FOOT	90-004-04100000	2
6	FUNCTION_KEY_PCB	MR-701XRA-11N	1
7	Double Faced Tape	94-026-04501258	1
8	Double Faced Adhesive Tape	94-026-04502258	1

Mainboard

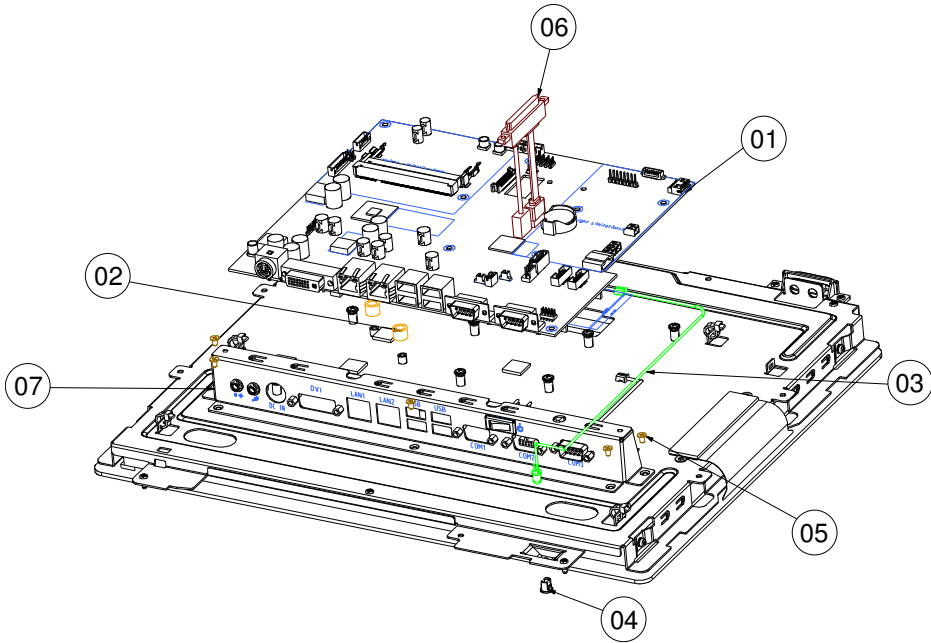

NO.	Component Name	Part No.	Q'ty
1	PCB	SB-6310R3-10N	1
2	SPACER_SUPPORT	30-041-04170000	2
3	POWER_LED_CABLE	27-018-29506071	1
4	LED_HOUSING	30-014-04100009	1
5	M3_5_FLAT	22-215-30005011	5
6	SATA_CABLE	27-008-29504081	1
7	IO PLATE	20-005-03101295	1



Panel Holder

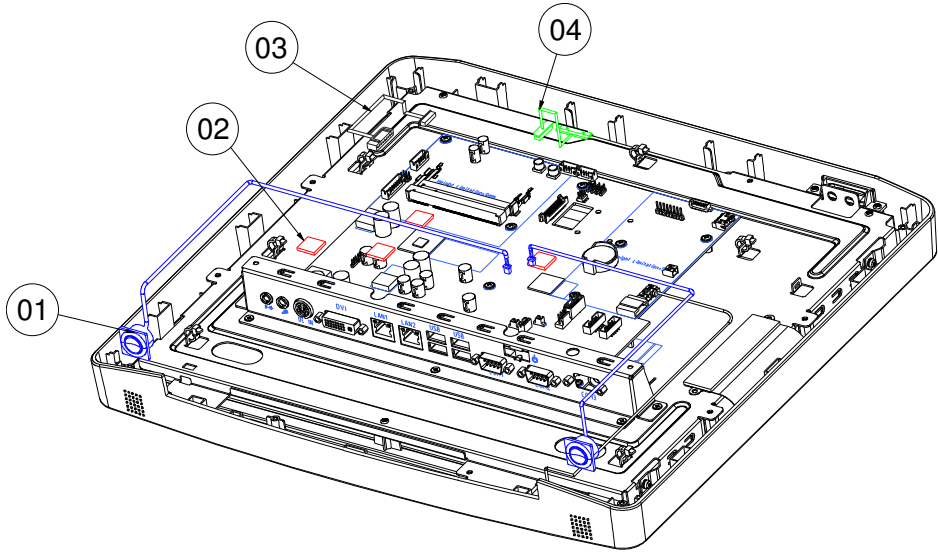

NO.	Component Name	Part No.	Q'ty
1	SPEAKER_CABLE	27-021-29507071	2
2	Thermal_Interface_Pads	81-006-81313002	4
3	PANEL_LED_CABLE	27-069-28004111	1
4	LVDS_CABLE	27-020-25802111	1

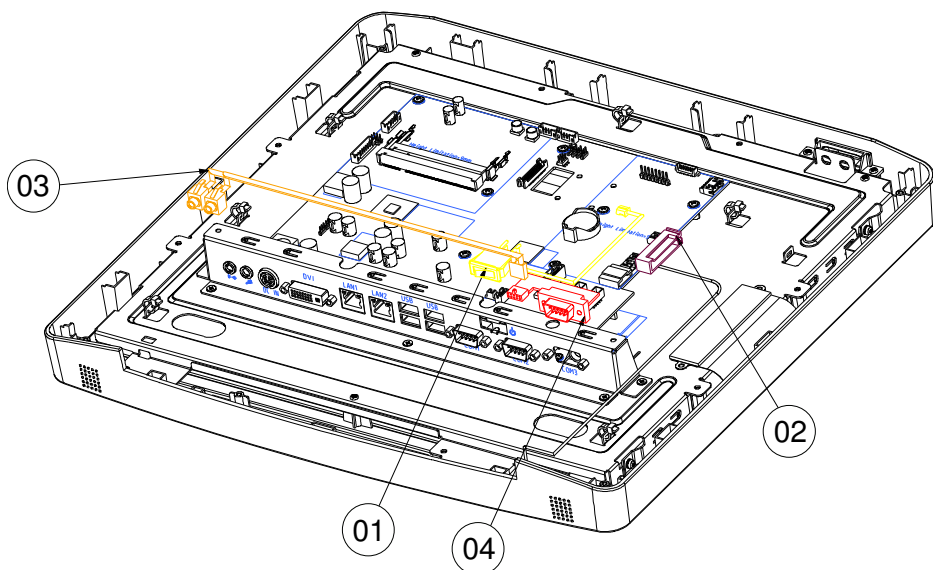

NO.	Component Name	Part No.	Q'ty
1	POWER_BUTTON_CABLE	27-019-25803071	1
2	FLAT_CABLE_CLAMP	30-042-04100258	1
3	PHONE_JACK_CABLE	27-028-29506111	1
4	COM_PORT_CABLE	27-024-00403031	1

Rear Case

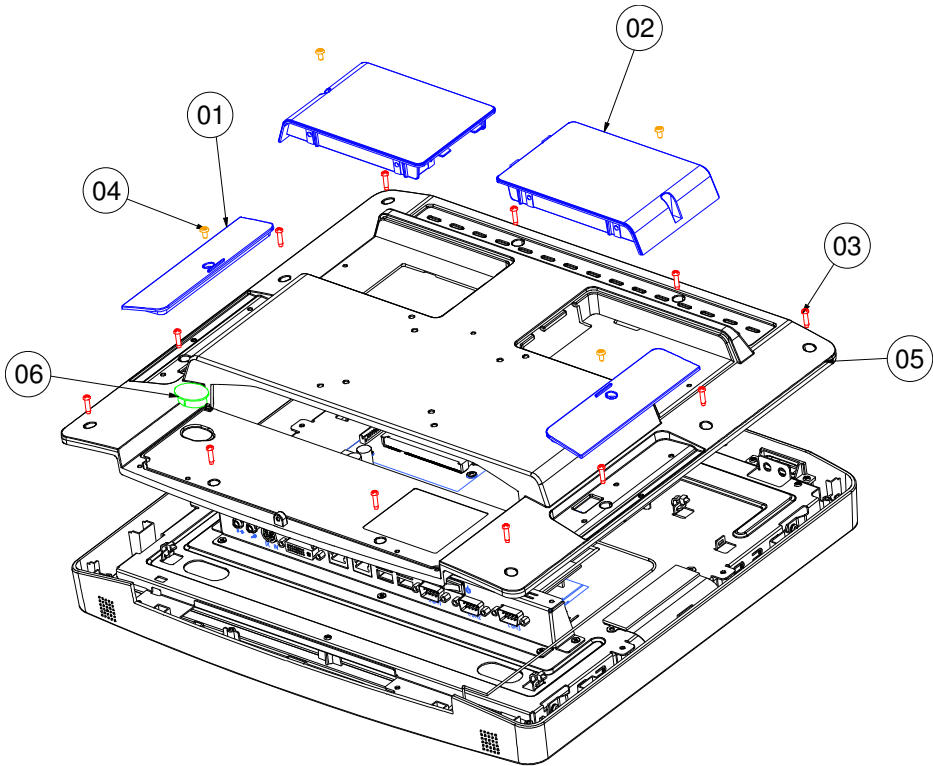

NO.	Component Name	Part No.	Q'ty
1	OPTION COVER	30-002-12220258	2
2	HDD COVER	20-004-01062295	2
3	T3_L12_TAPPING	22-125-30012061	12
4	M3_6_ROUND	22-272-30006311	4
5	BACK COVER	20-004-01061295	1
6	HOLE PLUG	90-067-04200000	1

**EXPLODED DIAGRAM FOR SYSTEM WITH RESISTIVE  
PANEL**

**Front Panel**

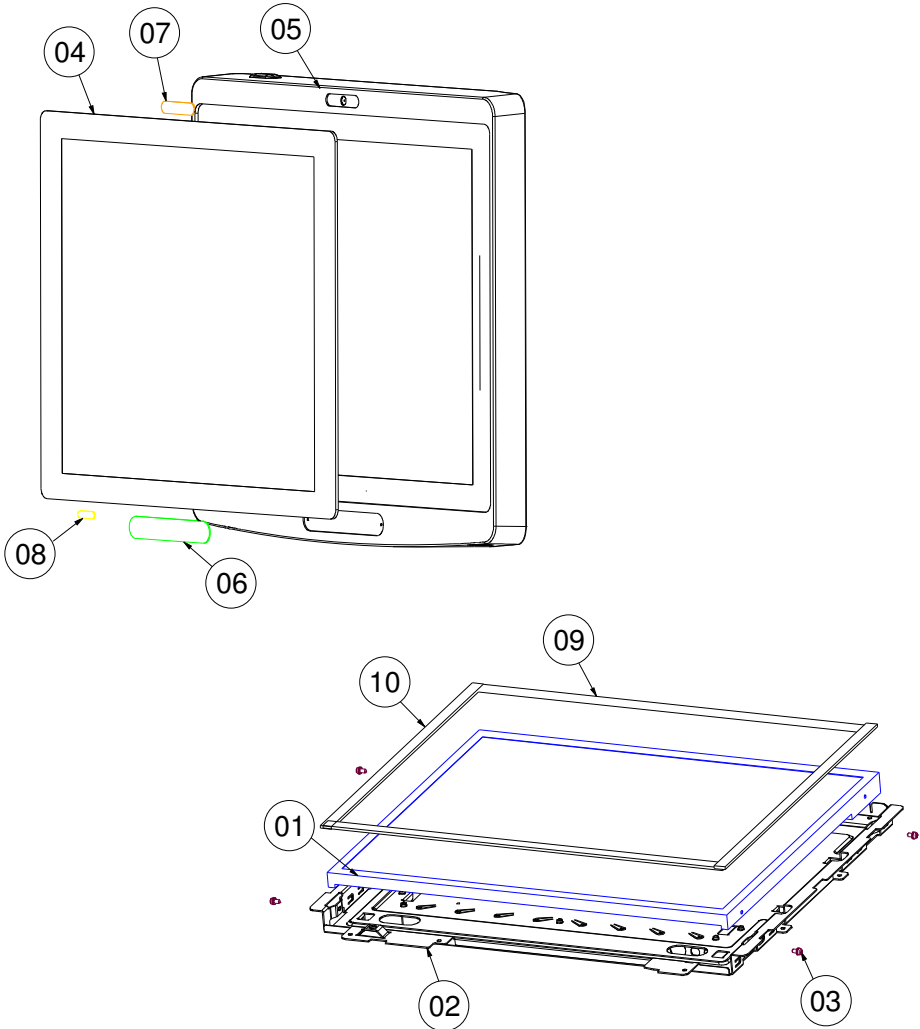

NO.	Component Name	Part No.	Q'ty
1	LCD_PANEL_AUO	52-351-04017002	1
2	LCD_HOLDER	80-029-03001295	1
3	M3_6_R_S	22-232-30060211	4
4	TOUCH_PANEL_17_MILDEX	52-380-04151017	1
5	P_FRONT_COVER	30-002-12120258	1
6	FUNCTION_KEY_LENS	30-021-02230258	1
7	WEB_CAM_LENS	30-021-02530258	1
8	POWER_LED_LENS	30-002-02230258	1
9	PORON_SPONGE_H	90-013-24200255	2
10	PORON_SPONGE_V	90-013-24100255	2

Front Cover

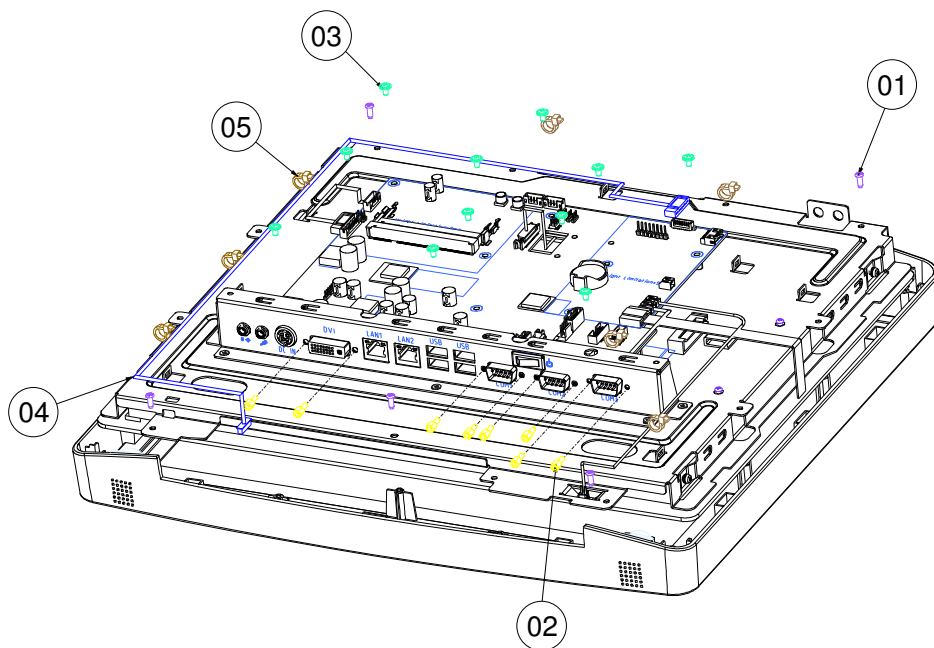

NO.	Component Name	Part No.	Q'ty
1	HEAD_T3_L8	22-122-30080011	5
2	BOSS_NO4_UNC_L5_H6_8	22-692-40048051	8
3	M3_5_WASHER	22-242-30005311	11
4	OSD_cable	27-058-29513111	1
5	CABLE_TIE	30-015-04200000	7

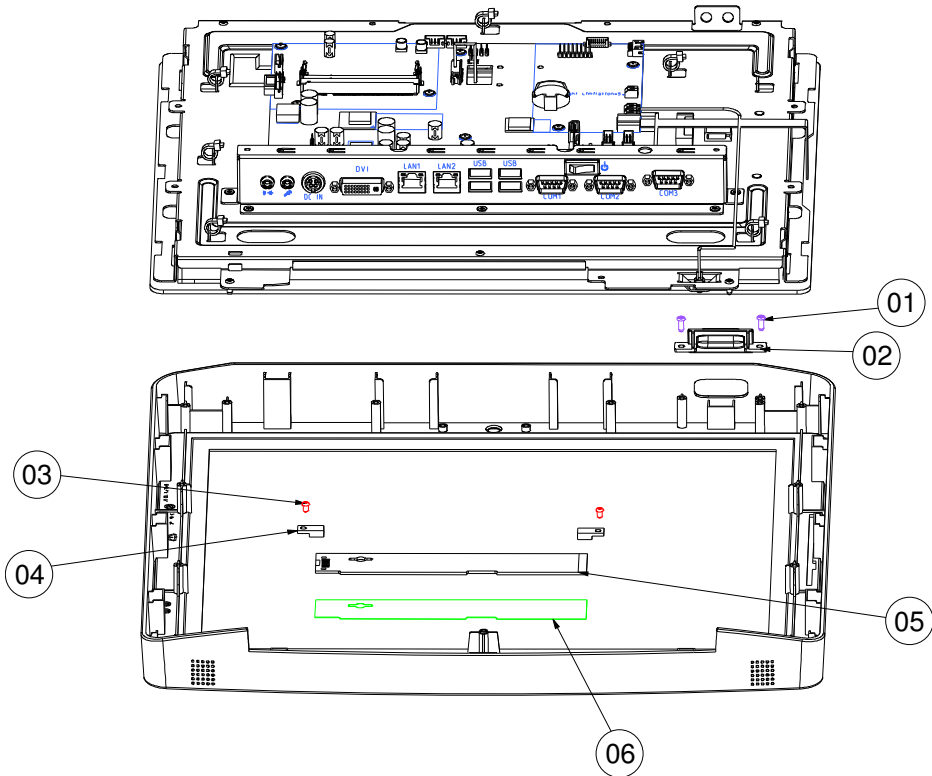

NO.	Component Name	Part No.	Q'ty
1	HEAD_T3_L8	22-122-30080011	2
2	EM_LED_COVER	30-002-02130258	1
3	M3_L5	22-230-30005811	2
4	RUBBER FOOT	90-004-04100000	2
5	FUNCTION_KEY_PCB	MR-701XRA-11N	1
6	Double Faced Tape	94-026-04501258	1

Mainboard

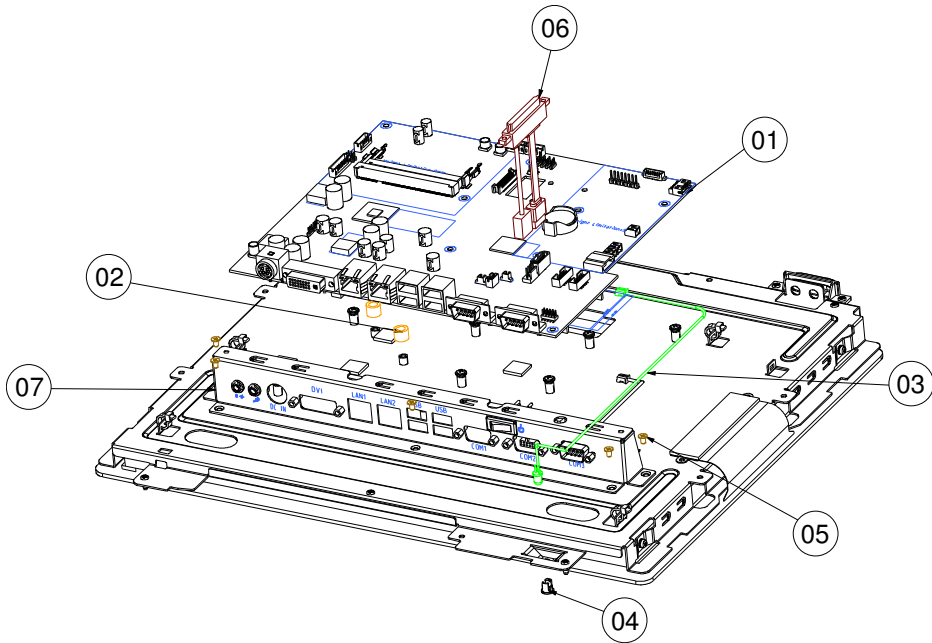

NO.	Component Name	Part No.	Q'ty
1	PCB	SB-6310R3-10N	1
2	SPACER_SUPPORT	30-041-04170000	2
3	POWER_LED_CABLE	27-018-29506071	1
4	LED_HOUSING	30-014-04100009	1
5	M3.5_FLAT	22-215-30005011	5
6	SATA_CABLE	27-008-29504081	1
7	IO_PLATE	20-005-03101295	1



Panel Holder

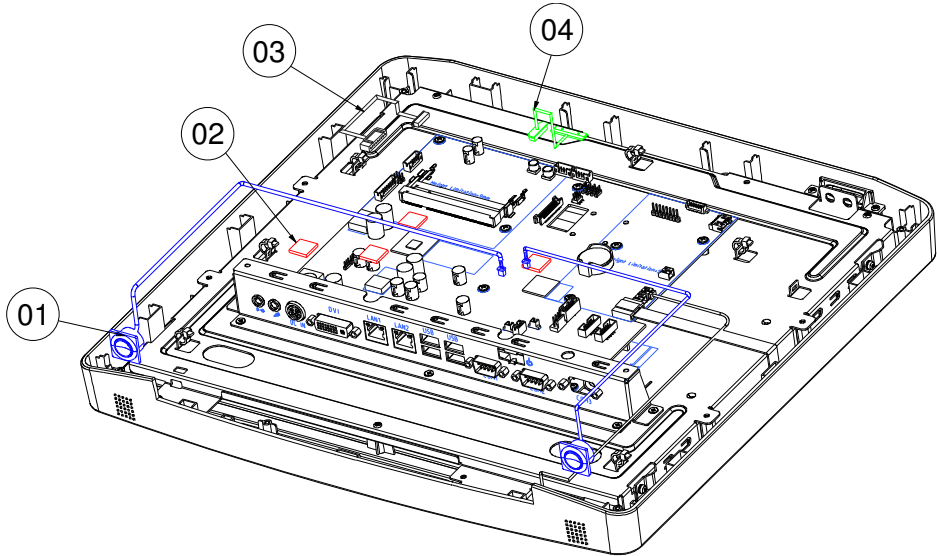

NO.	Component Name	Part No.	Qty
1	SPEAKER_CABLE	27-021-29507071	2
2	Thermal_Interface_Pads	81-006-81313002	4
3	PANEL_LED_CABLE	27-069-28004111	1
4	LVDS_CABLE	27-020-25802111	1

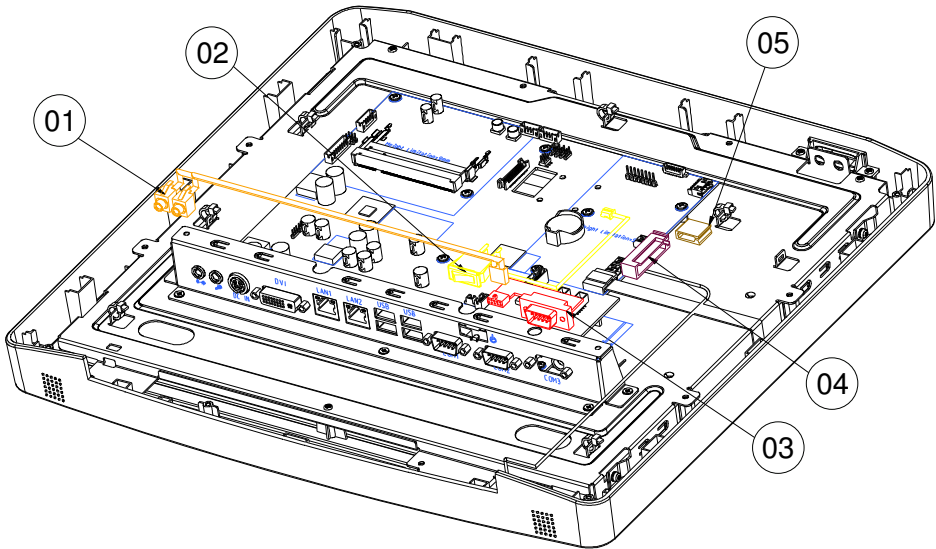

NO.	Component Name	Part No.	Qty
1	PHONE_JACK_CABLE	27-028-29506111	1
2	POWER_BUTTON_CABLE	27-019-25803071	1
3	COM_PORT_CABLE	27-024-00403031	1
4	FLAT_CABLE_CLAMP	30-042-04100258	1
5	WIRE MOUNT	30-023-04100000	1

Rear Case

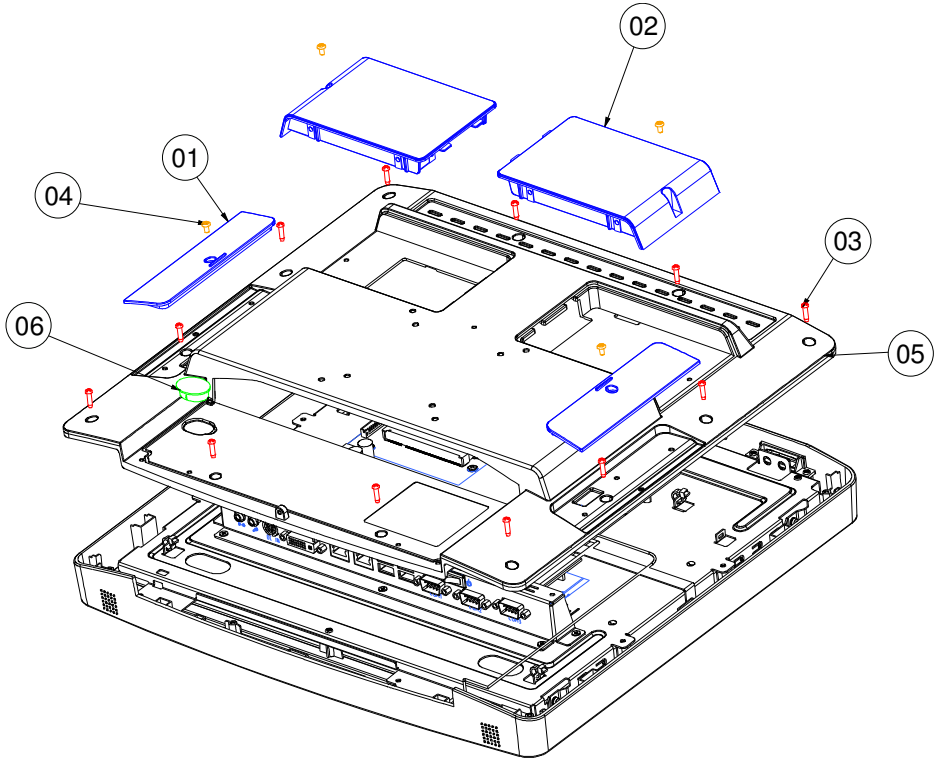

NO.	Component Name	Part No.	Q'ty
1	OPTION COVER	30-002-12220258	2
2	HDD COVER	20-004-01062295	2
3	T3_L12_TAPPING	22-125-30012061	12
4	M3_6_ROUND	22-272-30006311	4
5	BACK COVER	20-004-01061295	1
6	HOLE PLUG	90-067-04200000	1

**EXPLODED DIAGRAM FOR HDD**

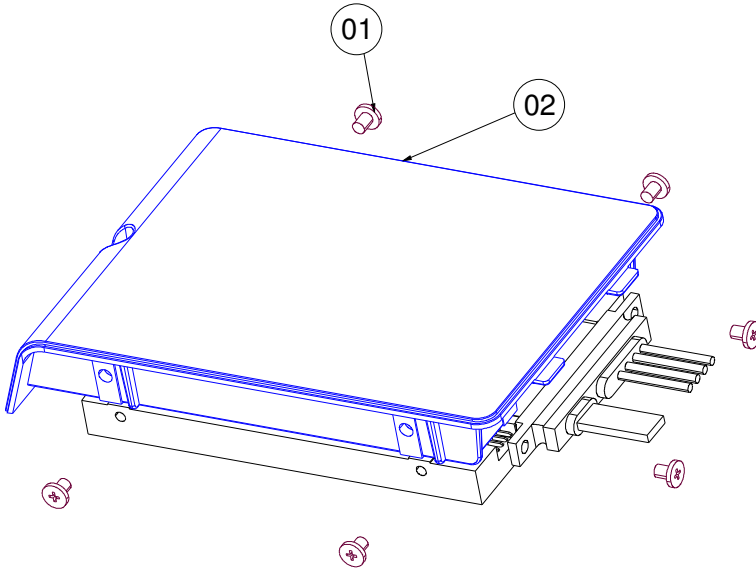

NO.	Component Name	Part No.	Q'ty
1	M3_L5	22-230-30005811	6
2	HDD_COVER	--	1

# ***TECHNICAL SUMMARY***

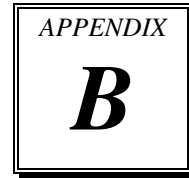

This section introduces you the maps concisely.

Section includes:

- Block Diagram
- Interrupt Map
- DMA Channels Map
- I/O Map
- Watchdog Timer Configuration
- Flash BIOS Update

**BLOCK DIAGRAM**

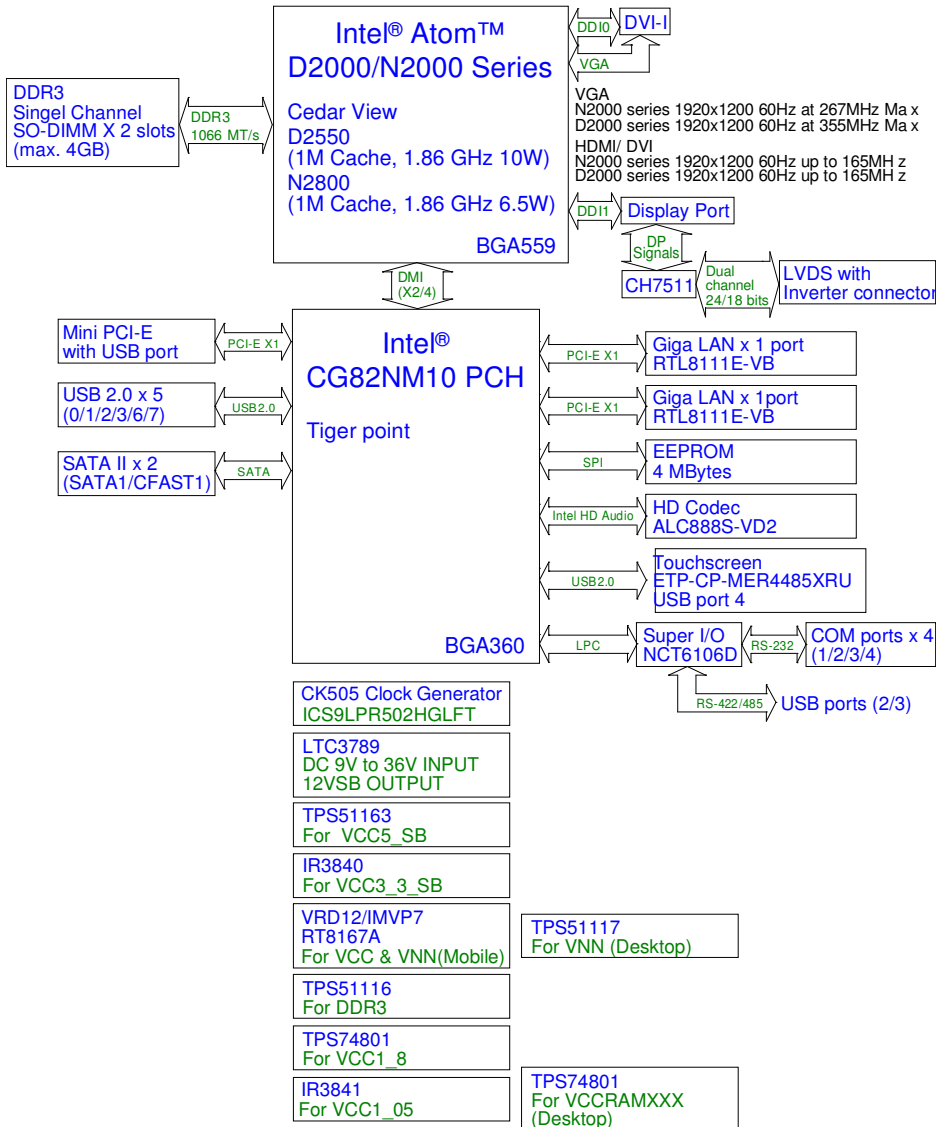

## INTERRUPT MAP

IRQ	ASSIGNMENT
4	Communications Port (COM1)
3	Communications Port (COM2)
6	Communications Port (COM3)
19	Standard AHCI 1.0 Serial ATA Controller
19	Intel® N10/ICH7 Family USB Universal Host Controller - 27C9
18	Intel® N10/ICH7 Family PCI Express Root Port - 27D4
18	Intel® N10/ICH7 Family USB Universal Host Controller - 27CA
7	Communications Port (COM4)
10	Communications Port (COM5)
-	Realtek PCIe GBE Family Controller #3
23	Intel® N10/ICH7 Family USB Universal Host Controller - 27C8
23	Intel® N10/ICH7 Family USB2 Enhanced Host Controller - 27CC
12	Microsoft PS/2 Mouse
0	System timer
22	High Definition Audio Controller
8	System CMOS/real time clock
81 - 190	Microsoft ACPI-Compliant System
16	Intel® N10/ICH7 Family USB Universal Host Controller - 27CB
16	Intel® N10/ICH7 Family PCI Express Root Port - 27D0
1	Standard PS/2 Keyboard
11	Intel® N10/ICH7 Family SMBus Controller - 27DA
-	Intel® Graphics Media Accelerator 3600 Series
13	Numeric data processor

## **DMA CHANNELS MAP**

<b>TIMER CHANNEL</b>	<b>ASSIGNMENT</b>
Channel 4	Direct memory access controller



## I/O MAP

I/O MAP	ASSIGNMENT
0x00000378-0x0000037F	Printer Port (LPT1)
0x000003F8-0x000003FF	Communications Port (COM1)
0x000002F8-0x000002FF	Communications Port (COM2)
0x000003E8-0x000003EF	Communications Port (COM3)
0x0000F0F0-0x0000F0F7	Standard AHCI 1.0 Serial ATA Controller
0x0000F0E0-0x0000F0E3	Standard AHCI 1.0 Serial ATA Controller
0x0000F0D0-0x0000F0D7	Standard AHCI 1.0 Serial ATA Controller
0x0000F0C0-0x0000F0C3	Standard AHCI 1.0 Serial ATA Controller
0x0000F020-0x0000F02F	Standard AHCI 1.0 Serial ATA Controller
0x0000E000-0x0000EFFF	Intel® N10/ICH7 Family PCI Express Root Port - 27D4
0x0000E000-0x0000EFFF	Realtek PCIe GBE Family Controller #3
0x000002E8-0x000002EF	Communications Port (COM4)
0x00000020-0x00000021	Programmable interrupt controller
0x00000024-0x00000025	Programmable interrupt controller
0x00000028-0x00000029	Programmable interrupt controller
0x0000002C-0x0000002D	Programmable interrupt controller
0x00000030-0x00000031	Programmable interrupt controller
0x00000034-0x00000035	Programmable interrupt controller
0x00000038-0x00000039	Programmable interrupt controller
0x0000003C-0x0000003D	Programmable interrupt controller
0x000000A0-0x000000A1	Programmable interrupt controller
0x000000A4-0x000000A5	Programmable interrupt controller
0x000000A8-0x000000A9	Programmable interrupt controller
0x000000AC-0x000000AD	Programmable interrupt controller
0x000000B0-0x000000B1	Programmable interrupt controller
0x000000B4-0x000000B5	Programmable interrupt controller
0x000000B8-0x000000B9	Programmable interrupt controller
0x000000BC-0x000000BD	Programmable interrupt controller
0x000004D0-0x000004D1	Programmable interrupt controller

<b>I/O MAP</b>	<b>ASSIGNMENT</b>
0x000004D0-0x000004D1	Motherboard resources
0x000002E0-0x000002E7	Communications Port (COM5)
0x0000F0A0-0x0000F0BF	Intel® N10/ICH7 Family USB Universal Host Controller - 27C8
0x00000000-0x00000CF7	PCI bus
0x00000000-0x00000CF7	Direct memory access controller
0x00000D00-0x0000FFFF	PCI bus
0x00000040-0x00000043	System timer
0x00000050-0x00000053	System timer
0x0000F080-0x0000F09F	Intel® N10/ICH7 Family USB Universal Host Controller - 27C9
0x00000070-0x00000077	System CMOS/real time clock
0x00000070-0x00000077	Motherboard resources
0x0000F060-0x0000F07F	Intel® N10/ICH7 Family USB Universal Host Controller - 27CA
0x0000F040-0x0000F05F	Intel® N10/ICH7 Family USB Universal Host Controller - 27CB
0x00000081-0x00000091	Direct memory access controller
0x00000093-0x0000009F	Direct memory access controller
0x000000C0-0x000000DF	Direct memory access controller
0x00000010-0x0000001F	Motherboard resources
0x00000022-0x0000003F	Motherboard resources
0x00000044-0x0000005F	Motherboard resources
0x00000062-0x00000063	Motherboard resources
0x00000065-0x0000006F	Motherboard resources
0x00000065-0x0000006F	Motherboard resources
0x00000072-0x0000007F	Motherboard resources
0x00000080-0x00000080	Motherboard resources
0x00000080-0x00000080	Motherboard resources
0x00000084-0x00000086	Motherboard resources
0x00000088-0x00000088	Motherboard resources
0x0000008C-0x0000008E	Motherboard resources

<b>I/O MAP</b>	<b>ASSIGNMENT</b>
0x00000090-0x0000009F	Motherboard resources
0x000000A2-0x000000BF	Motherboard resources
0x000000E0-0x000000EF	Motherboard resources
0x00000290-0x0000029F	Motherboard resources
0x000002A0-0x000002AF	Motherboard resources
0x0000002E-0x0000002F	Motherboard resources
0x0000004E-0x0000004F	Motherboard resources
0x00000061-0x00000061	Motherboard resources
0x00000063-0x00000063	Motherboard resources
0x00000067-0x00000067	Motherboard resources
0x00000092-0x00000092	Motherboard resources
0x000000B2-0x000000B3	Motherboard resources
0x00000680-0x0000069F	Motherboard resources
0x00001000-0x0000100F	Motherboard resources
0x0000FFFF-0x0000FFFF	Motherboard resources
0x0000FFFF-0x0000FFFF	Motherboard resources
0x00000400-0x0000047F	Motherboard resources
0x00000400-0x0000047F	Motherboard resources
0x00000500-0x0000057F	Motherboard resources
0x00000500-0x0000057F	Motherboard resources
0x00000600-0x0000061F	Motherboard resources
0x00000060-0x00000060	Standard PS/2 Keyboard
0x00000064-0x00000064	Standard PS/2 Keyboard
0x000006A0-0x000006AF	Motherboard resources
0x000006B0-0x000006EF	Motherboard resources
0x0000F000-0x0000F01F	Intel® N10/ICH7 Family SMBus Controller - 27DA
0x0000F100-0x0000F107	Intel® Graphics Media Accelerator 3600 Series
0x000003B0-0x000003BB	Intel® Graphics Media Accelerator 3600 Series
0x000003C0-0x000003DF	Intel® Graphics Media Accelerator 3600 Series
0x000000F0-0x000000F0	Numeric data processor

## **WATCHDOG TIMER CONFIGURATION**

The I/O port address of the watchdog timer is 2E (hex) and 2F (hex). 2E (hex) is the address port. 2F (hex) is the data port. User must first assign the address of register by writing address value into address port 2E (hex), then write/read data to/from the assigned register through data port 2F (hex).

### **Configuration Sequence**

To program [NCT6106D](#) configuration registers, the following configuration sequence must be followed:

- (1) Enter the extended function mode
- (2) Configure the configuration registers
- (3) Exit the extended function mode

#### **(1) Enter the extended function mode**

To place the chip into the Extended Function Mode, two successive writes of 0x87 must be applied to Extended Function Enable Registers (EFERs, i.e. 2Eh or 4Eh).

#### **(2) Configure the configuration registers**

The chip selects the Logical Device and activates the desired Logical Devices through Extended Function Index Register (EFIR) and Extended Function Data Register (EFDR). The EFIR is located at the same address as the EFER, and the EFDR is located at address (EFIR+1). First, write the Logical Device Number (i.e. 0x07) to the EFIR and then write the number of the desired Logical Device to the EFDR. If accessing the Chip (Global) Control Registers, this step is not required. Secondly, write the address of the desired configuration register within the Logical Device to the EFIR and then write (or read) the desired configuration register through the EFDR.

#### **(3) Exit the extended function mode**

To exit the Extended Function Mode, writing 0xAA to the EFER is required. Once the chip exits the Extended Function Mode, it is in the normal running mode and is ready to enter the configuration mode.

## Code example for watchdog timer

Enable and start watchdog timer, then set 30 seconds as the timeout interval.

```
----- Enter to extended function mode -----  
Mov  dx,    2eh  
Mov  al,    87h  
Out  dx,    al  
Out  dx,    al  
----- Select Logical Device 8 of watchdog timer -----  
Mov  al,    07h  
Out  dx,    al  
Inc  dx  
Mov  al,    08h  
Out  dx,    al  
----- Set second as counting unit -----  
Dec  dx  
Mov  al,    0f5h  
Out  dx,    al  
Inc  dx  
In   al,    dx  
And  al,    not 08h  
Out  dx,    al  
----- Set timeout interval as 30seconds and start counting -----  
Dec  dx  
Mov  al,    0f6h  
Out  dx,    al  
Inc  dx  
Mov  al,    30  
Out  dx,    al  
----- Exit the extended function mode -----  
Dec  dx  
Mov  al,    0aah  
Out  dx,    al
```

## FLASH BIOS UPDATE

### I. Before system BIOS update

1. Prepare a bootable media (e.g. USB storage device) which can boot system to DOS prompt.
2. Download and save the BIOS file (e.g. [71170P0x.rom](#)) to the bootable device.
3. Copy AMI flash utility – AFUDOS.exe (V3.04.03) into the bootable device

```
C:\AFUDOS>dir

Volume in drive C is EFI_DUET
Volume Serial Number is 32E4-9D1F
Directory of C:\AFUDOS

                <DIR>                02-23-12    9.51a
                <DIR>                02-23-12    9.51a
AFUDOS          EXE             167,152    11-12-12    3.12p
63100P01       BIN             4,194,304  10-02-13    2.14p
                2 file(s)                4,361,456 bytes
                2 dir(s)                864,940,088 bytes free

C:\AFUDOS>
```

4. Make sure the target system can first boot to the bootable device.
  - a. Connect the bootable USB device.
  - b. Turn on the computer and press <Del> or <F2l> key during boot to enter BIOS setup menu.
  - c. System will go into the BIOS setup menu.
  - d. Select [Boot] menu as the picture shows below.
  - e. Select [Hard Drive BBS Priorities], set the USB bootable device as the 1<sup>st</sup> boot device.

- f. Press <F4> key to save configuration and exit the BIOS setup menu.

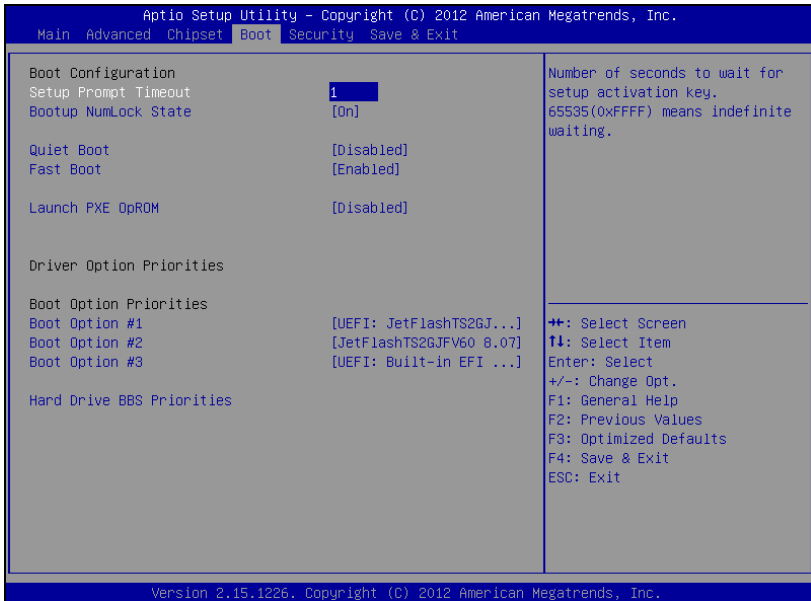

## **II. AFUDOS command for system BIOS update**

AFUDOS.exe is aforementioned AMI firmware update utility; the command line is shown as below:

`AFUDOS <ROM File Name> [option1] [option2]...`

You can type `AFUDOS /?` to see all the definition of each control options. The recommended options for BIOS ROM update consist of following parameters:

`/P`: program main BIOS image

`/B`: program Boot Block

`/N`: program NVRAM

`/X`: don't check ROM ID



### III. BIOS update procedure

1. Use the bootable USB device to boot up system into the MS-DOS command prompt
2. Type in `AFUDOS 711700P0x.rom /p /b /n /x` and press enter to start the flash procedure

**Note:** `xxxx` means the BIOS revision part, ex. 0Px1...

3. During the update procedure, you will see the BIOS update process status and its percentage. **Beware!** Do not turn off or reset your computer before the update is complete, or it may crash the BIOS ROM and make the system unable to boot up next time. The whole update process may take up to 3 minutes.

```
C:\afudos 71170P01.rom /b /p /n /x

+-----+
|           AMI Firmware Update Utility           v3.04.03           |
|   Copyright (C) 2012 American Megatrends Inc. All Rights Reserved. |
+-----+

Reading file ..... done
- FFS checksums ..... ok
Erasing Boot Block ..... done
Updating Boot Block ..... done
Verifying Boot Block .... done
Erasing Main Block ..... done
Updating Main Block ..... 0x0006E600 (8%)
```

4. After the BIOS update is complete, the messages from AFUDOS utility should be like the figure shown below.

```
C:\afudos 71170P01.rom /b /p /n /x

+-----+
|           AMI Firmware Update Utility           v3.04.03           |
|   Copyright (C) 2012 American Megatrends Inc. All Rights Reserved. |
+-----+

Reading file ..... done
- FFS checksums ..... ok
Erasing Boot Block ..... done
Updating Boot Block ..... done
Verifying Boot Block .... done
Erasing Main Block ..... done
Updating Main Block ..... done
Verifying Main Block .... done
Erasing NVRAM Block ..... done
Updating NVRAM Block .... done
Verifying NVERAM Block .. done

C:\AFUDOS>
```

5. You can restart the system and boot up with new BIOS now
6. Update is complete after restart
7. Verify during the following boot that BIOS version displayed at the initialization screen has changed.

