

USER'S MANUAL

**SP-6205/6207/
SP-6208/6209**

**Intel® 3rd Gen. Core™ i3/i5/i7 CPU
15"/17"/18.5"/19" High Performance &
Fanless Panel PC With VGA/DIO/2LAN**

SP-6205/6207/6208/6209 M4

SP-6205,6207,6208,6209
Intel[®] Core[™] 3rd Gen. Mobile
i3/i5/i7 High Performance
15"/17"/18.5"/19" Fanless Embedded PC

COPYRIGHT NOTICE & TRADEMARK

All trademarks and registered trademarks mentioned herein are the property of their respective owners.

This manual is copyrighted in Nov. 2016. You may not reproduce or transmit in any form or by any means, electronic, or mechanical, including photocopying and recording.

DISCLAIMER

This user's manual is meant to assist you in installing and setting up the system. The information contained in this document is subject to change without any notice.

CE NOTICE

This is a class A product. In a domestic environment this product may cause radio interference in which case the user may be required to take adequate measures.

FCC NOTICE

This equipment has been tested and found to comply with the limits for a Class A digital device, pursuant to part 15 of the FCC Rules. These limits are designed to provide reasonable protection against harmful interference when the equipment is operated in a commercial environment. This equipment generates, uses, and can radiate radio frequency energy and, if not installed and used in accordance with the instruction manual, may cause harmful interference to radio communications. Operation of this equipment in a residential area is likely to cause harmful interference in which case the user will be required to correct the interference at his own expense.

You are cautioned that any change or modifications to the equipment not expressly approve by the party responsible for compliance could void your authority to operate such equipment.

CAUTION! Danger of explosion if battery is incorrectly replaced. Replace only with the same or equivalent type recommended by the manufacturer. Dispose of used batteries according to the manufacturer's instructions.

WARNING! Some internal parts of the system may have high electrical voltage. And therefore we strongly recommend that qualified engineers can open and disassemble the system. The LCD and touch screen are easily breakable, please handle them with extra care.

TABLE OF CONTENTS

CHAPTER 1 INTRODUCTION

1-1	About This Manual.....	1-2
1-2	System Illustration.....	1-3
1-3	System Specifications.....	1-11
1-4	Safety Precautions.....	1-13

CHAPTER 2 SYSTEM CONFIGURATION

2-1	Jumper & Connector Quick Reference Table.....	2-2
2-2	Component Locations.....	2-3
2-3	How to Set Jumpers.....	2-5
2-4	Clear CMOS Data Selection.....	2-7
2-5	CFast Voltage Selection.....	2-7
2-6	COMPorts & Connectors.....	2-8
2-7	COM Ports RI & Voltage Selection.....	2-9
2-8	COM2 RS232/422/485 Selection.....	2-10
2-9	COM2 Auto Detect Selection.....	2-11
2-10	DIO Connector.....	2-12
2-11	Flash Descriptor Override Selection.....	2-13
2-12	Front Panel Connector & Selection.....	2-14
2-13	Internal Keyboard & Mouse Connectors.....	2-15
2-14	Hardware Power Failure Selection.....	2-15
2-15	JUSB Port Connector.....	2-16
2-16	LAN Connector.....	2-16
2-17	Printer Port.....	2-17
2-18	LVDS Connector.....	2-18
2-19	LVDS Inverter Connector.....	2-18
2-20	LVDS Panel Brightness Control Selection.....	2-19
2-21	LVDS Voltage Selection.....	2-19
2-22	Power Input Connector.....	2-20
2-23	SATA & SATA Power Connectors.....	2-21

2-24	Audio Connector.....	2-22
2-25	System Fan Connector	2-23
2-26	USB 3.0 Connector.....	2-23
2-27	VGA Connector.....	2-24
2-28	SIM Card Slot.....	2-24

CHAPTER 3 SOFTWARE UTILITIES

3-1	Introduction.....	3-2
3-2	Intel® Chipset Software Installation Utility.....	3-3
3-3	Intel® USB3.0 eXtensible Host Controller Utility.....	3-4
3-4	Intel® Management Engine Components Utility.....	3-5
3-5	VGA Driver Utility.....	3-6
3-6	LAN Driver Utility.....	3-7
3-7	Sound Driver Utility.....	3-8
3-8	Touchscreen Driver Utility.....	3-9

CHAPTER 4 AMI BIOS SETUP

4-1	Introduction.....	4-2
4-2	Entering Setup.....	4-4
4-3	Main.....	4-6
4-4	Advanced.....	4-7
4-5	Chipset.....	4-28
4-6	Boot.....	4-36
4-7	Security.....	4-37
4-8	Save & Exit.....	4-38

APPENDIX A SYSTEM DIAGRAMS

Exploded Diagram for Basic Construction.....	A-2
Exploded Diagram for Front Panel.....	A-4
Exploded Diagram for Mainboard.....	A-12
Exploded Diagram for Heatsink Cover.....	A-16
Exploded Diagram for HDD.....	A-20

APPENDIX B TECHNICAL SUMMARY

Block Diagram.....	B-2
Interrupt Map.....	B-3
DMA Channels Map.....	B-8
I/O Map.....	B-9
Watchdog Timer Configuration.....	B-13
Flash BIOS Update.....	B-15



INTRODUCTION

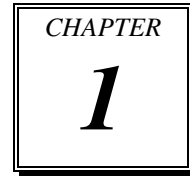

This chapter gives you the information for SP-6205/6207/6208/6209. It also outlines the System specification.

Section includes:

- About This Manual
- System Specifications
- Safety Precautions

Experienced users can skip to chapter 2 on page 2-1 for Quick Start.

1-1. ABOUT THIS MANUAL

Thank you for purchasing our SP-6205/6207/6208/6209 Intel® Core™ 3rd Gen. i3/i5/i7 CPU, 15"/17"/18.5"/19" fanless panel PC with VGA/DIO/2LAN. SP-6205/6207/6208/6209 provides faster processing speed, greater expandability and can handle more task than before. This manual is designed to assist you how to install and set up the system. It contains four chapters. The user can apply this manual for configuration according to the following chapters:

Chapter 1 Introduction

This chapter introduces you to the background of this manual, and the specifications for this system. The final page of this chapter will indicate how to avoid damaging this board.

Chapter 2 Hardware Configuration

This chapter outlines the component locations and their functions. In the end of this chapter, you will learn how to set jumper and how to configure this card to meet your own needs.

Chapter 3 Software Utilities

This chapter contains helpful information for proper installations of the VGA utility, LAN utility, and Sound utility.

Chapter 4 BIOS Setup

This chapter indicates you how to set up the BIOS configurations.

Appendix A System Diagrams

This appendix gives you the exploded diagrams and part numbers of the SP-6205/6207/6208/6209.

Appendix B Technical Summary

This appendix gives you the information about the Technical maps, Watchdog-timer configuration, and Flash BIOS Update.

1-2. SYSTEM ILLUSTRATION

SP-6205

Front View

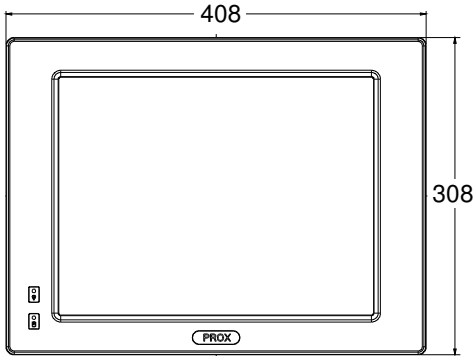

Rear View

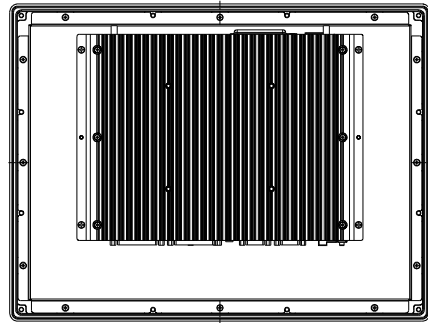

Top View

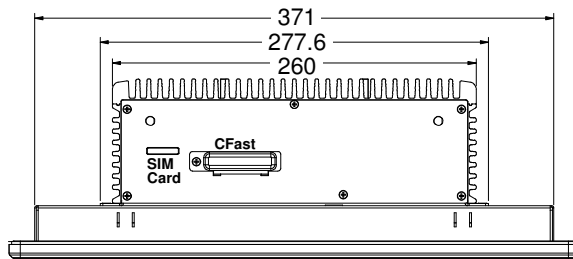

Bottom View

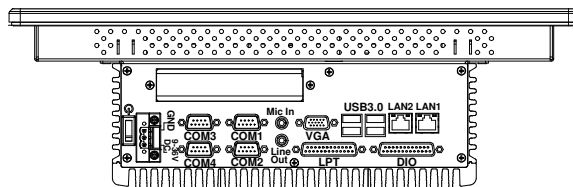

Unit: mm

Side View

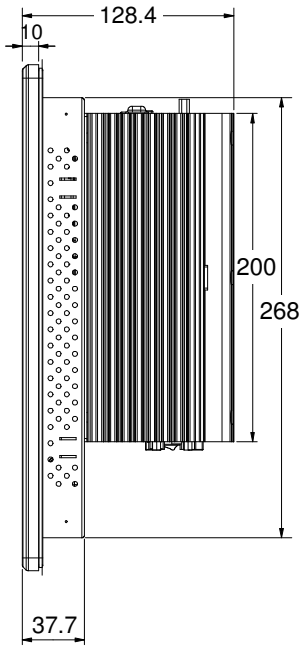

Quarter View

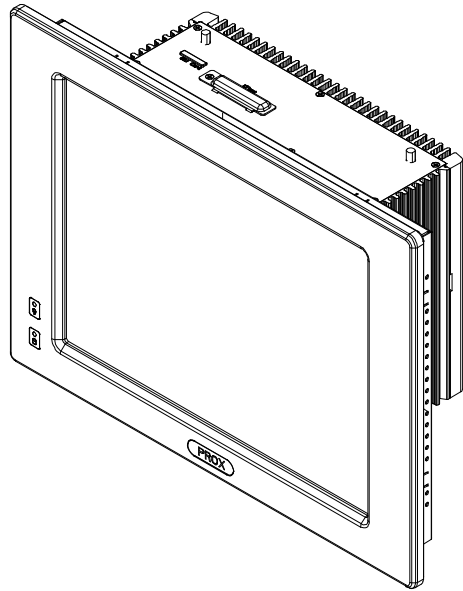

Unit: mm

SP-6207

Front View

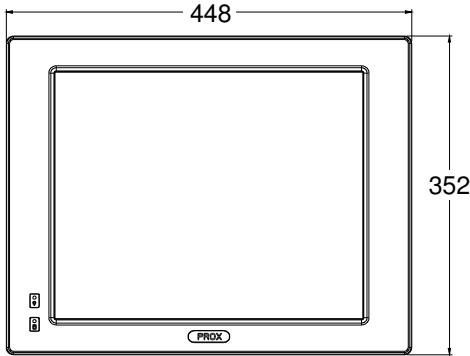

Rear View

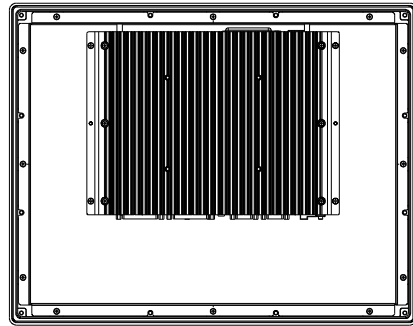

Top View

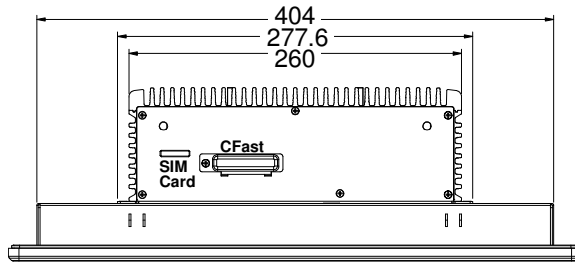

Bottom View

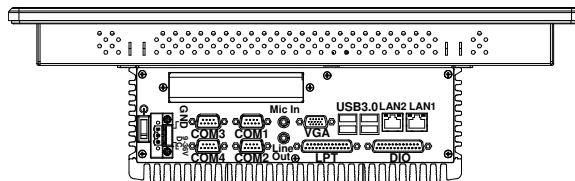

Unit: mm

Side View

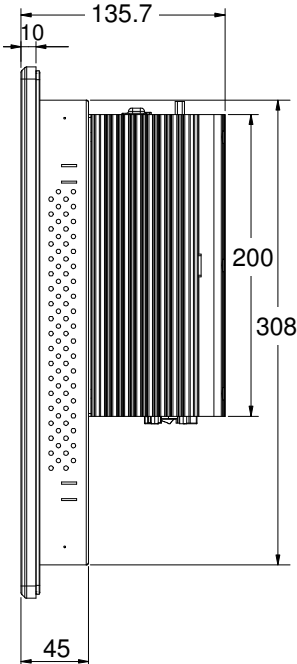

Quarter View

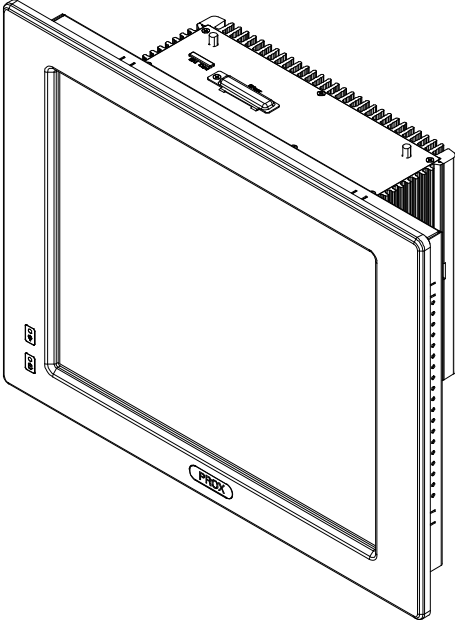

Unit: mm

6208

Front View

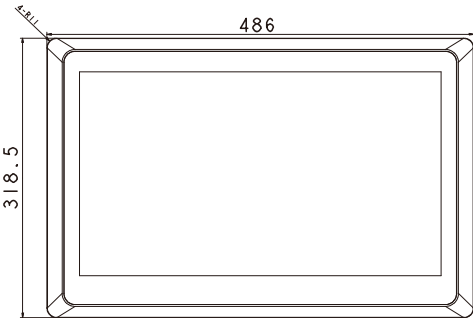

Rear View

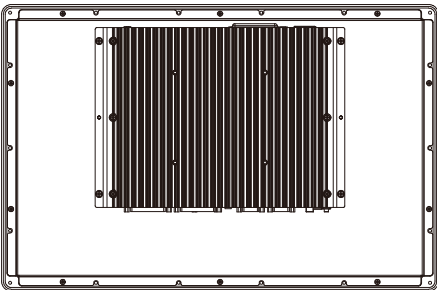

Top View

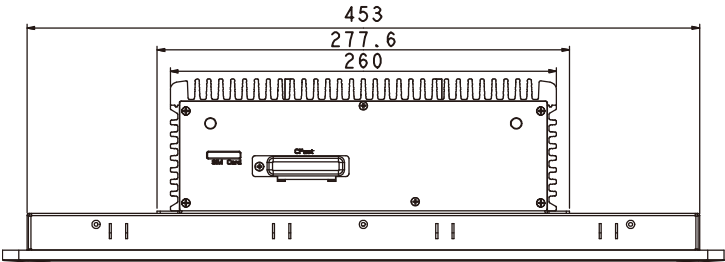

Bottom View

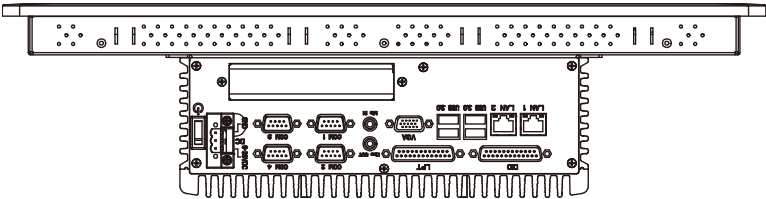

Unit: mm

Side View

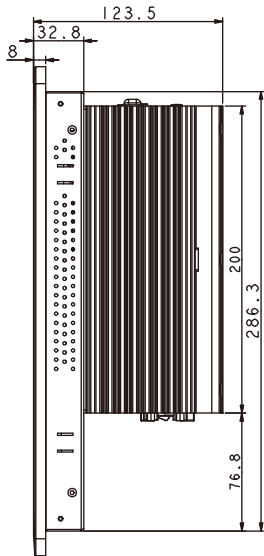

Quarter View

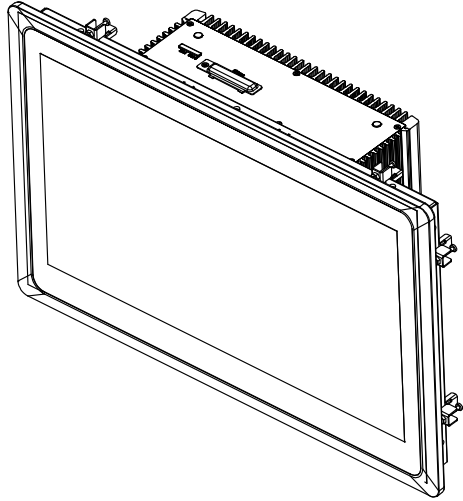

Unit: mm

SP-6209

Front View

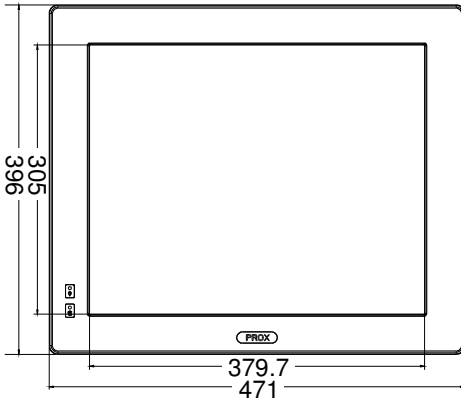

Rear View

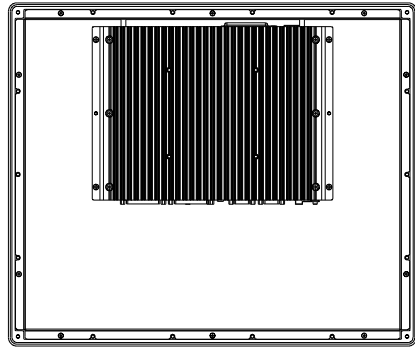

Top View

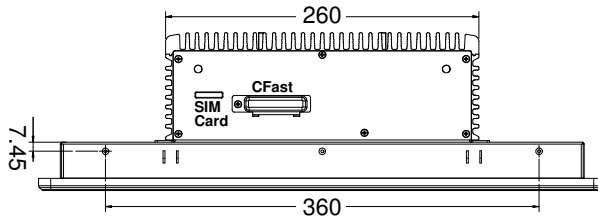

Bottom View

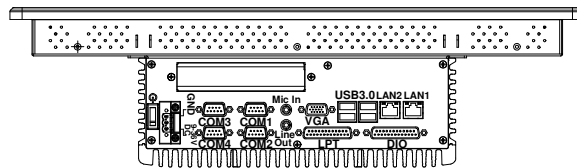

Unit: mm

Side View

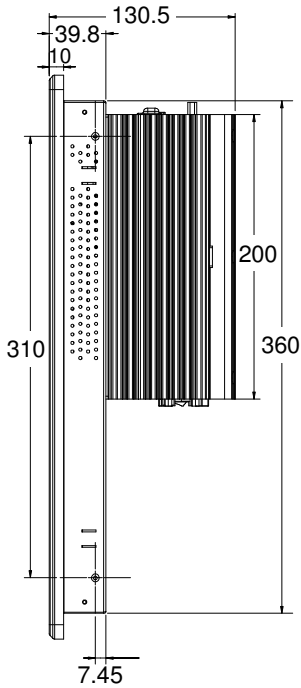

Quarter View

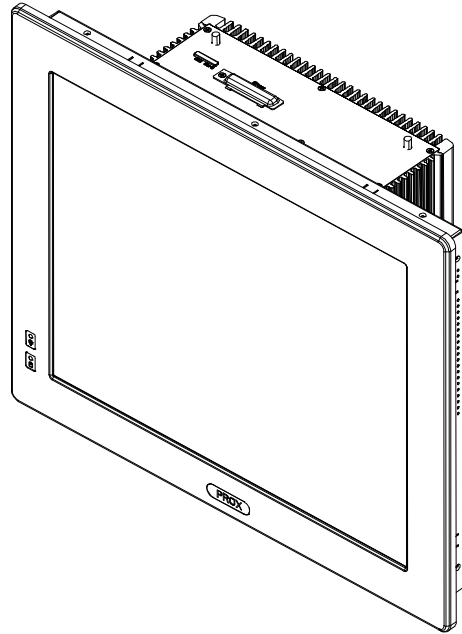

I/O View – SP-6205/6207/6208/209

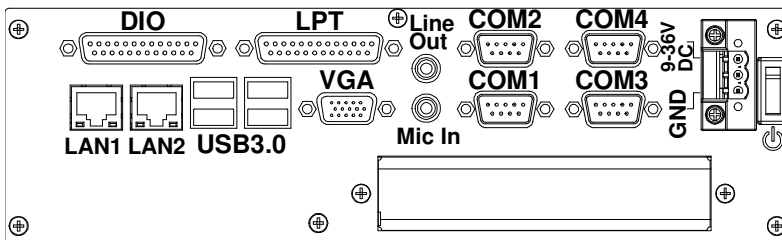

Unit: mm

1-3. SYSTEM SPECIFICATION

System

CPU Support	Intel® Core™ 3 rd Gen. Mobile i3/i5/i7 (rPGA-988) processor on board
Chipset	Intel® HM76/QM77
OS Support	Microsoft Windows XP/7
Memory Support	2 x 204pin DDR3 SO-DIMM, support DDR3/DDR3L 1600/1333/1066 up to 8GB/slot
Watchdog	1~255s Watchdog timer
Drive Bay	2 x 2.5" SATA HDD
Power Supply	DC-in 9~36V
Front Bezel	Aluminum
IP65	Front panel only
Mounting Type	VESA 100/Wall Mount
Net Weight	<ul style="list-style-type: none"> ▪ SP-6205: 7.5 kg ▪ SP-6207: 9 kg ▪ SP-6208: 10.15 kg ▪ SP-6209: 11.5 kg
Dimension (W x H x D)	<ul style="list-style-type: none"> ▪ SP-6205: 408 x 308 x 128 mm ▪ SP-6207: 448 x 352 x 136 mm ▪ SP-6208: 486 x 318.5 x 123.5 mm ▪ SP-6209: 471 x 396 x 131 mm
Certificate	FCC/CE

I/O Ports

Serial Port	4 x COM ports (pin-9 is RI/5V/12V selectable): <ul style="list-style-type: none"> ▪ COM1/3/4 for RS-232 ▪ COM2 for RS-232/422/485
USB	4 x USB 3.0
Parallel Port	1 x DSUB-25
VGA	1 x VGA
LAN	2 x LAN (10/100/1000 Mbps), support Wake-on-LAN:

	<ul style="list-style-type: none"> ▪ LAN1: Intel® 82579LM ▪ LAN2: Intel® 82583V
Audio	High Definition: <ul style="list-style-type: none"> ▪ 1 x Line-out ▪ 1 x MIC-in
Digital I/O	1 x DSUB-25 (8in/8out)
Expansion slot	<ul style="list-style-type: none"> ▪ 1 x Mini-PCIe slot (for WLAN module & 3G module) ▪ 1 x SIM card slot ▪ 1 x CFast card slot ▪ 1 x PCIe(4x), 10W/slot max. (Optional)

Display

LCD Panel Size	<ul style="list-style-type: none"> ▪ SP-6205: 15" ▪ SP-6207: 17" ▪ SP-6208: 18.5" ▪ SP-6209: 19"
Resolution (Brighness)	<ul style="list-style-type: none"> ▪ SP-6205: 1024 x 768 XGA 400nit LED backlight ▪ SP-6207: 1280 x 1024 SXGA 350nit LED backlight ▪ SP-6208: 1366 x 768 WXGA 300nit LED backlight ▪ SP-6209: 1280 x 1024 SXGA 300nit LED backlight
Touchscreen	(ELO) 5W Analog resistive (USB interface) For SP-6208: 18.5" Bezel-Free P-Capacitive T/P

Environment

Operation Temp. (with ambient airflow)	<ul style="list-style-type: none"> ▪ General: -5 ~ 45°C (23 ~ 113°F) ▪ CFast card (SP-6205/6207, Wide Temp. Grade, w/o audio): -5 ~ 55°C (23 ~ 131°F)
Storage Temp.	-20 ~ 80°C (-4 ~ 176°F)
Humidity	10 ~ 90%

1-4. SAFETY PRECAUTIONS

Follow the messages below to avoid your systems from damage:

1. Keep your system away from static electricity on all occasions.
2. Prevent electric shock. Don't touch any components of this card when the card is power-on. Always disconnect power when the system is not in use.
3. Disconnect power when you change any hardware devices. For instance, when you connect a jumper or install any cards, a surge of power may damage the electronic components or the whole system.

HARDWARE CONFIGURATION

CHAPTER

2

**** *QUICK START* ****

Helpful information describes the jumper & connector settings, and component locations.

Section includes:

- Jumper & Connector Quick Reference Table
- Component Locations
- Configuration and Jumper settings
- Connector's Pin Assignments

2-1. JUMPER & CONNECTOR QUICK REFERENCE TABLE

JUMPER/CONNECTOR	NAME
Clear CMOS Data Selection	JP5
CFAST Voltage Selection	JP8
COM Ports	COM1, COM2, COM3, COM4
COM Ports RI & Voltage Selection	JP15, JP16, JP17, JP18
COM2 RS232/422/485 Selection	JP13
COM2 Auto Detect Selection	JP12
Digital I/O Connector	DIO1
Flash Descriptor Override Selection	JP3
Front Panel Selection	PWRBTN1, HDDLED1, SYSRST1, PWRLED1
Internal Keyboard & Mouse Connectors	KB1, MS1
Hardware Power Failure Selection	JP7
JUSB Connector	JUSB1
LAN Connectors	LAN1, LAN2
Printer Connector	LPT1
LVDS Connector	LVDS1
LVDS Inverter Connector	INV1
LVDS Panel Brightness Control	JP21
LVDS Voltage Selection	JP19
Power Input Connector	PWR_IN1, ATX_PWR1
SATA & SATA Power Connectors	SATA1, SATA_PWR1, SATA2, SATA_PWR2
Audio Connectors	AUDIO1, LINE_IN1
System Fan Connector	SYS_FAN1
USB3.0 Connectors	USB1, USB2
VGA Connector	VGA1
SIM Card Slot	SIM1

2-2. COMPONENT LOCATIONS

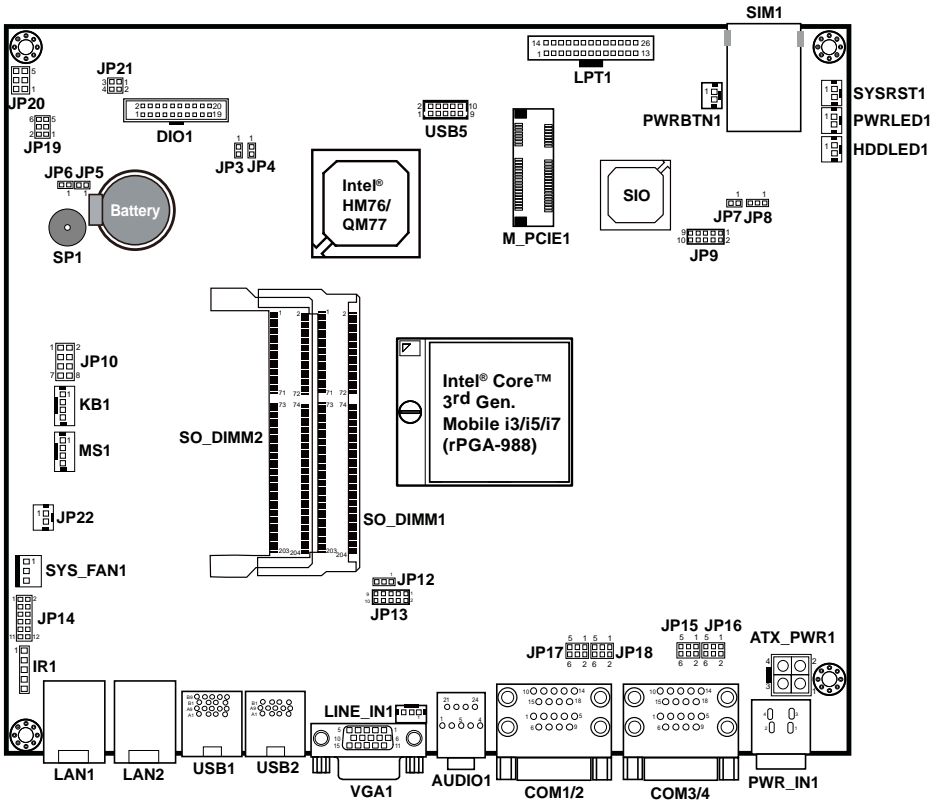

SP-6205/6207/6208/6209 Connectors, Jumpers and Components Locations

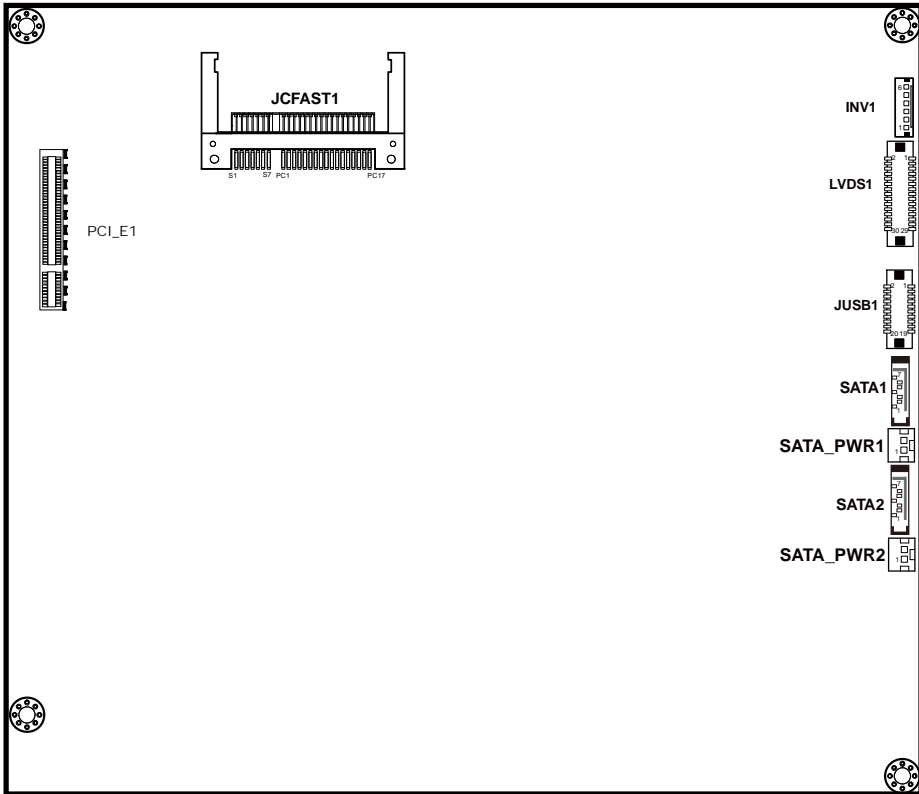

SP-6205/6207/6208/6209 Connectors, Jumpers and Components Locations

2-3. HOW TO SET JUMPERS

You can configure your board by setting jumpers. Jumper is consists of two or three metal pins with a plastic base mounted on the card, and by using a small plastic "cap", Also known as the jumper cap (with a metal contact inside), you are able to connect the pins. So you can set-up your hardware configuration by "open" or "close" pins.

The jumper can be combined into sets that called jumper blocks. When the jumpers are all in the block, you have to put them together to set up the hardware configuration. The figure below shows how this looks like.

JUMPERS AND CAPS

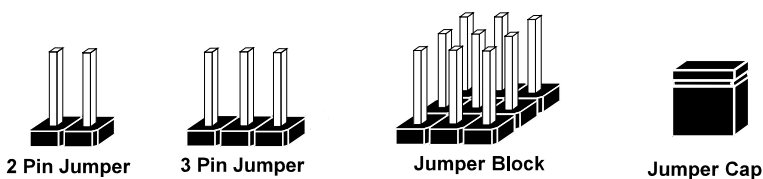

If a jumper has three pins (for examples, labelled PIN1, PIN2, and PIN3), You can connect PIN1 & PIN2 to create one setting by shorting. You can either connect PIN2 & PIN3 to create another setting. The same jumper diagrams are applied all through this manual. The figure below shows what the manual diagrams look and what they represent.

JUMPER DIAGRAMS



Jumper Cap
looks like this

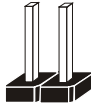

2 pin Jumper
looks like this

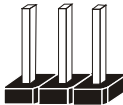

3 pin Jumper
looks like this

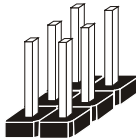

Jumper Block
looks like this

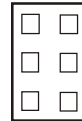

JUMPER SETTINGS



2 pin Jumper close(enabled)
Looks like this



3 pin Jumper
2-3 pin close(enabled)
Looks like this





Jumper Block
1-2 pin close(enabled)
Looks like this



2-4. CLEAR CMOS DATA SELECTION

JP5 : Clear CMOS Data Selection

The jumper setting is as follows:

SELECTION	JUMPER SETTINGS	JUMPER ILLUSTRATION
Normal	Open	 JP5
Clear CMOS*	Close	 JP5



Note: Manufacturing Default is Normal.

*To clear CMOS data, user must power-off the computer and set the jumper to “Clear CMOS” as illustrated above. After five to six seconds, set the jumper back to “Normal” and power-on the computer.

2-5. CFAST VOLTAGE SELECTION

JP8 : CFast Voltage Selection

The jumper setting is as follows:

SELECTION	JUMPER SETTINGS	JUMPER ILLUSTRATION
3.3V	1-2	 JP8
5V	2-3	 JP8

Note: Manufacturing Default is 3.3V.

2-6. COM PORTS

COM1, COM3, COM4: COM Ports, fixed as RS-232

The pin assignments are as follows:

PIN	ASSIGNMENT	PIN	ASSIGNMENT
1	DCD#	6	DSR#
2	RX	7	RTS#
3	TX	8	CTS#
4	DTR#	9	RI#
5	GND		

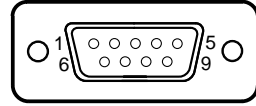

COM1/
COM2/
COM3/
COM4

COM2: COM2 Connector, selectable as RS-232/422/485

The pin assignments are as follows:

PIN	ASSIGNMENT		
	RS-232	RS-422	RS-485
1	DCD#	TX-	RS-485-
2	RX	TX+	RS-485+
3	TX	RX+	X
4	DTR#	RX-	X
5	GND	GND	GND
6	DSR#	X	X
7	RTS#	X	X
8	CTS#	X	X
9	RI#	X	X

2-7. COM PORTS RI & VOLTAGE SELECTION

JP18, JP17, JP16, JP15: COM1/2/3/4 Ports RI & Voltage Selection

The selections are as follows:

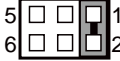
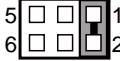
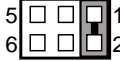
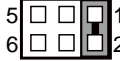
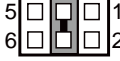
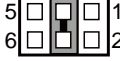
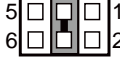
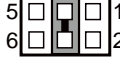
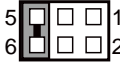
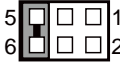
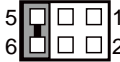
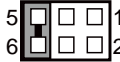

SELECTION	JUMPER SETTING	JUMPER ILLUSTRATION			
		COM1	COM2	COM3	COM4
RI	1-2	 JP18	 JP17	 JP16	 JP15
VCC12	3-4	 JP18	 JP17	 JP16	 JP15
VCC	5-6	 JP18	 JP17	 JP16	 JP15

Note: Manufacturing Default is RI.

2-8. COM2 RS-232/422/485 SELECTION

JP13: COM2 RS-232/422/485 Selection

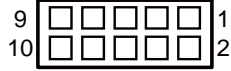
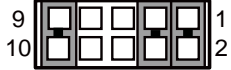
The selections are as follows:



SELECTION	JUMPER SETTINGS	JUMPER ILLUSTRATION
RS-232	All open	 <p>JP13</p>
RS-422	1-2, 3-4, 9-10	 <p>JP13</p>
RS-485	1-2, 5-6, 7-8	 <p>JP13</p>

Note: Manufacturing Default is RS-232.

2-9. COM2 AUTO DETECT SELECTION

JP12: COM2 Auto Detect Selection

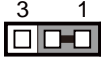
The selections are as follows:

SELECTION	JUMPER SETTINGS	JUMPER ILLUSTRATION
Normal	1-2	 JP12
Auto	2-3	 JP12

Note: Manufacturing Default is Auto.

2-10. DIGITAL I/O CONNECTOR

DIO1: DIO Connector

The pin assignments are as follows:

PIN	ASSIGNMENT	PIN	ASSIGNMENT
1	VCC5	11	DIN5
2	VCC12	12	DOUT5
3	DIN1	13	DIN6
4	DOUT1	14	DOUT6
5	DIN2	15	DIN7
6	DOUT2	16	DOUT7
7	DIN3	17	DIN8
8	DOUT3	18	DOUT8
9	DIN4	19	GND
10	DOUT4	20	GND

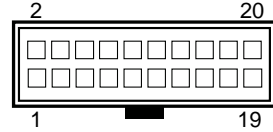

DIO1

System Digital I/O Port D-SUB-25 pin

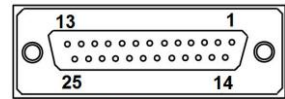



DIO Port

PIN	ASSIGNMENT	PIN	ASSIGNMENT
1	DIN1	14	DOUT1
2	DIN2	15	DOUT2
3	DIN3	16	DOUT3
4	DIN4	17	DOUT4
5	DIN5	18	DOUT5
6	DIN6	19	DOUT6
7	DIN7	20	DOUT7
8	DIN8	21	DOUT8
9	NC	22	NC
10	NC	23	NC
11	NC	24	VCC12
12	VCC5	25	GND
13	GND	-	-

2-11. FLASH DESCRIPTOR OVERRIDE SELECTION

JP3: Flash Descriptor Override Selection

The selections are as follows:

SELECTION	JUMPER SETTINGS	JUMPER ILLUSTRATION
Disable	Open	 JP3
Enable	Close	 JP3

Note: Manufacturing Default is Disable.

2-12. FRONT PANEL CONNECTORS

PWRBTN1: ATX Power Button Connector

The pin assignments are as follows:

PIN	ASSIGNMENT
1	PWR_BTN
2	GND



PWRBTN1

HDDLED1: Hard Disk Drive LED Connector

The pin assignments are as follows:

PIN	ASSIGNMENT
1	HDD_LED+
2	HDD_LED-



HDDLED1

SYSRST1: Reset Connector

The pin assignments are as follows:

PIN	ASSIGNMENT
1	RST_BTN
2	GND



SYSRST1

PWRLED1: Power LED Connector

The pin assignments are as follows:

PIN	ASSIGNMENT
1	PWR_LED+
2	GND



PWRLED1

2-13. INTERNAL KEYBOARD & MOUSE CONNECTORS

KB1: Keyboard Connector

The pin assignments are as follows:

PIN	ASSIGNMENT
1	KBCLK
2	KBDATA
3	GND
4	5VSB

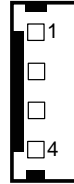

**KB1/
MS1**

MS1: Mouse Connector

The pin assignments are as follows:

PIN	ASSIGNMENT
1	MSCLK
2	MSDATA
3	GND
4	5VSB

2-14. HARDWARE POWER FAILURE SELECTION

JP7: Hardware Power Failure Selection

The selections are as follows:

SELECTION	JUMPER SETTINGS	JUMPER ILLUSTRATION
Disable	Open	<p>1 JP7</p>
Enable	Close	<p>1 JP7</p>

Note: Manufacturing Default is Disable.

2-15. JUSB CONNECTOR

JUSB1: JUSB Connector

The pin assignments are as follows:

PIN	ASSIGNMENT	PIN	ASSIGNMENT
1	5VSB	11	USB_N5
2	5VSB	12	12V
3	USB_N4	13	USB_P5
4	12V	14	CSATA_LED
5	USB_P4	15	GND
6	12V	16	PWR_LED_R
7	GND	17	GND
8	12V	18	USB_OCJ1
9	LVDS_BKLT_EN	19	5V
10	12V	20	USB_OCJ2

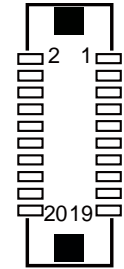

JUSB1

2-16. LAN PORTS

LAN1, LAN2: LAN Ports

The pin assignments are as follows:

PIN	ASSIGNMENT	PIN	ASSIGNMENT
1	MDI_P0	5	MDI_P2
2	MDI_N0	6	MDI_N2
3	MDI_P1	7	MDI_P3
4	MDI_N1	8	MDI_N3

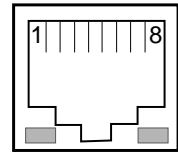

Green Yellow

LAN1/

LAN2

LAN LED Indicator:

Left Side LED

Green Color On	10/100 LAN Speed Indicator
Orange Color On	Giga LAN Speed Indicator
Off	No LAN switch/hub connected.

Right Side LED

Yellow Color Blinking	LAN Message Active
Off	No LAN Message Active

2-17. PRINTER CONNECTOR

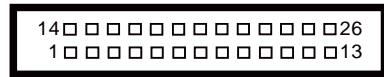

LPT1: Printer Connector

PIN	ASSIGNMENT	PIN	ASSIGNMENT
1	STBJ	14	ALFJ
2	PDR0	15	ERRJ
3	PDR1	16	PAR_INITJ
4	PDR2	17	SLCTINJ
5	PDR3	18	GND
6	PDR4	19	GND
7	PDR5	20	GND
8	PDR6	21	GND
9	PDR7	22	GND
10	ACKJ	23	GND
11	BUSY	24	GND
12	PE	25	GND
13	SLCTJ	26	NC

LPT1

System LPT Port Connector D-SUB-25 pin

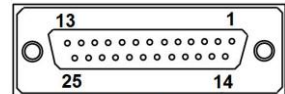

LPT Port

PIN	ASSIGNMENT	PIN	ASSIGNMENT
1	STBJ	14	ALFJ
2	PDR0	15	ERRJ
3	PDR1	16	PAR_INITJ
4	PDR2	17	SLCTINJ
5	PDR3	18	GND
6	PDR4	19	GND
7	PDR5	20	GND
8	PDR6	21	GND
9	PDR7	22	GND
10	ACKJ	23	GND
11	BUSY	24	GND
12	PE	25	GND
13	SLCTJ	-	-

2-18. LVDS CONNECTOR

LVDS1: LVDS Connector

The pin assignments are as follows:

PIN	ASSIGNMENT	PIN	ASSIGNMENT
1	LVDS_VCC	16	LVDS0_CLK+ (Odd)
2	GND	17	LVDS0_CLK- (Odd)
3	LVDS1_CLK- (Even)	18	GND
4	LVDS1_CLK+ (Even)	19	LVDS0_D2+ (Odd)
5	GND	20	LVDS0_D2- (Odd)
6	LVDS1_D2- (Even)	21	GND
7	LVDS1_D2+ (Even)	22	LVDS0_D1+ (Odd)
8	GND	23	LVDS0_D1- (Odd)
9	LVDS1_D1- (Even)	24	GND
10	LVDS1_D1+ (Even)	25	LVDS0_D0+ (Odd)
11	LVDS1_D3+ (Even)	26	LVDS0_D0- (Odd)
12	LVDS1_D3- (Even)	27	LVDS0_D3+ (Odd)
13	LVDS1_D0+ (Even)	28	LVDS0_D3- (Odd)
14	LVDS1_D0- (Even)	29	LVDS_VCC
15	GND	30	LVDS_VCC

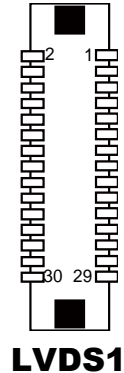

2-19. LVDS INVERTER CONNECTOR

INV1: LVDS Inverter Connector

The pin assignments are as follows:

PIN	ASSIGNMENT	PIN	ASSIGNMENT
1	VCC12	4	PWM
2	VCC12	5	GND
3	GND	6	ENABKL

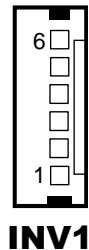

2-20. LVDS PANEL BRIGHTNESS CONTROL SELECTION

JP21: LVDS Panel Brightness Control Selection

The selections are as follows:

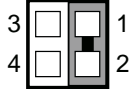
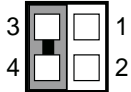
SELECTION	JUMPER SETTINGS	JUMPER ILLUSTRATION
Up	1-2	 <p>JP21</p>
Down	3-4	 <p>JP21</p>

Note: Manufacturing Default is Disable.

2-21. LVDS VOLTAGE SELECTION

JP19: LVDS Voltage Selection

The selections are as follows:

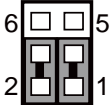
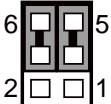
SELECTION	JUMPER SETTINGS	JUMPER ILLUSTRATION
3.3V	1-3, 2-4	 <p>JP19</p>
5V	3-5, 4-6	 <p>JP19</p>

Note: Manufacturing Default is 3.3V.

2-22. POWER INPUT CONNECTOR

PWR_IN1: Power Input Connector
The pin assignments are as follows:

PIN	ASSIGNMENT
1	GND
2	GND
3	VCC
4	VCC

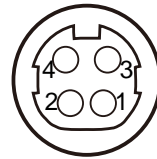

PWR_IN1

System Power Input Connector: 3-pin terminal block

PIN	ASSIGNMENT
1	VCC: 9 ~ 36 VDC
2	VDD: 0 VDC
3	GND

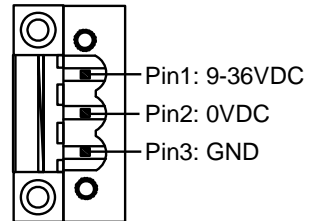

**Power Input Connector
(3-pin terminal block)**

Power Input Connector Connection: Connect 3-pin terminal block to 4-pin PWR_IN1

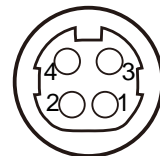
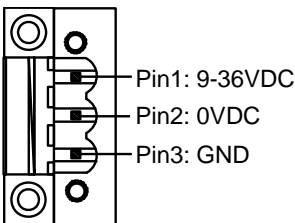

PWR_IN1

3-Pin Terminal Block	4-Pin PWR_IN1	ASSIGNMENT
1	3	VCC: 9 ~ 36 VDC
	4	
2	Metal Shield	VDD: 0 VDC
3	1	GND
	2	

ATX_PWR1: Option Power Input Connector
 The pin assignments are as follows:

PIN	ASSIGNMENT
1	GND
2	GND
3	VCC
4	VCC

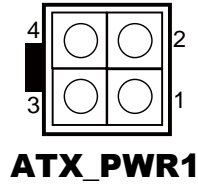

2-23. SATA & SATA POWER CONNECTORS

SATA1, SATA2: SATA Connectors
 The pin assignments are as follows:

SATA1:

PIN	ASSIGNMENT	PIN	ASSIGNMENT
1	GND	5	SATA_RXN0
2	SATA_TXP0	6	SATA_RXP0
3	SATA_TXN0	7	GND
4	GND		



**SATA1/
SATA2**

SATA2:

PIN	ASSIGNMENT	PIN	ASSIGNMENT
1	GND	5	SATA_RXN1
2	SATA_TXP1	6	SATA_RXP1
3	SATA_TXN1	7	GND
4	GND		

SATA_PWR1, SATA_PWR2: SATA Power Connectors

The pin assignments are as follows:

PIN	ASSIGNMENT
1	VCC5
2	GND

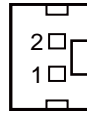

**SATA_PWR1/
SATA_PWR2**

2-24. AUDIO CONNECTOR

AUDIO1: Audio Connector

The pin assignments are as follows:

MIC_IN: (pink)

PIN	ASSIGNMENT
1	MIC_IN_R
2	NC
3	NC
4	MIC_IN_L
5	GND

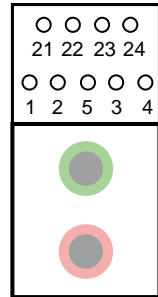

AUDIO1

LINE_OUT: (green)

PIN	ASSIGNMENT
21	LINE_OUT_R
22	NC
23	NC
24	LINE_OUT_L

LINE_IN1: Line-in Connector

The pin assignments are as follows:

PIN	ASSIGNMENT
1	LINE_IN_R
2	GND
3	LINE_IN_L

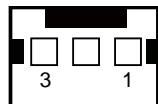

LINE_IN1

2-25. SYSTEM FAN CONNECTOR

SYS_FAN1: System Fan Connector

The pin assignments are as follows:

PIN	ASSIGNMENT
1	GND
2	SYS_FAN_CTL
3	SYS_FAN_TAC

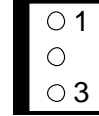

SYS_FAN1

2-26. USB 3.0 PORTS

USB1, USB2: USB Ports

The pin assignments are as follows:

PIN	ASSIGNMENT	PIN	ASSIGNMENT
A1	USB_VCC5	B1	USB_VCC5
A2	USB_N1	B2	USB_N2
A3	USB_P1	B3	USB_P2
A4	GND	B4	GND
A5	USB3_1RXN	B5	USB3_2RXN
A6	USB3_1RXP	B6	USB3_2RXP
A7	GND	B7	GND
A8	USB3_1TXN	B8	USB3_2TXN
A9	USB3_1TXP	B9	USB3_2TXP

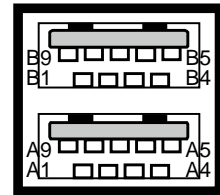

**USB1/
USB2**

2-27. VGA PORT

VGA1: VGA Port

The pin assignments are as follows:

PIN	ASSIGNMENT	PIN	ASSIGNMENT
1	CRT_RED	9	CRT_VCC
2	CRT_GREEN	10	GND
3	CRT_BLUE	11	NC
4	NC	12	CRT_DATA
5	GND	13	CRT_HSYNC
6	NC	14	CRT_VSYNC
7	GND	15	CRT_CLK
8	GND		

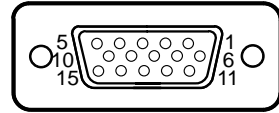

VGA1

2-28. SIM CARD SLOT

SIM1: SIM Card Slot

The pin assignments are as follows:

PIN	ASSIGNMENT	PIN	ASSIGNMENT
C1	PWR	C6	VPP
C2	RESET	C7	DATA
C3	CLK	CO1	SW1
C5	GND	CO2	SW2

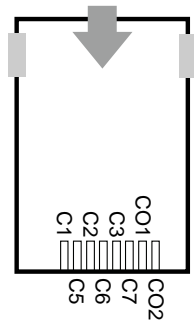

SIM1

SOFTWARE UTILITIES

CHAPTER 3

This chapter comprises the detailed information of VGA driver, LAN driver, and Sound driver.

Section includes:

- Introduction
- Intel® Chipset Software Installation Utility
- Intel® USB3.0 eXtensible Host Controller Utility
- Intel® Management Engine Components Utility
- VGA Driver Utility
- LAN Driver Utility
- Sound Driver Utility
- Touchscreen Driver Utility

3-1. INTRODUCTION

Enclosed with our SP-6205/6207/6208/6209 package, you will find a CD ROM disk containing all types of drivers we have. As a SP-6205/6207/6208/6209 user, you will only need some of files contained in the CD ROM disk, please take note of the following chart:

FILE NAME (Assume that CD ROM drive is D:)	PURPOSE
D:\Driver\UTILITY	Intel® Chipset Software Installation Utility
D:\Driver\USB	Intel® USB3.0 eXtensible host controller driver for Intel® 7 Series/C216 Chipset Family
D:\Driver\ME	Intel® Management Engine 8 5M 8.0.10.1464 driver installation
D:\Driver\VGA	Intel® Graphics Media Accelerator 3600 Series for VGA driver installation
D:\Driver\ LAN	Realtek RTL8111F for LAN driver installation
D:\Driver\Sound	Realtek ALC888S High Definition Audio for sound driver installation
D:\Driver\Touch driver	eGalaxTouch-. 12.0.10517 Controller for Windows installation

Note: Be sure to install the Utility right after the OS is fully installed.

3-2. INTEL® CHIPSET SOFTWARE INSTALLATION UTILITY

3-2-1. Introduction

The Intel® Chipset Device Software installs Windows *.INF files to the target system. These files outline to the operating system how to configure the Intel® chipset components in order to ensure that the following features function properly:

- PCIe Support
- SATA Storage Support
- USB Support
- Identification of Intel® Chipset Components in the Device Manager

3-2-2. Installation of Utility for Windows XP/7/8

The Utility Pack is made only for Windows XP/7/8. It should be installed right after the OS installation; kindly follow the following steps:

1. Place insert the Utility Disk into Floppy Disk Drive A/B or CD ROM drive.
2. Under Windows system, go to the directory where Utility Disc is located.
e.g.: D:\Driver\Platform\OS\Utility\infinst_autol.exe
3. Click infinst_autol.exe file for utility installation.
4. Follow the instructions on the screen to complete the installation.
5. Once installation is completed, shut down the system and restart in order for the changes to take effect.

3-3. INTEL® USB3.0 EXTENSIBLE HOST CONTROLLER UTILITY

3-3-1. Introduction

Intel® USB 3.0 eXtensible Host Controller Driver supports the following Intel® Chipset/Processors:

- Intel® 7 Series/C216 Chipset Family
- 3rd Generation Intel® Core™ Processor Family
- 2nd Generation Intel® Core™ i3 Processors
- 2nd Generation Intel® Core™ i5 Processor
- 2nd Generation Intel® Core™ i7 processor
- 2nd Generation Intel® Core™ i7 Extreme processor

Intel® 7 Series/C216 Chipset Family supports Windows 7 Operating System 32-bit & 64-bit.

Note: The Intel® USB 3.0 eXtensible Host Controller Driver is not supported on Windows XP* and Vista*.

3-3-2. Installation Instructions for Windows 7/8

1. Insert the driver disk into a CD ROM device.
2. Under Windows system, go to the directory where the driver is located.
3. Run the application with administrative privileges.

3-4. INTEL® MANAGEMENT ENGINE COMPONENTS UTILITY

3-4-1. Introduction

The Intel® ME software components that need to be installed depend on the system's specific hardware and firmware features. The installer, compatible with Windows XP/7, detects the system's capabilities and installs the relevant drivers and applications.

3-4-2. Installation Instructions for Windows XP/7/8

1. Insert the driver disk into a CD ROM device.
2. Under Windows system, go to the directory where the driver is located.
3. Run the application with administrative privileges.

3-5. VGA DRIVER UTILITY

The VGA interface is embedded with our SP-6205/6207/6208/6209 system to support CRT display. The following illustration briefly shows you the content of VGA driver.

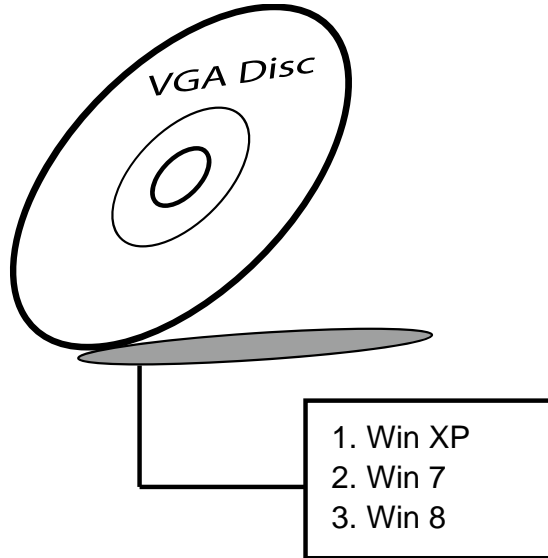

3-5-1. Installation of VGA Driver for Windows XP/7/8

1. Start the computer.
2. Insert the Utility Disk into the CD ROM drive or drive A/B.
3. Open the VGA folder for your system to choose an appropriate folder, and double-click "*.exe" file to install.
e.g. D:\Driver\Platform\<OS>\Graphics\Your system\ ***.exe
(If D is not your CD-ROM drive, substitute D with the correct drive letter.)
4. Follow the Wizard's on-screen instructions to complete the installation.

3-6. LAN DRIVER UTILITY

3-6-1. Introduction

The SP-6205/6207/6208/6209 is enhanced with LAN function that can support various network adapters. The content of the LAN driver is found as follows:

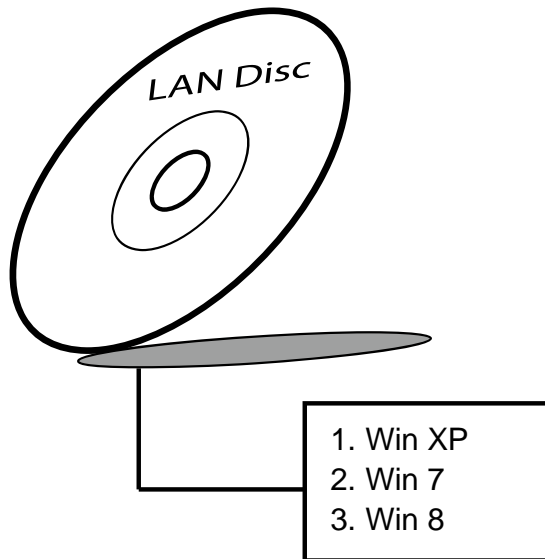

For more details on Installation procedure, please refer to Readme.txt file found on LAN DRIVER UTILITY.

3-7. SOUND DRIVER UTILITY

3-7-1. Introduction

The Audio chip enhanced in this system is fully compatible with Windows XP/7. Below, you will find the content of the Sound driver:

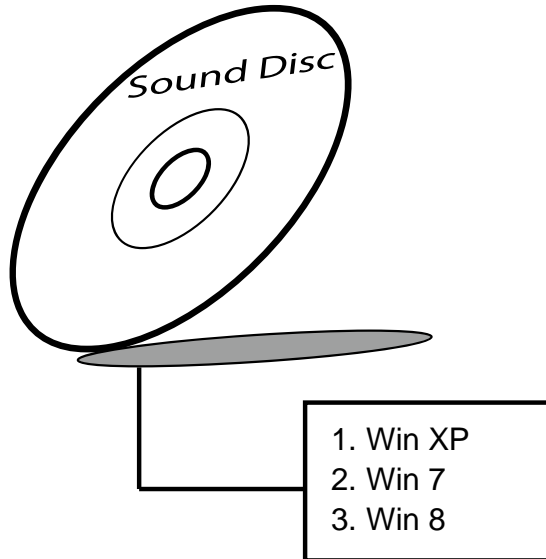

3-7-2. Installation Procedure for Windows XP/7/8

1. Open the "Sound" folder. For your system to choose an appropriate folder, and Run the setup.exe program to start the installation.
e.g.: D:\Driver\Platform\OS\ SOUND\Your system\setup.exe
(If D is not your CD-ROM drive, substitute D with the correct drive letter.)
2. Click on [Next] to continue the procedure. If the Windows popup "Windows can't verify the publisher of this driver software" message, press "Install this driver software anyway" to continue the installation.
3. Finally, select to restart the system and press [Finish] to complete the installation.

3-8. TOUCHSCREEN DRIVER UTILITY

The touch screen driver utility can only be installed on Windows XP/7/8, and it should be installed right after the OS installation.

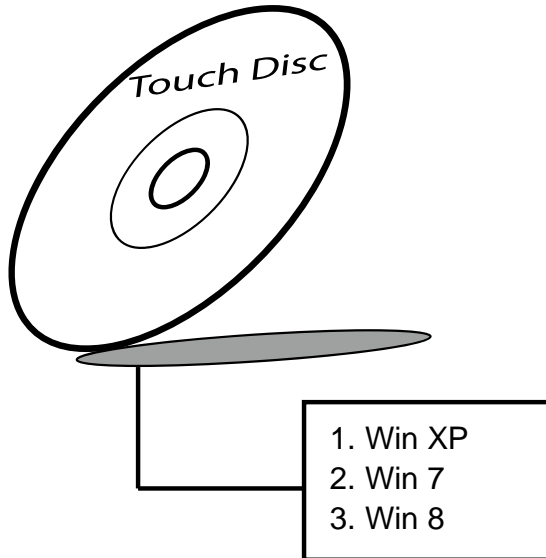

3-8-1. Installation of Touchscreen Driver

To install the touchscreen driver, follow the steps below:

1. Open the "Device/Touchscreen" folder where the touchscreen driver is located.
2. Click **Setup.exe** file for driver installation.
3. Follow the on-screen instructions to complete the installation.
4. Once installation is completed, shut down the system and restart for the changes to take effect.

AMI BIOS SETUP

CHAPTER

4

This chapter shows how to set up the AMI BIOS.

Section includes:

- Introduction
- Entering Setup
- Main
- Advanced
- Chipset
- Boot
- Security
- Save & Exit

4-1. INTRODUCTION

The system SP-6205/6207/6208/6209 uses an AMI Aptio BIOS that is stored in the Serial Peripheral Interface Flash Memory (SPI Flash) and can be updated. The SPI Flash contains the BIOS Setup program, Power-on Self-Test (POST), the PCI auto-configuration utility, LAN EEPROM information, and Plug and Play support.

Aptio is AMI’s BIOS firmware based on the UEFI (Unified Extensible Firmware Interface) Specifications and the Intel Platform Innovation Framework for EFI. The UEFI specification defines an interface between an operating system and platform firmware. The interface consists of data tables that contain platform-related information, boot service calls, and runtime service calls that are available to the operating system and its loader. These provide standard environment for booting an operating system and running pre-boot applications.

Following illustration shows Extensible Firmware Interface’s position in the software stack.

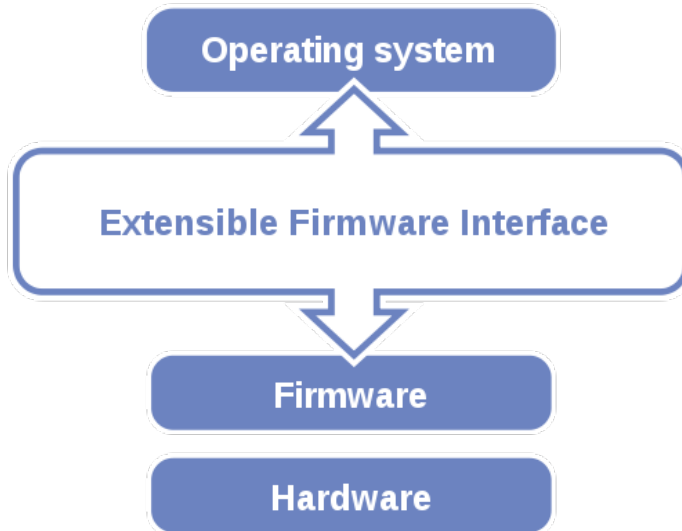

EFI BIOS provides an user interface allow users the ability to modify hardware configuration, e.g. change system date and time, enable or disable a system component, decide bootable device priorities, setup personal password, etc., which is convenient for modifications and customization of the computer system and allows technicians another method for finding solutions if hardware has any problems.

The BIOS Setup program can be used to view and change the BIOS settings for the computer. The BIOS Setup program is accessed by pressing the or <F2> key after the POST memory test begins and before the operating system boot begins. The settings are shown below.

4-2. ENTERING SETUP

When the system is powered on, the BIOS will enter the Power-On Self Test (POST) routines and the following message will appear on the lower screen:



POST screen

As long as this message is present on the screen you may press the key (the one that shares the decimal point at the bottom of the number keypad) to access the Setup program. In a moment, the main menu of the Aptio Setup Utility will appear on the screen:

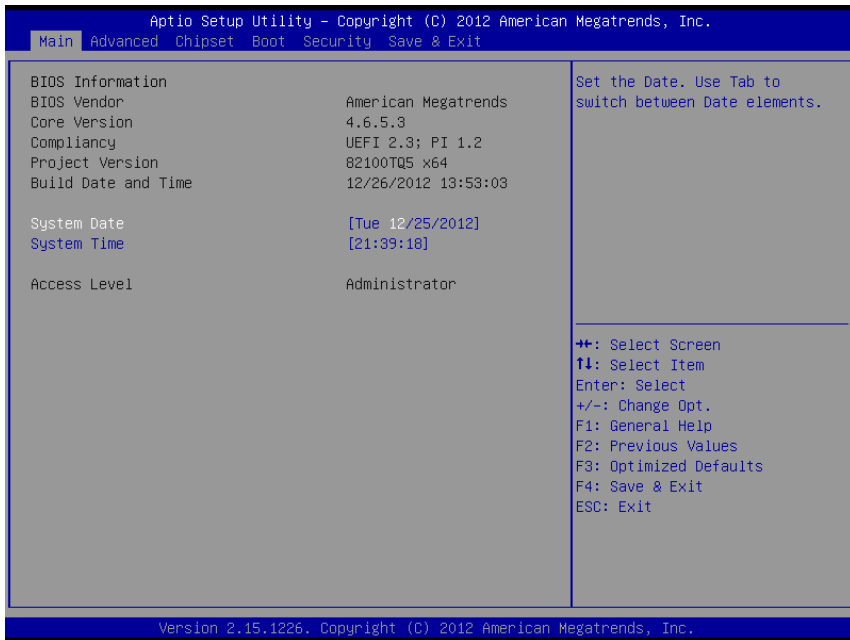

Setup program initial screen

You may move the cursor by up/down keys to highlight the individual menu items. As you highlight each item, a brief description of the highlighted selection will appear at the bottom of the screen.

4-3. Main

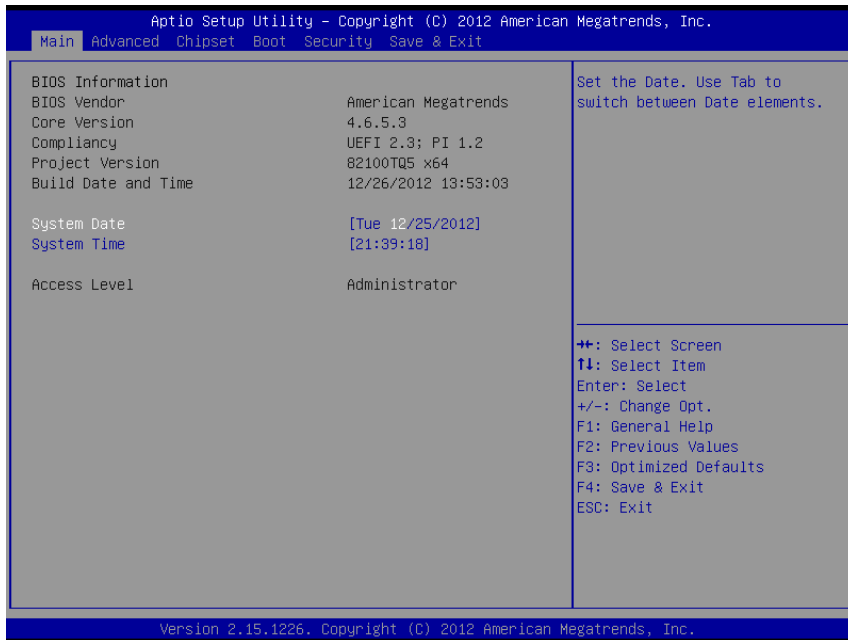

Main Screen

BIOS Setting	Options	Description/Purpose
BIOS Vendor	No changeable options	Displays the BIOS vendor.
Core Version	No changeable options	Displays the current BIOS core version.
Project Version	No changeable options	Displays the version of the BIOS currently installed on the platform.
Build Date	No changeable options	Displays the date of current BIOS version.
System Date	month, day, year	Specifies the current date.
System Time	hour, minute, second	Specifies the current time.

4-4. Advanced

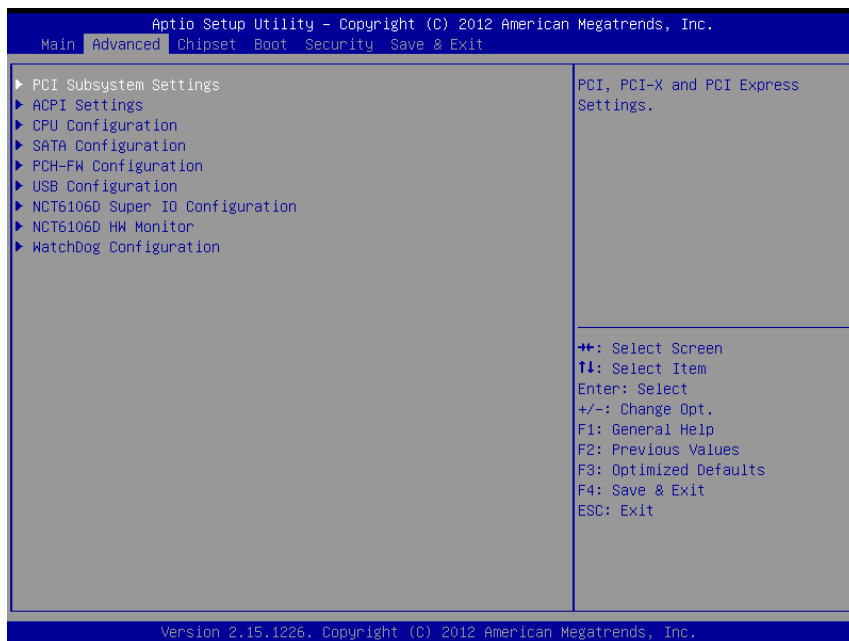

Advanced Screen

4-4-1. Advanced – PCI Subsystems Settings

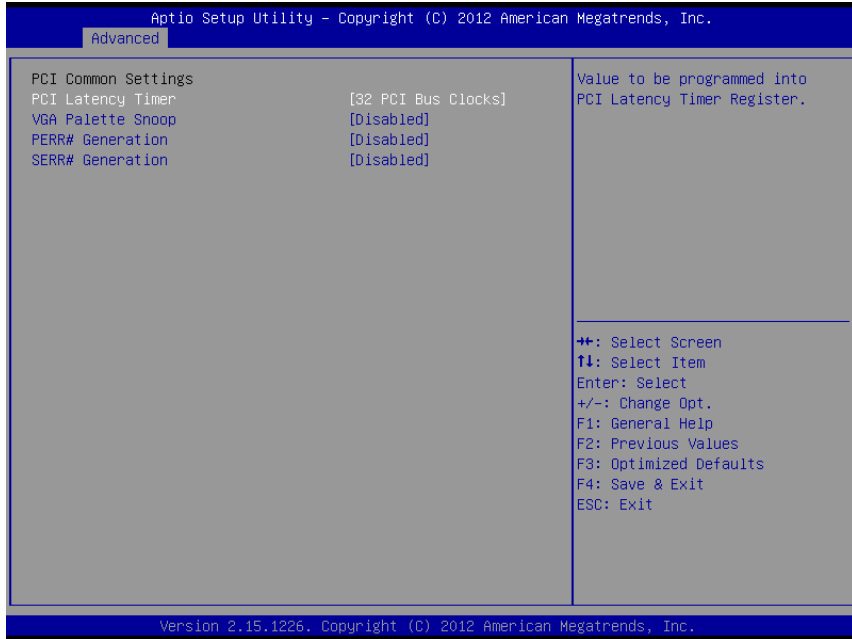

PCI Subsystems Settings Screen

BIOS Setting	Options	Description/Purpose
PCI Latency Timer	-32 PCI Bus Clocks -64 PCI Bus Clocks -96 PCI Bus Clocks -128 PCI Bus Clocks -160 PCI Bus Clocks -192 PCI Bus Clocks -224 PCI Bus Clocks -248 PCI Bus Clocks	Sets PCI latency time.
VGA Palette Snoop	-Disabled -Enabled	Some non-standard VGA cards or MPEG video cards may not show colors properly. Setting this function to Enabled can correct this problem.
PERR# Generation	-Disabled	Enables or Disables PCI Device to

BIOS Setting	Options	Description/Purpose
	-Enabled	Generate PERR#.
SERR# Generation	-Disabled -Enabled	Enables or Disables PCI Device to Generate SERR#.

4-4-2. Advanced - ACPI Settings

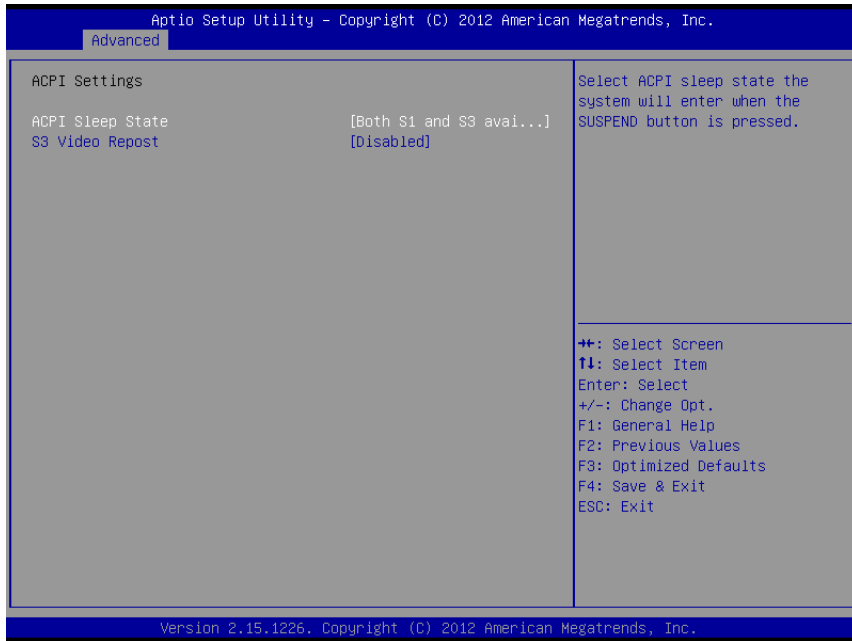

ACPI Settings Screen

BIOS Setting	Options	Description/Purpose
ACPI Sleep State	-Suspend Disabled -S1 only(CPU Stop Clock) -S3 only(Suspend to RAM) -Both S1 and S3 available for OS to choose from	Select the highest ACPI sleep state the system will enter, when the SUSPEND button is pressed.
S3 Video Report	-Disabled -Enabled	Set this value to allow video report support.

4-4-3. Advanced - CPU Configuration

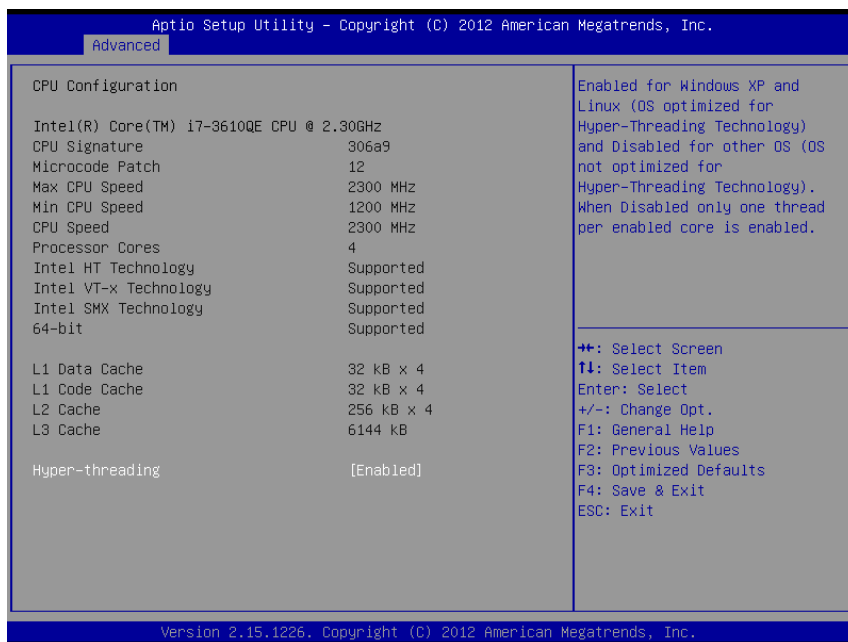

CPU Configuration Screen

BIOS Setting	Options	Description/Purpose
CPU Signature	no changeable options	CPU Signature
Microcode Patch	no changeable options	Microcode Patch
Max CPU Speed	no changeable options	Max CPU Speed
Min CPU Speed	no changeable options	Min CPU Speed
CPU speed	no changeable options	CPU speed
Processor Cores	no changeable options	Processor Cores
Intel HT Technology	no changeable options	Intel HT Technology
Intel VT-x Technology	no changeable options	Intel VT-x Technology
Intel SMX Technology	no changeable options	Intel SMX Technology
64-bit	no changeable options	Reports if processor supports Intel x86-64

BIOS Setting	Options	Description/Purpose
L1 Data Cache	no changeable options	L1 Data Cache
L1 Code Cache	no changeable options	L1 Code Cache
L2 Cache	no changeable options	L2 Cache
L3 Cache	no changeable options	L3 Cache
Hyper-Threading	-Disabled -Enabled	Enabled for Windows XP and Linux (OS optimized for Hyper-Threading Technology) and Disabled for other OS (OS not optimized for Hyper-Threading Technology). When Disabled, only one thread per enabled core is enabled.

4-4-4. Advanced – SATA Configuration

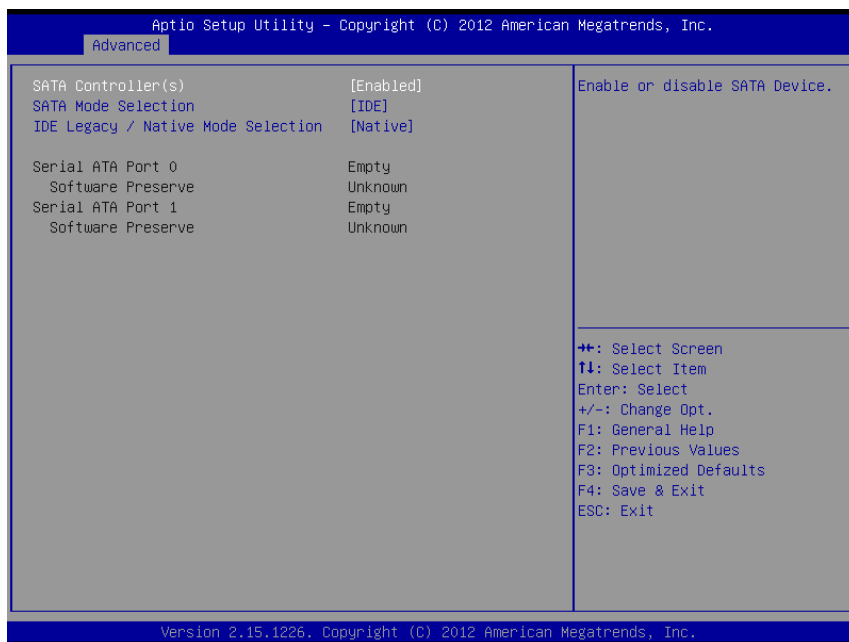

SATA Configuration Screen

BIOS Setting	Options	Description/Purpose
SATA Controller(s)	-Disabled -Enabled	Enable / Disable Serial ATA Controller.
SATA Mode Selection	-IDE -AHCI -RAID	SATA controller type selection, corresponding to three options: IDE, RAID and AHCI.
IDE Legacy / Native Mode Selection	-Native -Legacy	IDE mode selection
Serial ATA Port0	[drive]	Displays the drive installed on this SATA port. Shows [Empty] if no drive is installed.
Serial ATA Port1	[drive]	Displays the drive installed on this SATA port. Shows [Empty] if no drive is installed.

4-4-5. PCH-FW Configuration

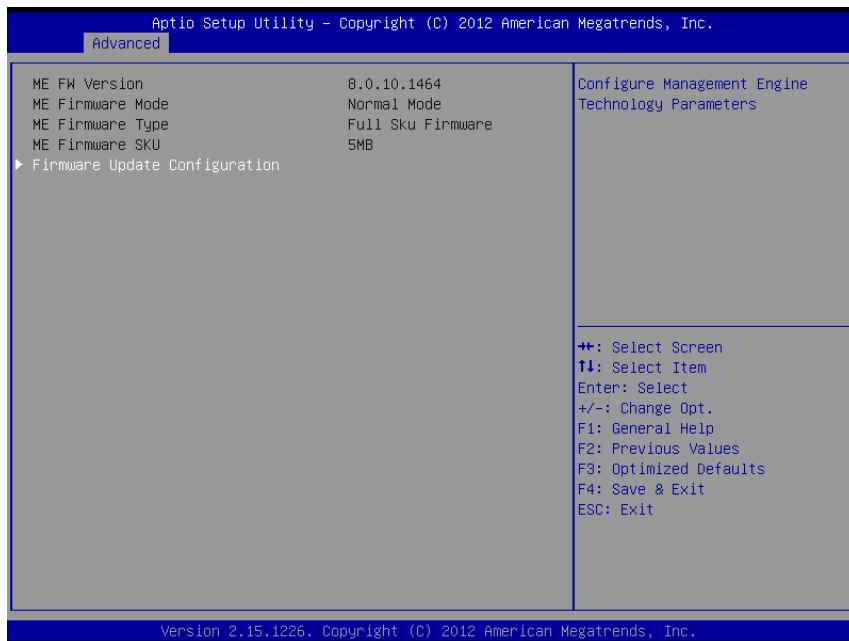

PCH-FW Configuration Screen

BIOS Setting	Options	Description/Purpose
ME FW Version	no changeable options	ME FW Version
ME Firmware Mode	no changeable options	ME Firmware Mode
ME Firmware Type	no changeable options	ME Firmware Type
ME Firmware SKU	no changeable options	ME Firmware SKU

4-4-5-1. PCH-FW Configuration – Firmware Update Configuration

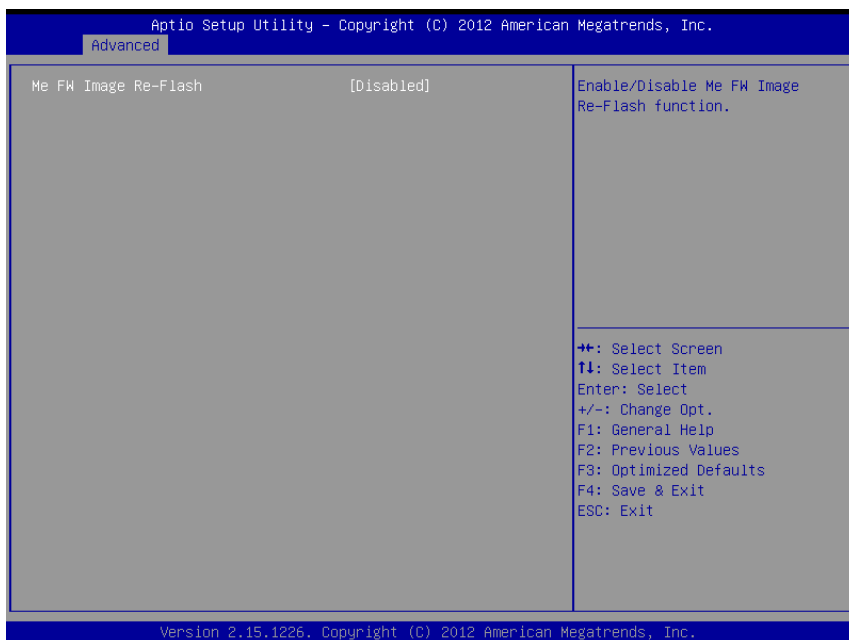

PCH-FW Configuration – Firmware Update Configuration Screen

BIOS Setting	Options	Description/Purpose
ME FW Image Re-Flash	-Disabled -Enabled	Use this item to enable or disable ME FW Image Re-Flash function.

4-4-6. Advanced – USB Configuration

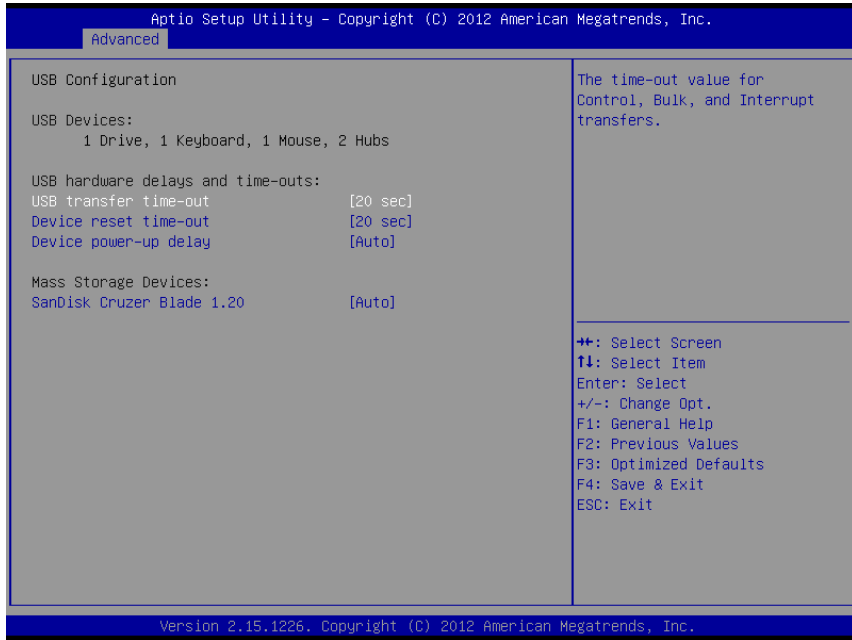

USB Configuration Screen

BIOS Setting	Options	Description/Purpose
USB Transfer time-out	-1 sec -5 sec -10 sec -20 sec	Use this item to set the time-out value for control, bulk, and interrupt transfers.
Device reset time-out	-10 sec -20 sec -30 sec -40 sec	Use this item to set USB mass storage device start unit command time-out.
Device power-up delay	-Auto -Manual	Use this item to set maximum time the device will take before it properly reports

4-4-7. Advanced – NCT6106 Super IO Configuration

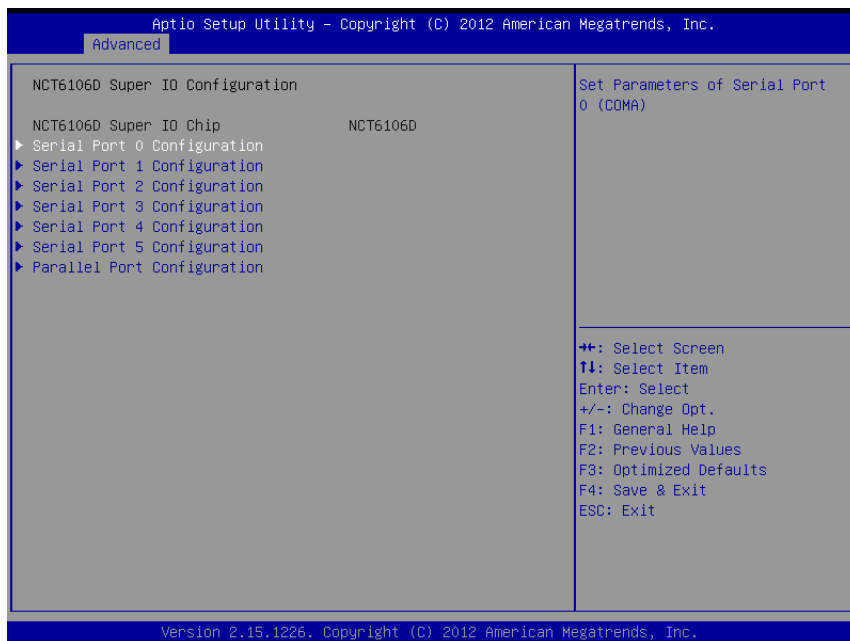

NCT6106 Super IO Configuration Screen

BIOS Setting	Options	Description/Purpose
Super IO Chip	No changeable options	Displays the super IO chip model.

4-4-7-1. Advanced – NCT6106 Super IO Configuration – Serial Port 0 Configuration

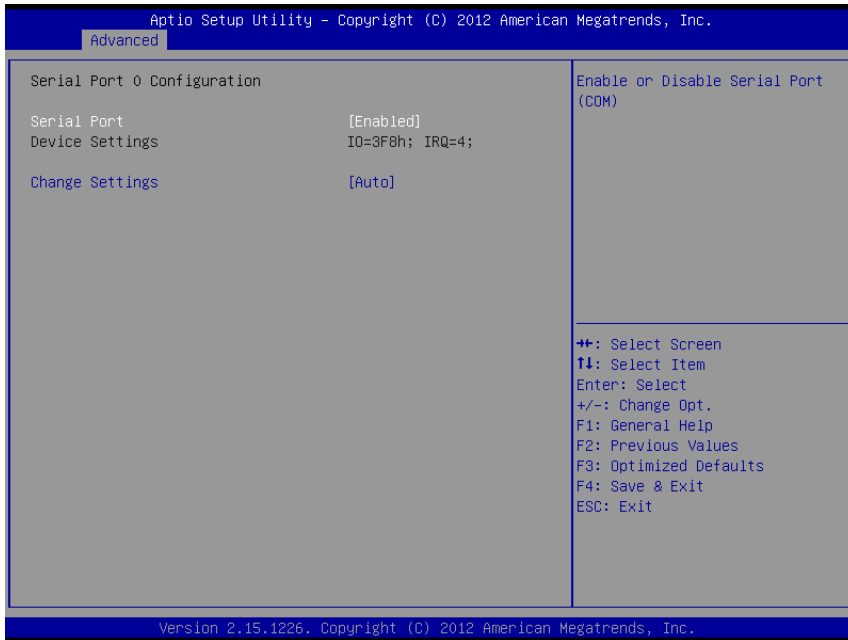

NCT6106 Super IO Configuration - Serial Port 0 Configuration Screen

BIOS Setting	Options	Description/Purpose
Serial Port	-Disabled -Enabled	Configures the serial port 0.
Device Settings	No changeable options	Reports the current serial port 0 setting.
Change Settings	-Auto -IO=3F8h; IRQ=4 -IO=3F8h; IRQ=3,4,5,6,7,10,11,12 -IO=2F8h; IRQ=3,4,5,6,7,10,11,12 -IO=3E8h; IRQ=3,4,5,6,7,10,11,12 -IO=2E8h; IRQ=3,4,5,6,7,10,11,12	Specifies the base I/O address and interrupt request for the serial port 0 if enabled.

4-4-7-2. Advanced – NCT6106 Super IO Configuration – Serial Port 1 Configuration



NCT6106 Super IO Configuration - Serial Port 1 Configuration Screen

BIOS Setting	Options	Description/Purpose
Serial Port	-Disabled -Enabled	Configures the serial port 1.
Device Settings	No changeable options	Reports the current serial port 1 setting.
Change Settings	-Auto -IO=2F8h; IRQ=3 -IO=3F8h; IRQ=3,4,5,6,7,10,11,12 -IO=2F8h; IRQ=3,4,5,6,7,10,11,12 -IO=3E8h; IRQ=3,4,5,6,7,10,11,12 -IO=2E8h; IRQ=3,4,5,6,7,10,11,12	Specifies the base I/O address and interrupt request for the serial port 1 if enabled.

4-4-7-3. Advanced – NCT6106 Super IO Configuration – Serial Port 2 Configuration

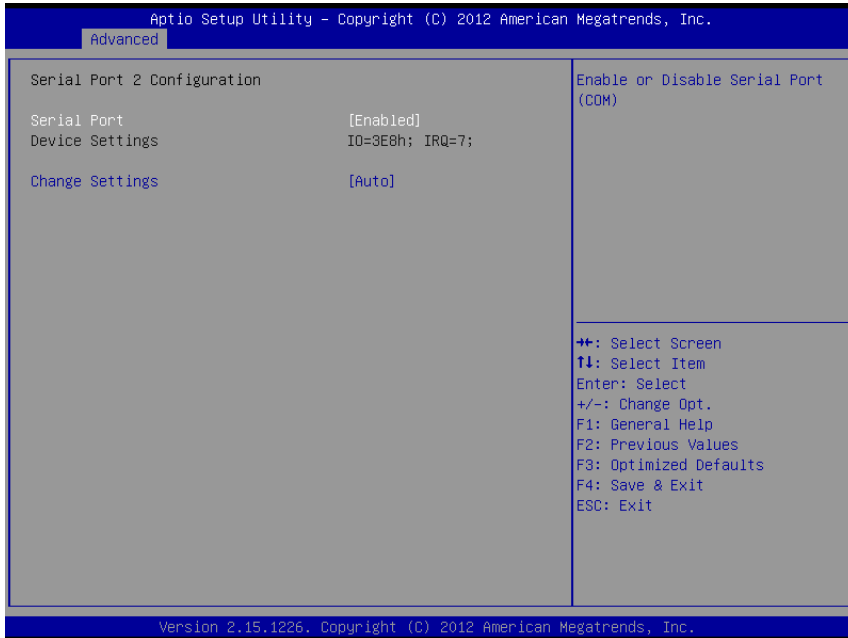

NCT6106 Super IO Configuration - Serial Port 2 Configuration Screen

BIOS Setting	Options	Description/Purpose
Serial Port	-Disabled -Enabled	Configures the serial port 2.
Device Settings	No changeable options	Reports the current serial port 2 setting.
Change Settings	-Auto -IO=3E8h; IRQ=7 -IO=3E8h; IRQ=3,4,5,6,7,10,11,12 -IO=2E8h; IRQ=3,4,5,6,7,10,11,12 -IO=2E0h; IRQ=3,4,5,6,7,10,11,12 -IO=2F0h; IRQ=3,4,5,6,7,10,11,12	Specifies the base I/O address and interrupt request for the serial port 2 if enabled.

4-4-7-4. Advanced – NCT6106 Super IO Configuration – Serial Port 3 Configuration



NCT6106 Super IO Configuration - Serial Port 3 Configuration Screen

BIOS Setting	Options	Description/Purpose
Serial Port	-Disabled -Enabled	Configures the serial port 3.
Device Settings	No changeable options	Reports the current serial port 3 setting.
Change Settings	-Auto -IO=2E8h; IRQ=7 -IO=3E8h; IRQ=3,4,5,6,7,10,11,12 -IO=2E8h; IRQ=3,4,5,6,7,10,11,12 -IO=2E0h; IRQ=3,4,5,6,7,10,11,12 -IO=2F0h; IRQ=3,4,5,6,7,10,11,12	Specifies the base I/O address and interrupt request for the serial port 3 if enabled.

4-4-7-5. Advanced – NCT6106 Super IO Configuration – Serial Port 4 Configuration

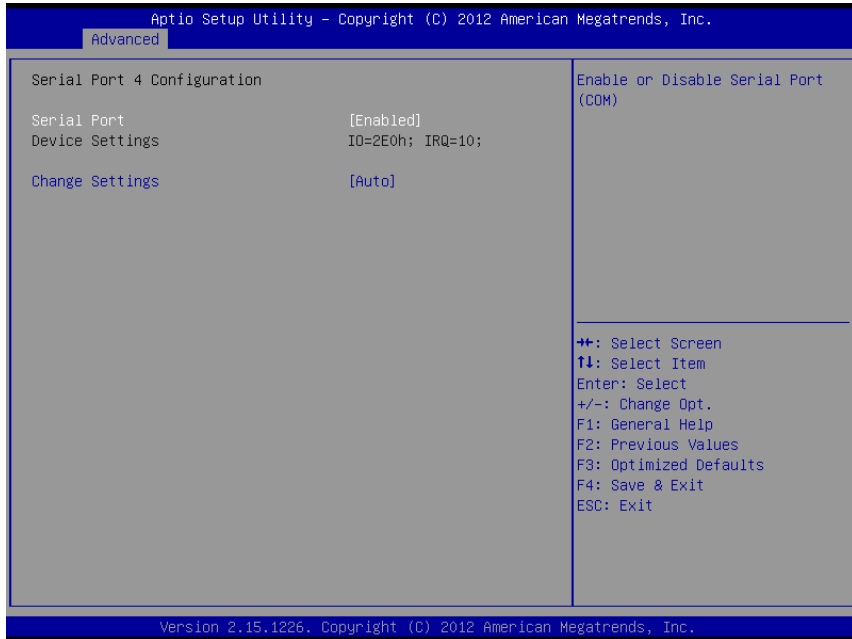

NCT6106 Super IO Configuration - Serial Port 4 Configuration Screen

BIOS Setting	Options	Description/Purpose
Serial Port	-Disabled -Enabled	Configures the serial port 4.
Device Settings	No changeable options	Reports the current serial port 4 setting.
Change Settings	-Auto -IO=2E0h; IRQ=10 -IO=3E8h; IRQ=3,4,5,6,7,10,11,12 -IO=2E8h; IRQ=3,4,5,6,7,10,11,12 -IO=2E0h; IRQ=3,4,5,6,7,10,11,12 -IO=2F0h; IRQ=3,4,5,6,7,10,11,12	Specifies the base I/O address and interrupt request for the serial port 4 if enabled.

4-4-7-6. Advanced – NCT6106 Super IO Configuration – Serial Port 5 Configuration

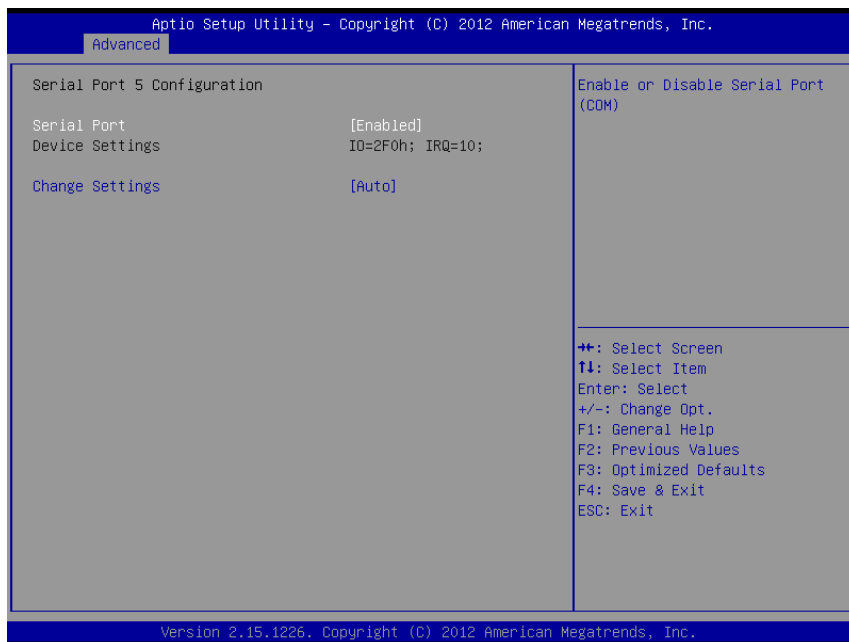

NCT6106 Super IO Configuration - Serial Port 5 Configuration Screen

BIOS Setting	Options	Description/Purpose
Serial Port	-Disabled -Enabled	Configures the serial port 5.
Device Settings	No changeable options	Reports the current serial port 5 setting.
Change Settings	-Auto -IO=2F0h; IRQ=10 -IO=3E8h; IRQ=3,4,5,6,7,10,11,12 -IO=2E8h; IRQ=3,4,5,6,7,10,11,12 -IO=2E0h; IRQ=3,4,5,6,7,10,11,12 -IO=2F0h; IRQ=3,4,5,6,7,10,11,12	Specifies the base I/O address and interrupt request for the serial port 5 if enabled.

4-4-7-7. Advanced – NCT6106 Super IO Configuration – Parallel Port Configuration

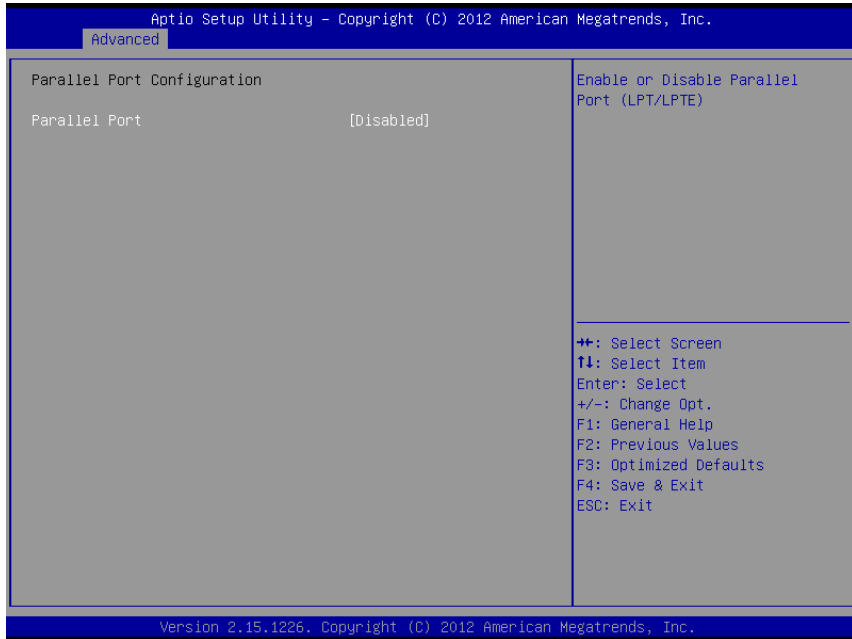

NCT6106 Super IO Configuration - Parallel Port Configuration Screen

BIOS Setting	Options	Description/Purpose
Parallel Port	-Disabled -Enabled	Configures the parallel port.
Change Settings	-Auto -IO=378h; IRQ=5 -IO=378h; IRQ=5,6,7,10,11,12 -IO=278h; IRQ=5,6,7,10,11,12 -IO=3BCh; IRQ=5,6,7,10,11,12	Specifies the base I/O address and interrupt request for the parallel port if enabled.
Device Mode	-STD Printer Mode -SPP Mode -EPP-1.9 and SPP Mode	Selects the mode for the parallel port. Not available if the parallel port is disabled.

BIOS Setting	Options	Description/Purpose
	-EPP-1.7 and SPP Mode -ECP -ECP and EPP 1.9 Mode -ECP and EPP 1.7 Mode	SPP is Standard Parallel Port mode, a bi-directional mode for printers. EPP is Enhanced Parallel Port mode, a high-speed bi-directional mode for non-printer peripherals. ECP is Enhanced Capability Port mode, a high-speed bi-directional mode for printers and scanners.

4-4-8. Advanced – NCT6106 HW Monitor

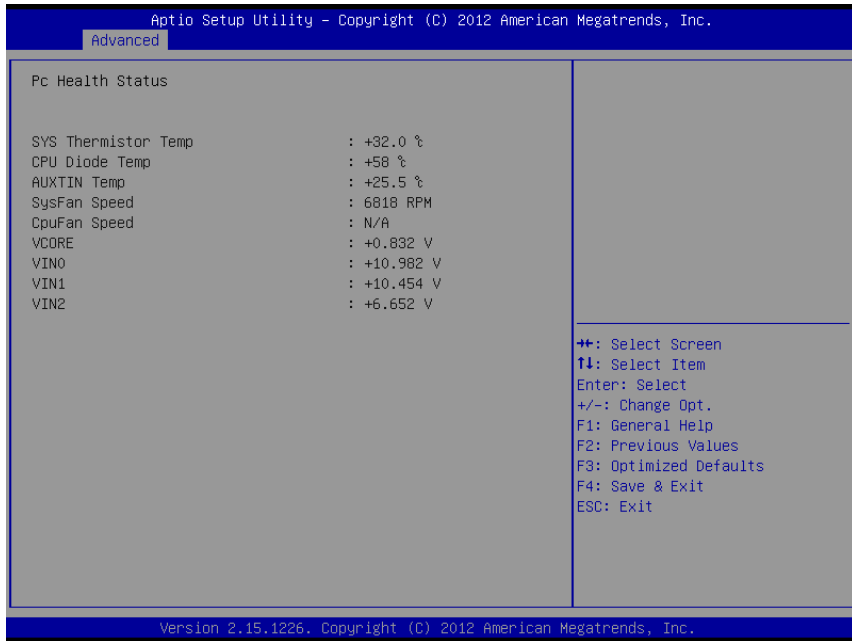

H/W Monitor Screen

BIOS Setting	Options	Description/Purpose
SYS Thermistor Temp	No changeable options	Display system temperature.
CPU Diode Temp	No changeable options	Display processor's temperature.
SysFan Speed	No changeable options	Display fan speed of the System fan.
CpuFan Speed	No changeable options	Display fan speed of the CPU fan.
VCORE	No changeable options	Display voltage level of the +VCORE in supply.
VIN0	No changeable options	Display voltage level of the VIN0 in supply.
VIN1	No changeable options	Display voltage level of the VIN0 in supply.
VIN2	No changeable options	Display voltage level of the VIN2 in supply.

4-4-9. Advanced – WatchDog Configuration

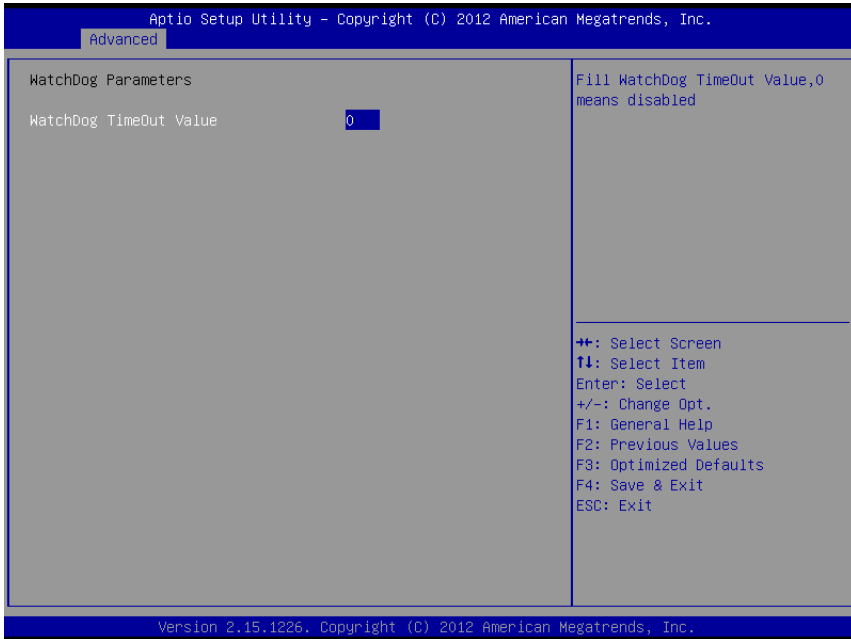

Watchdog Configuration Screen

BIOS Setting	Options	Description/Purpose
Watchdog timeout value	multiple options ranging from 0 to 255	Sets the desired value for watchdog timer. 0 means disabled.

4-5. Chipset

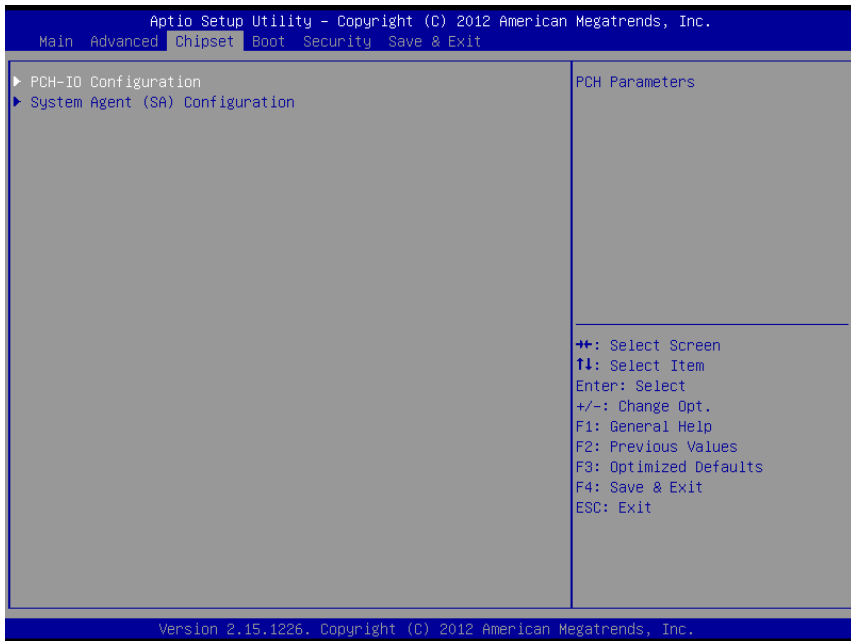

Chipset Screen

4-5-1. Chipset – PCH-IO Configuration

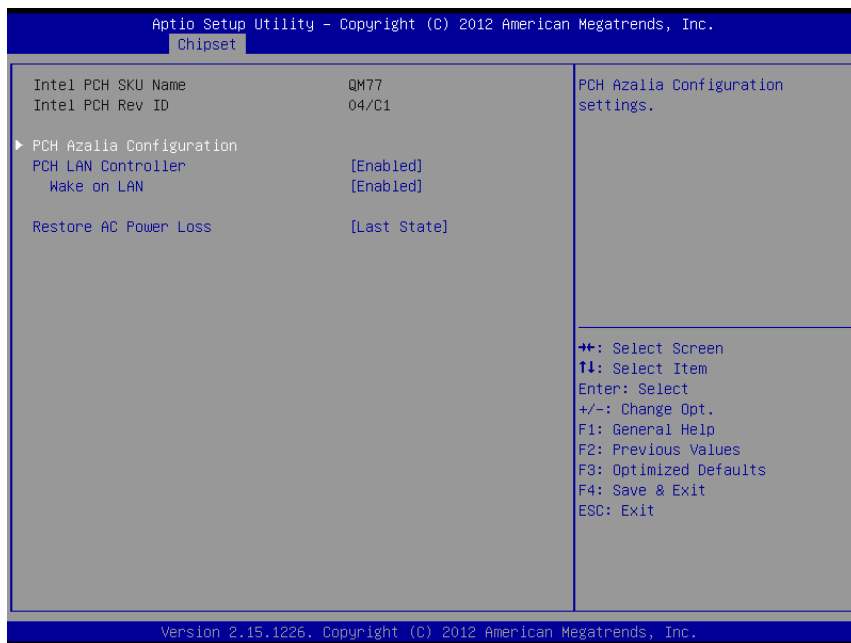

PCH-IO Configuration Screen

BIOS Setting	Options	Description/Purpose
Intel PCH SKU Name	No changeable options	Displays Intel PCH SKU Name.
Intel PCH Rev ID	No changeable options	Display Intel PCH Rev ID.
PCH LAN Controller	-Enabled -Disabled	Enable or disable onboard NIC.
Wake on LAN	-Enabled -Disabled	Enable or disable integrated LAN to wake the system.
Restore AC Power Loss	-Power Off -Power On -Last State	Use this item to select AC power state when power is re-applied after a power failure.

4-5-1-1. Chipset - PCH-IO Configuration – PCH Azalia Configuration

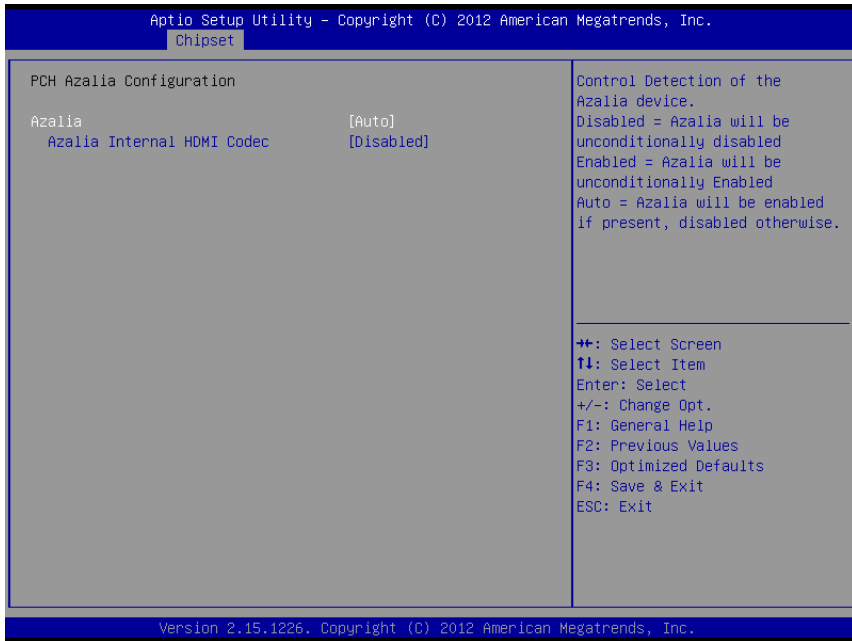

PCH-IO Configuration – PCH Azalia Configuration Screen

BIOS Setting	Options	Description/Purpose
Azalia	-Disabled -Enabled -Auto	The Audio Configuration settings Enable/Disable the Azalia HD Audio.
Azalia Internal HDMI Codec	-Disabled -Enabled	Use this item to enable or disable internal HDMI codec for Azalia.

4-5-2. Chipset – System Agent (SA) Configuration

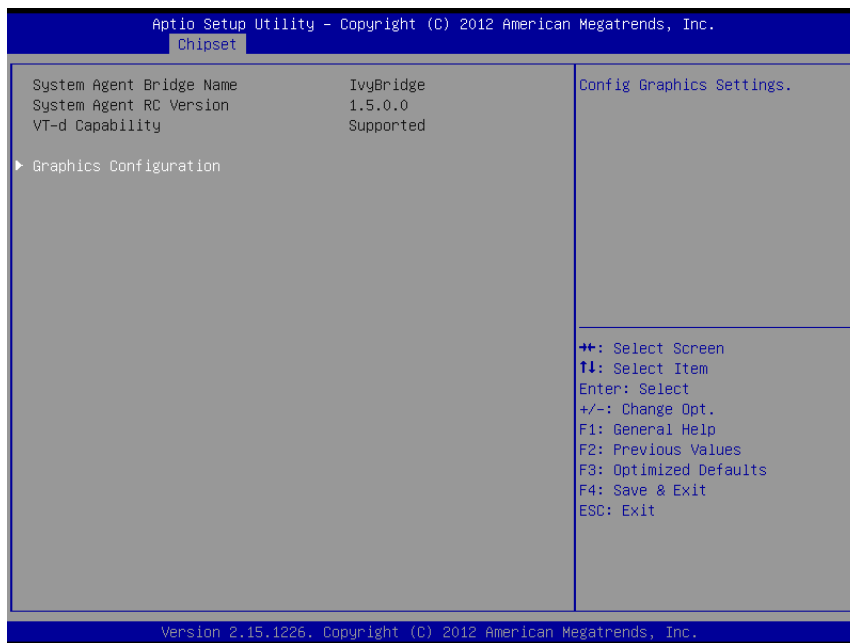

System Agent (SA) Configuration Screen

BIOS Setting	Options	Description/Purpose
System Agent Bridge Name	No changeable options	Displays System Agent Bridge Name.
System Agent RC Version	No changeable options	Display System Agent RC Version.
VT-d Capability	No changeable options	Display VT-d Capability.

4-5-2-1. Chipset – System Agent (SA) Configuration – Graphics Configuration

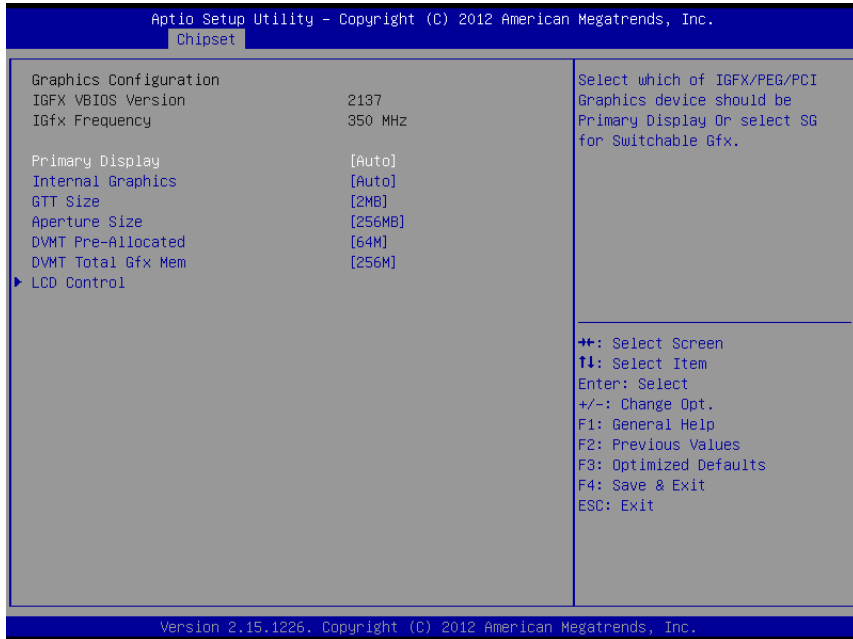

System Agent (SA) Configuration – Graphics Configuration Screen

BIOS Setting	Options	Description/Purpose
Primary Display	-Auto -IGFX -PEG -PCI -SG	Select which of IGFX/PEG/PCI graphics device should be primary display or select SG for switchable Gfx.
Internal Graphics	-Auto -Disabled -Enabled	Keep IGD enabled based on the setup options
GTT Size	-1MB -2MB	Select the GTT Size.
Aperture Size	-128MB -256MB -512MB	Select the Aperture Size.

BIOS Setting	Options	Description/Purpose
DVMT Pre-Allocated	-32MB -64MB -96MB -128MB -160MB -192MB -224MB -256MB -288MB -320MB -352MB -384MB -416MB -448MB -480MB -512MB -1024MB	Select DVMT 5.0 Pre-Allocated (Fixed) graphics memory size used by the internal graphics device.
DVMT Total Gfx Mem	-128MB -256MB -MAX	Select DVMT 5.0 total graphics memory size used by the internal graphics device.

4-5-2-2. Chipset – System Agent (SA) Configuration – Graphics Configuration – LCD Control

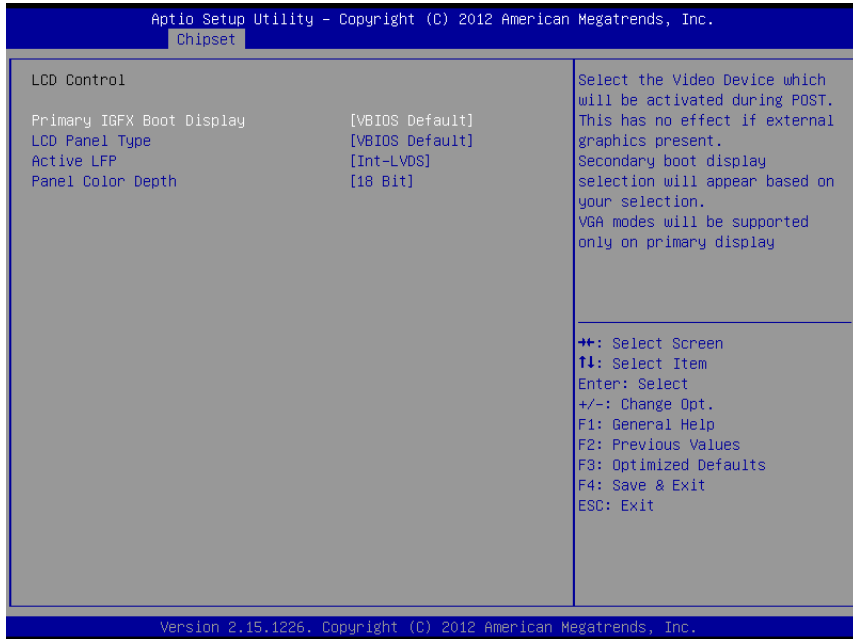

System Agent (SA) Configuration – Graphics Configuration – LCD Control Screen

BIOS Setting	Options	Description/Purpose
Primary IGFX Boot Display	-VBIOS Default -CRT -EFP -LFP -EFP3 -EFP2 -LFP2	Select the Video Device, which will be activated during POST. This has no effect if external graphics present. Secondary boot display selection will appear based on your selection. VGA modes will be supported only on primary display.
LCD Panel Type	-VBIOS Default -640x480 LVDS -800x600 LVDS -1024x768	Select LCD panel used by Internal Graphics Device by selecting the appropriate setup item.

BIOS Setting	Options	Description/Purpose
	LVDS1 -1280x1024 LVDS -1400x1050(RB) LVDS1 -1400x1050 LVDS2 -1600x1200 LVDS -1366x768 LVDS -1680x1050 LVDS -1920x1200 LVDS1 -1440x900 LVDS -1600x900 LVDS -1024x768 LVDS2 -1280x800 LVDS -1920x1080 LVDS -2048x1536 LVDS	
Active LFP	-No LVDS -Int-LVDS	Select the Active LFP Configuration. No LVDS: VBIOS does not enable LVDS. Int-LVDS: VBIOS enables LVDS driver by Integrated encoder. SDVO LVDS: VBIOS enables LVDS driver by SDVO encoder. eDP Port-A: LFP Driven by Int-DisplayPort encoder from Port-A.
Panel Color Depth	- 18 Bit - 24 Bit	Select the LFP Panel Color Depth.

4-6. Boot

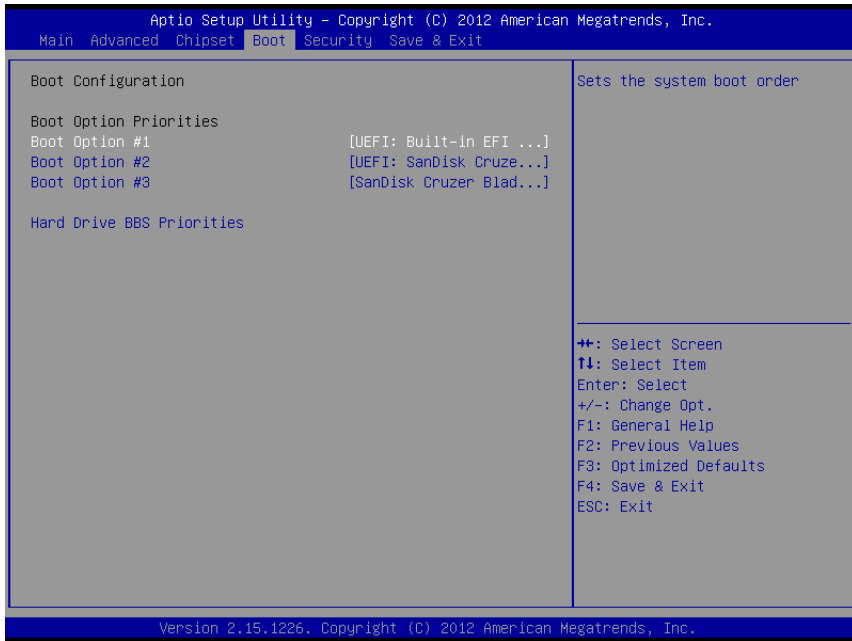

Boot Screen

BIOS Setting	Options	Description/Purpose
Boot Option #1	-[drive(s)] -Disabled	Allows to set boot option listed in Hard Drive BBS Priorities.

4-7. Security



Security Screen

BIOS Setting	Options	Description/Purpose
Administrator Password	Password can be up to 20 alphanumeric characters.	Specifies the administrator password.
User Password	Password can be up to 20 alphanumeric characters.	Specifies the user password.

4-8. Save & Exit

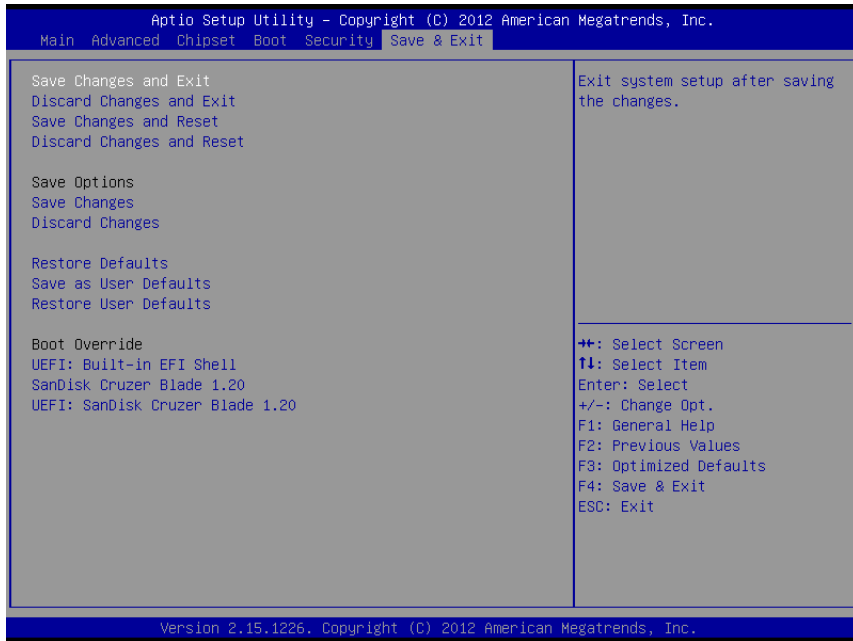

Save & Exit Screen

BIOS Setting	Options	Description/Purpose
Save Changes and Exit	No changeable options	Exits and saves the changes in CMOS SRAM.
Discard Changes and Exit	No changeable options	Exits without saving any changes made in BIOS settings.
Save Changes and Reset	No changeable options	Saves the changes in CMOS SRAM and resets.
Discard Changes and Reset	No changeable options	Resets without saving any changes made in BIOS settings.
Save Changes	No changeable options	Saves the changes done in BIOS settings so far.
Discard Changes	No changeable options	Discards the changes done in BIOS settings so far.
Restore Defaults	No changeable options	Loads the optimized defaults for BIOS settings.

BIOS Setting	Options	Description/Purpose
Save as User Defaults	No changeable options	Saves the current values as user defaults.
Restore User Defaults	No changeable options	Loads the user defaults for BIOS settings.
Boot Override	-[drive(s)]	Forces to boot from selected [drive(s)].

SYSTEM ASSEMBLY

APPENDIX

A

This appendix contains the exploded diagram of the system.

Section includes:

- Exploded Diagram for Basic Construction
- Exploded Diagram for Front Panel
- Exploded Diagram for Mainboard
- Exploded Diagram for Heatsink Cover
- Exploded Diagram for HDD

EXPLODED DIAGRAM FOR BASIC CONSTRUCTION

SP-6205/6207/6209

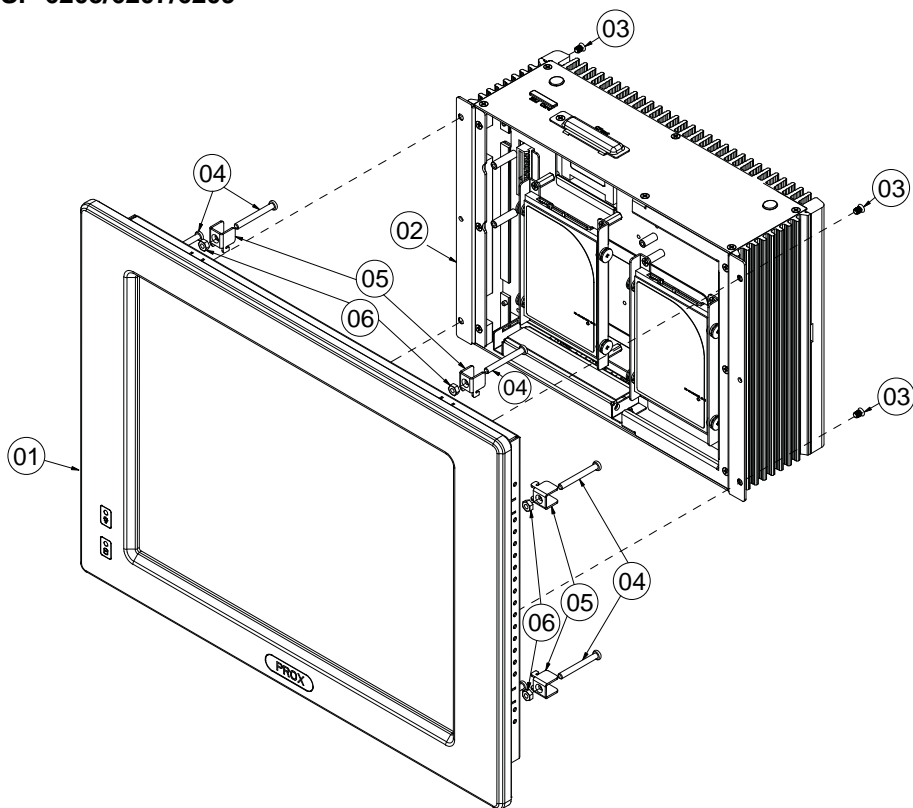

No.	COMPONENT NAME	PART No.	Q`TY
1	15-LCD_FOR-LMI50X8_FOR6205_EXP	--	1
	15-LCD_FOR-LMI50X8_FOR6207_EXP	--	
	15-LCD_FOR-LMI50X8_FOR6209_EXP	--	
2	SE-8210_ASSY_EXP	--	1
3	FLAT HEAD SCREW M4x0.7Px6mm(Black)	22-215-40006011	4
4	ROUND HEAD SCREW M4x0.7Px35mm	22-232-30035011	8
5	M4 HOOK	20-011-02001009	8
6	HEX NUTS M4x0.7P, H=3mm	23-102-40300071	8

SP-6208

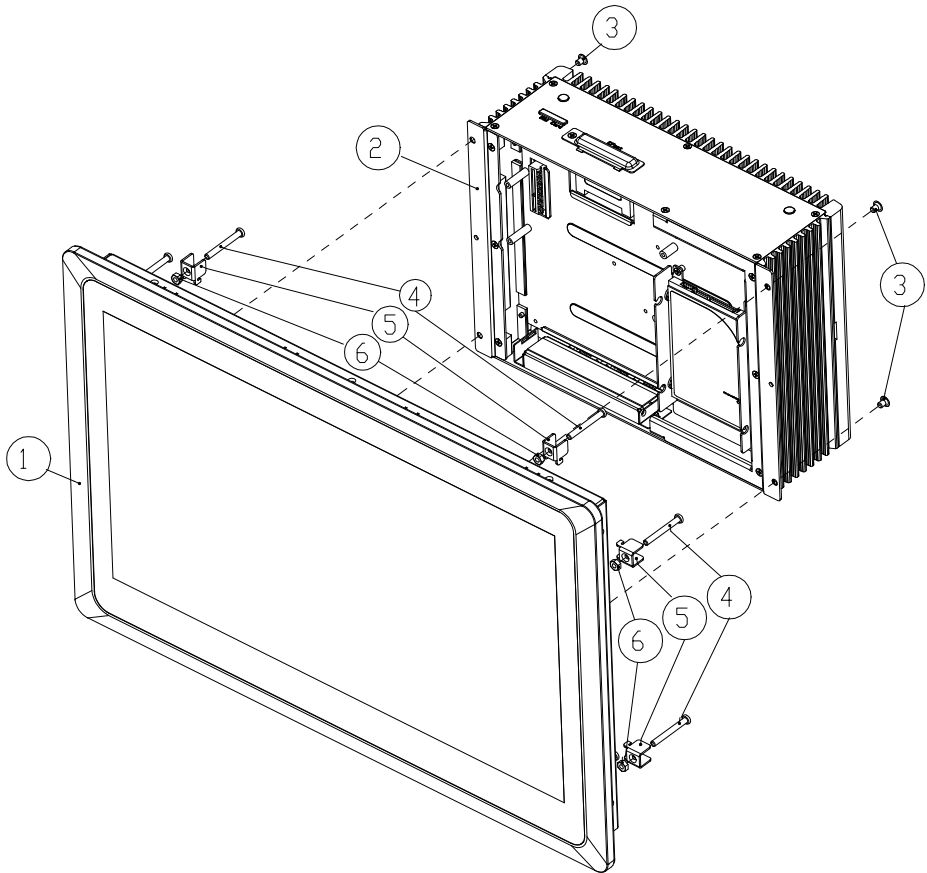

Item	Part Name	Part Number	Q'ty
1	6208-LCD_ASSY_EXP		1
2	SE-8210_ASSY_EXP		1
3	FLAT HEAD SCREW/M4x0.7Px6mm	22-215-40006011	4
4	ROUND HEAD SCREW/M4x0.7Px35mm	22-232-30035011	8
5	M4 Hook	20-011-02001009	8
6	HEX NUTS(M4x0.7P,H=3mm)	23-102-40300071	8

EXPLODED DIAGRAM FOR FRONT PANEL

SP-6205

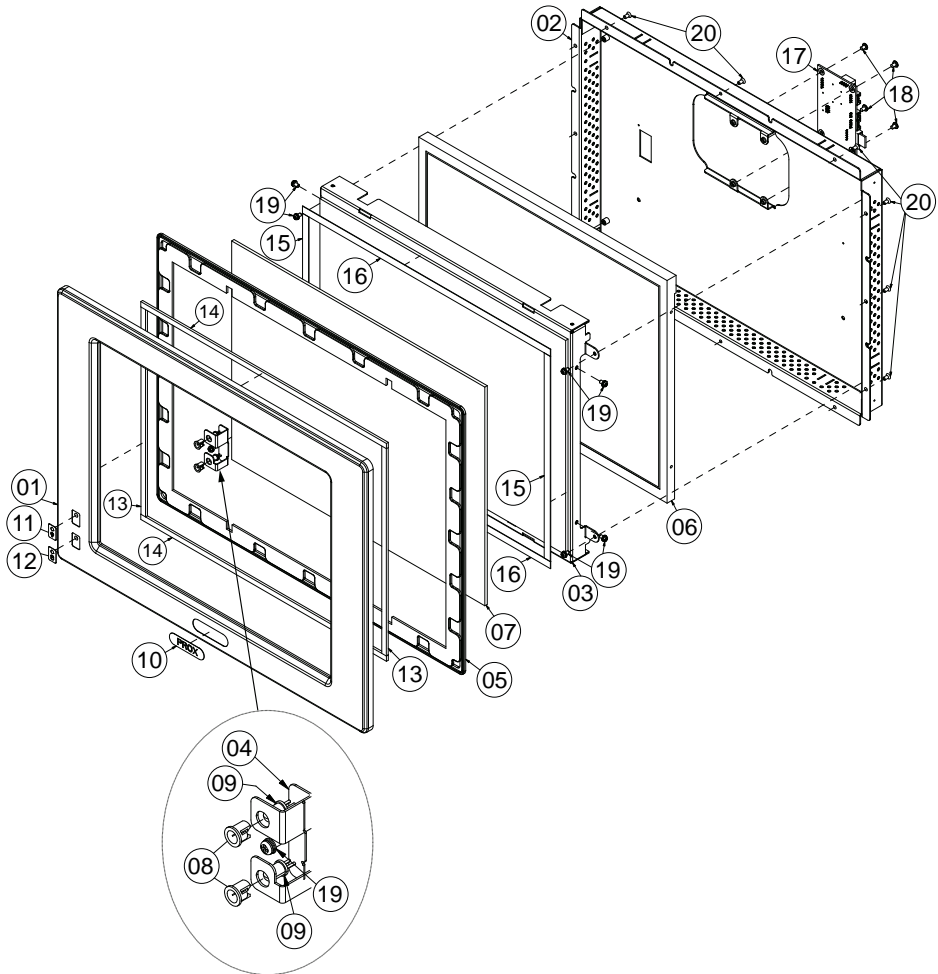

No.	COMPONENT NAME	PART No.	Q`TY
1	SP-6205 FRONT PANEL(w/Paint)(Black)	20-003-01061271	1
2	SP-6205 15 LCD COVER(w/Paint)(Black)	20-004-03062271	1
3	SP-6205 15-LMI50x8 HOLDER	80-029-03001271	1
4	SP-6205 LED SUPPORT2	80-002-03001271	1
5	SP-6205 WALL WATERPROOF	90-013-01100271	1
6	LCD SCREEN	xx-xxx-xxxxxxxxxx	1
7	TOUCH PANEL	--	1
8	LED HOUSING(Black)	30-014-04100009	2
9	SP-6205 POWER & HDD LED CABLE L=360mm(GREEN&RED)LED CABLE	27-018-27108111	1
10	FLAT LABEL FOR PORXLABEL	34-017-02104009	1
11	PPC-7360 LED LABEL FOR POWERLABEL	34-017-02103009	1
12	LED LABEL FOR HDDLABEL	34-017-02101009	1
13	TOUCH_PANEL_EVA_3V(236x6x3mm Black)	90-013-15100271	2
14	TOUCH_PANEL_EVA_3L(323x6x3mm Black)	90-013-15200271	2
15	TOUCH_PANEL_PRON_0_5V(233.5x8x0.5mm Black)	90-013-24100271	2
16	TOUCH_PANEL_PRON_0_5L(326x8x0.5mm Black)	90-013-24200271	2
17	PAC8100LF_PCB	--	1
18	FILLISTR HEAD SCREW #2/M3x0.5Px4mm	82-272-30004018	4
19	ROUND HEAD WITH SPRING WASHER SCREW M3x0.5Px6mm	22-232-30060211	8
20	FLAT HEAD SCREW #2/φ5/M3x0.5Px6mm(Black)	22-215-30006311	12

SP-6207

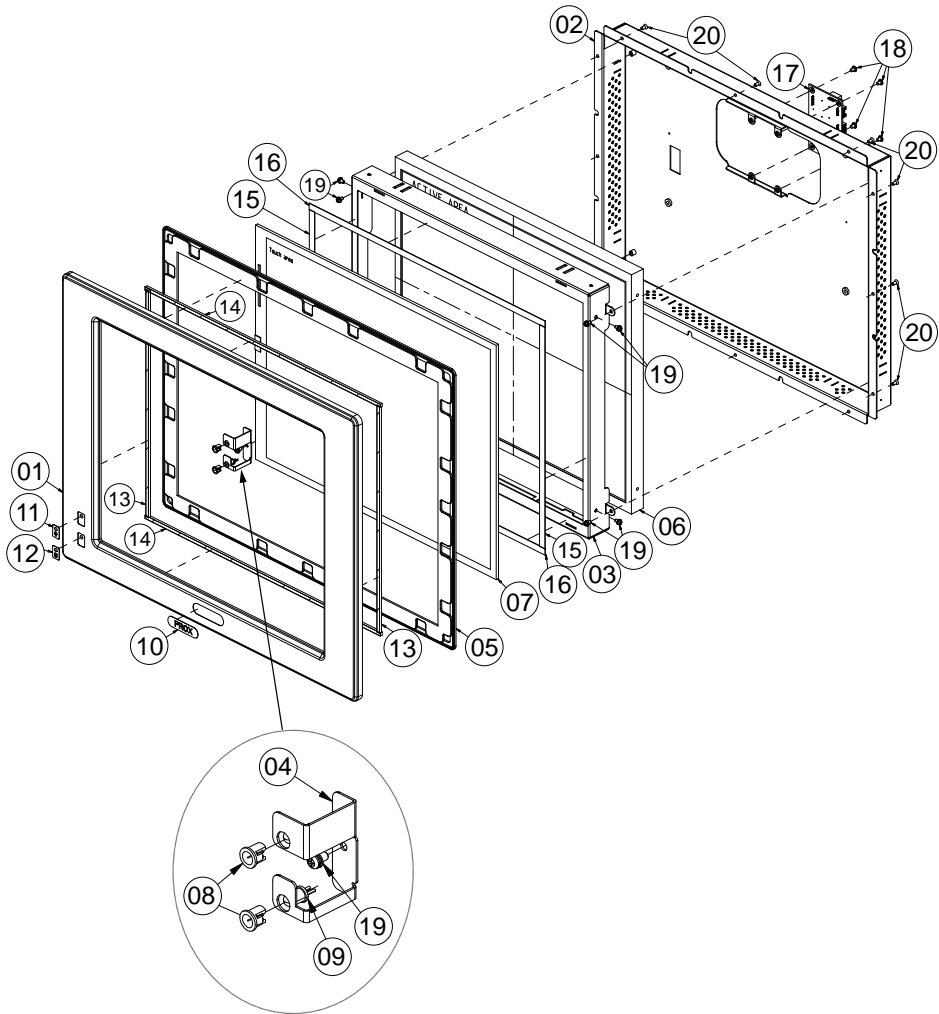

No.	COMPONENT NAME	PART No.	Q`TY
1	SP-6207 17 NEW FRONT PANEL	20-003-01091276	1
2	SP-6207 LCD COVER(w/Paint)(Black)	20-029-03061276	1
3	SP-6207 17 AU HOLDER	80-029-03001276	1
4	SP-6207 LED SUPPORT FOR 17	80-002-03001276	1
5	WALL_WATERPROOF_FOR_SP6205:RUBBER(Black)	xx-xxx-xxxxxxxxxx	1
6	17 Inch LCD	xx-xxx-xxxxxxxxxx	1
7	17 Inch TOUCH	--	1
8	LED HOUSING(Black)	30-014-04100009	2
9	SP-6207 LED CABLE	--	1
10	FLAT LABEL FOR PORX	34-017-02104009	1
11	PPC-7360 LED LABEL FOR POWER	34-017-02103009	1
12	LED LABEL FOR HDD	34-017-02101009	1
13	SP-6207 TOUCH THIN GAP SPONGE V(281.2x4x3mm)	90-013-24100276	2
14	SP-6207 TOUCH THIN GAP SPONGE H(357x4x3mm)	90-013-24200276	2
15	PT-1770 PORON SPONGE V(275x8x0.5mm)	90-013-24100255	2
16	SP-6207 TOUCH PANEL PORON 0.5L(358x8x0.5mm)	90-013-24300276	2
17	PAC8100LF_PCB	--	1
18	FILLISTR HEAD SCREW #2/M3x0.5Px4mm	82-272-30004018	4
19	ROUND HEAD WITH SPRING WASHER SCREW M3x0.5Px6mm	22-232-30060211	8
20	FLAT HEAD SCREW #2/φ5/M3x0.5Px6mm(Black)	22-215-30006311	12

SP-6208

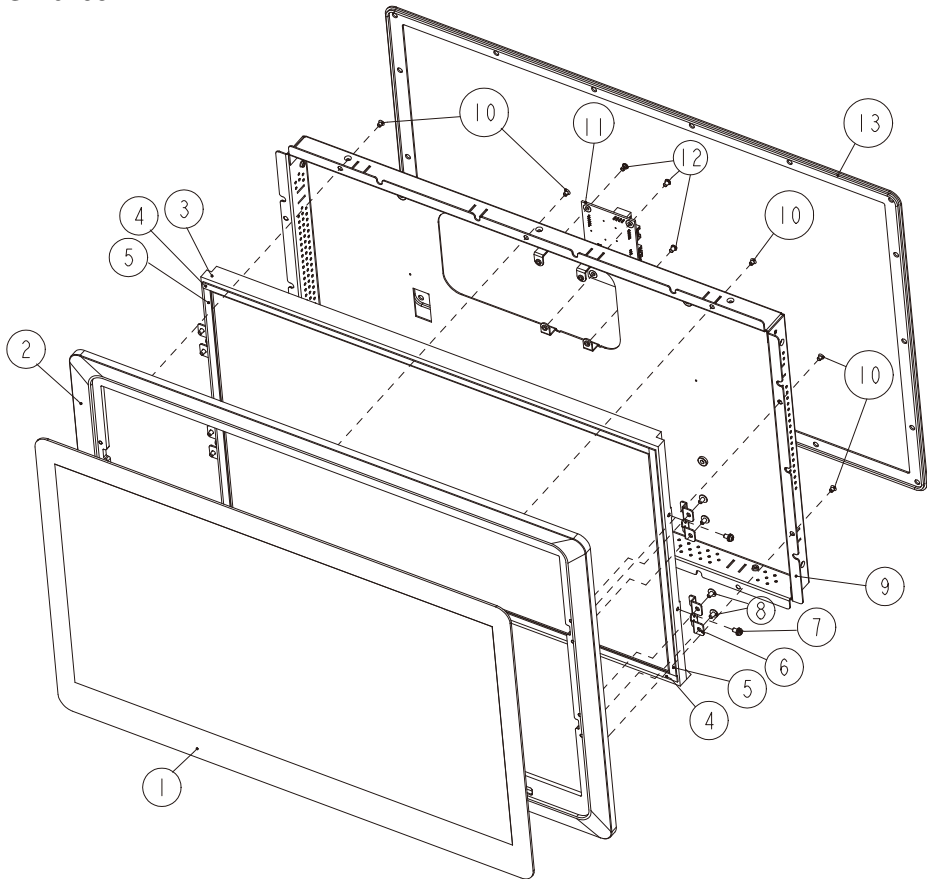

Appendix A System Assembly

Item	Part Name	Part Number	Qty
1	18.5" Capacitive Multi-Touch Panel	52-380-15018517	1
2	FRONT FRAME	20-007-01091331	1
3	18.5" TFT LCD Panel(LED Backlight)	52-351-14850102	1
4	SP-6208 PORON T B(420x6x1mm)	30-013-24100331	2
5	SP-6208 PORON R L(240x6x1mm)	30-013-24200331	2
6	LCD HOLDER	20-029-03001331	4
7	ROUND HEAD WITH SPRING WASHER SCREW/M3x0.5Px6mm	22-232-30060211	4
8	ROUND WASHER HEAD SCREW/M3x0.5Px5mm	22-242-30005311	8
9	LCD COVER	20-004-03061331	1
10	FLAT HEAD SCREW/M3x0.5Px4mm(Black)	22-215-30004011	10
11	PAC8100LF_PCB		1
12	FILLISTR HEAD SCREW/M3x0.5Px4mm	82-272-30004018	4
13	SP-6208 OUT SIDE RUBBER	30-013-01100331	1

SP-6209

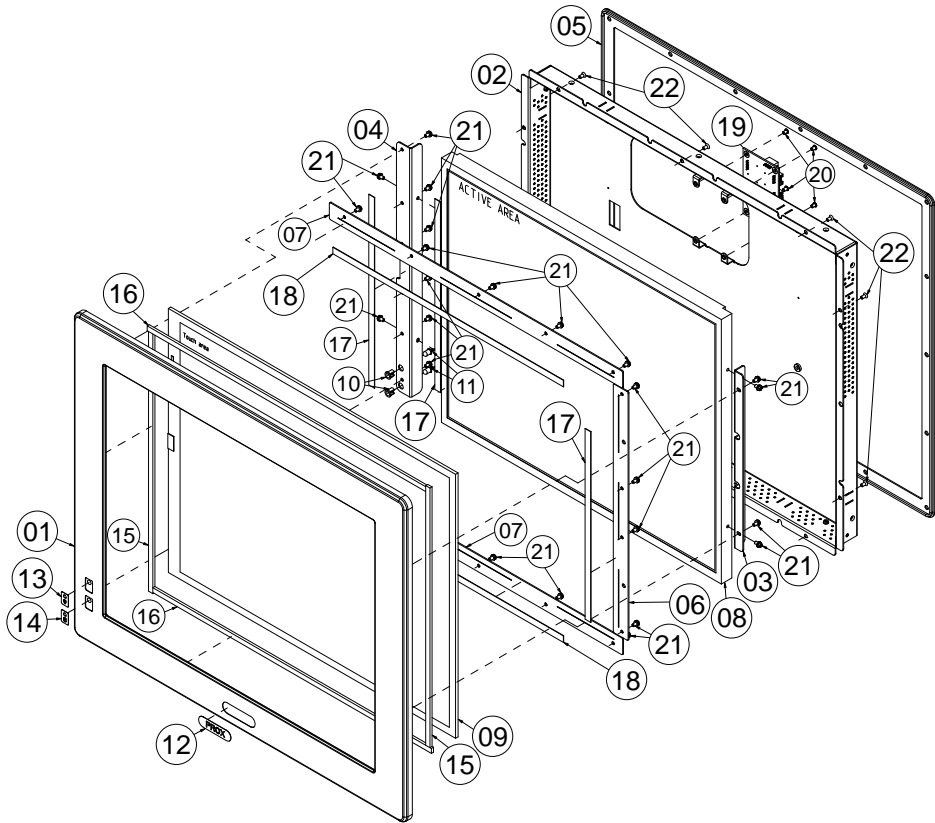

No.	COMPONENT NAME	PART No.	Q`TY
1	SP-6209 19 FRONT PANEL (Black)	20-003-01091279	1
2	SP-6209 LCD COVER(w/Paint)(Black)	20-004-03061279	1
3	SP-6209 LCD HOLDER R	80-029-03002279	1
4	SP-6209 LCD HOLDER L	80-029-03001279	1
5	WALL_WATERPROOF_FOR_SP6209;RUBBER(Black)	xx-xxx-xxxxxxxxxx	1
6	SP-6209 19 TOUCH SHEET	80-004-03001279	1
7	SP-6209 19 TOUCH SHEET 2	80-004-03002279	2
8	19 Inch LCD	xx-xxx-xxxxxxxxxx	1
9	19 Inch TOUCH	--	1
10	LED HOUSING (Black)	30-014-04100009	2
11	LED CABLE	--	1
12	FLAT LABEL FOR PORX	34-017-02104009	1
13	PPC-7360 LED LABEL FOR POWER	34-017-02103009	1
14	LED LABEL FOR HDD	34-017-02101009	1
15	SP-6209 PORON SPONGE (318x6x3mm)	90-013-24100279	2
16	SP-6209 PORON SPONGE (394x6x3mm)	90-013-24200279	2
17	SP-6209 TOUCH PANEL PORON 0.5V(304.5x8x0.5mm)	90-013-24300279	3
18	SP-6209 TOUCH PANEL PORON 0.5L(415x8x0.5mm)	90-013-24400279	2
19	PAC8100LF_PCB	--	1
20	FILLISTR HEAD SCREW #2/M3x0.5Px4mm	82-272-30004018	4
21	ROUND HEAD WITH SPRING WASHER SCREW M3x0.5Px6mm	22-232-30060211	26
22	FLAT HEAD SCREW #2/φ5/M3x0.5Px6mm(Black)	22-215-30006311	10

EXPLODED DIAGRAM FOR MAINBOARD

SP-6205/6207/6209

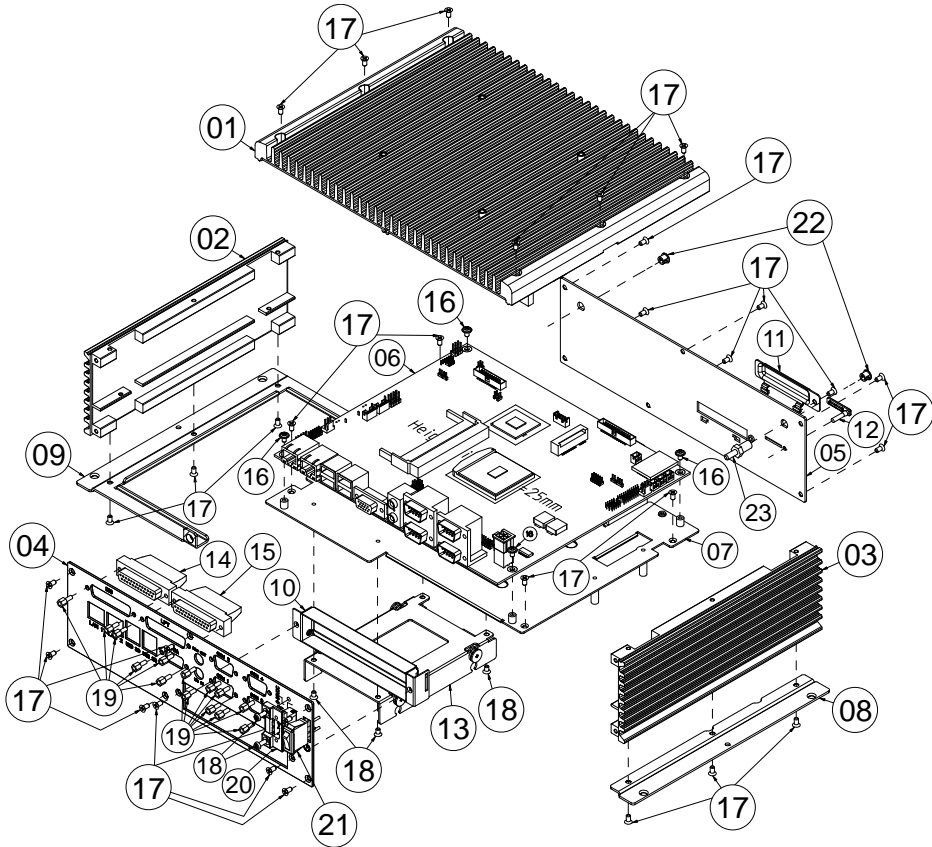

No.	COMPONENT NAME	PART No.	Q'TY
1	HEATSINK_TOP_COVER_ASSY_EXP	--	1
2	HEATSINK_LEFT_COVER:AL	21-002-10071002	1
3	HEATSINK_RIGHT_COVER:AL	21-002-10071001	1
4	SP-6205/6207/6209 FRONT IO BRACKET(w/Paint)(Black)	20-006-01061271	1
5	SP-6205/6207/6209 REAR IO BRACKET(w/Paint)(Black)	20-006-01063271	1
6	SE-8210_PCB_ASSY	--	1
7	BASE_BRACKET:SECC 1.2mm	20-006-03001261	1
8	SP-6205/6207/6209 BOTTOM BRACKET RIGHT(w/Paint)(Black)	20-006-03062271	1
9	SP-6205/6207/6209 BOTTOM BRACKET LEFT(w/Paint)(Black)	20-006-03061271	1
10	SLOT_BRACKET_14:SECC 0.8mm (Black)	20-006-03005261	1
11	SP-6205/6207/6209 CF COVER(w/Paint)(Black)	20-004-03061271	1
12	SIMCARD_Rubber_Cover:Rubber (Black)	30-013-01200261	1
13	HDD25_BRACKET_ASSY_EXP	--	1
14	DIO CABLE L=180mm(Attach Screw)	27-035-27104031	1
15	LPT CABLE L=220mm(Attach Screw)	27-004-27105031	1
16	ROUND WASHER HEAD SCREW M3x0.5Px5mm	22-242-30005311	4
17	FLAT HEAD SCREW #2/#5/M3x0.5Px6mm(Black)	22-215-30006311	35
18	PAN HEAD SCREW M3x0.5Px8mm	22-232-30008811	2
19	HEX CU BOSS UNC No. 4-40, L=4.8, H=7mm	22-692-40048051	14
20	SP-6205/6207 POWER CABLE (DC-IN) L=60mm	27-012-27102071	1
21	SP-6205 POWER SWITCH CABLE L=200mm	27-019-27104071	1
22	HOLE PLUG(Φ6.3~6.5mm)(Black)	30-054-04100000	2

SP-6208

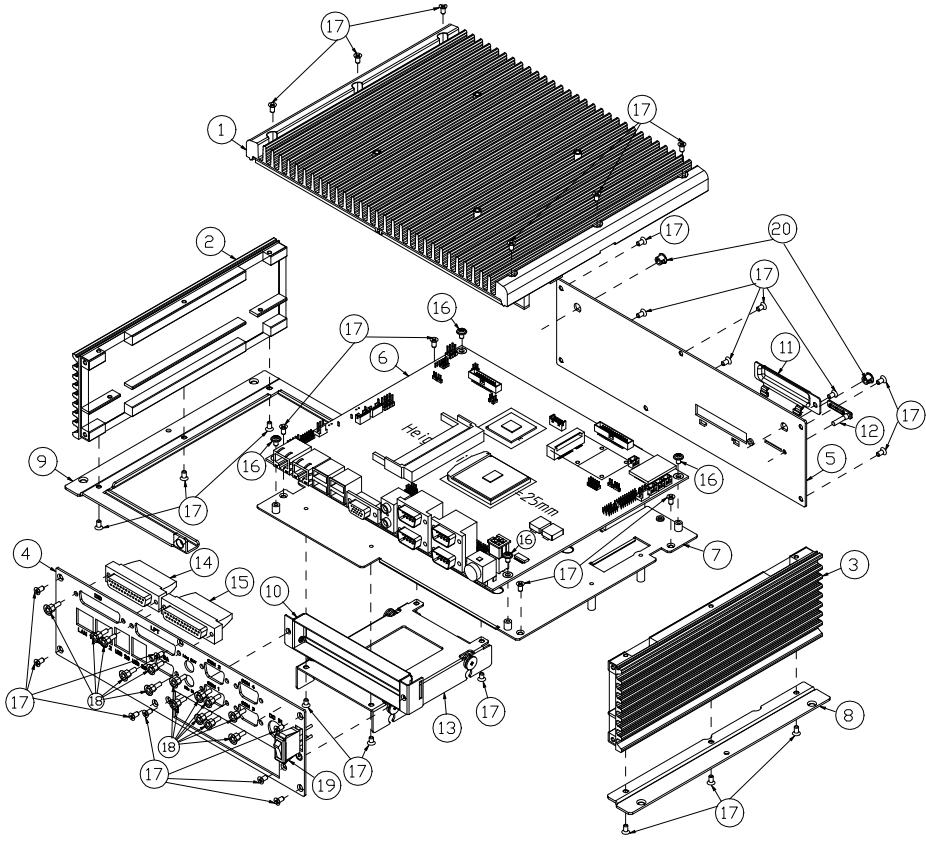

ITEM	COMPONENT NAME	PART No.	Q'TY
1	HEATSINK_TOP_COVER_ASSY_EXP		1
2	HEATSINK_LEFT_COVER ;AL	21-002-10071002	1
3	HEATSINK_RIGHT_COVER ;AL	21-002-10071001	1
4	SP-6205/6207/6209 FRONT IO BRACKET(w/Paint)(Black)	20-006-01061271	1
5	SP-6205/6207/6209 REAR IO BRACKET(w/Paint)(Black)	20-006-01063271	1
6	SE-8210_PCB_ASSY		1
7	BASE_BRACKET ;SECC 1.2mm	20-006-03001261	1
8	SP-6205/6207/6209 BOTTOM BRACKET RIGHT(w/Paint)(Black)	20-006-03062271	1
9	SP-6205/6207/6209 BOTTOM BRACKET LEFT(w/Paint)(Black)	20-006-03061271	1
10	SLOT_BRACKET_14 ;SECC 0.8mm (Black)	20-006-03005261	1
11	SP-6205/6207/6209 CF COVER(w/Paint)(Black)	20-004-03061271	1
12	SIMCARD_Rubber_Cover ;Rubber (Black)	30-013-01200261	1
13	HDD25_BRACKET_ASSY_EXP		1
14	DIO CABLE L=180mm(Attach Screw)	27-035-27104031	1
15	LPT CABLE L=220mm(Attach Screw)	27-004-27105031	1
16	ROUND WASHER HEAD SCREW M3x0.5Px5mm	22-242-30005311	4
17	FLAT HEAD SCREW #2/ψ5/M3x0.5Px6mm(Black)	22-215-30006311	35
18	HEX CU BOSS UNC No.4-40,L=4.8,H=7mm	22-692-40048051	14
19	SP-6205 POWER SWITCH CABLE L=200mm	27-019-27104071	1
20	HOLE PLUG(Φ6.3~6.5mm)(Black)	30-054-04100000	2
	2.4G 5DB Swivel Antenna With RSMA L=165mm(Black)	52-810-53160103	2
	J-Cable JC RP SMA J-137(B)IPEX L=250mm	27-043-16805001	2

EXPLODED DIAGRAM FOR HEATSINK COVER

SP-6205/6207/6209

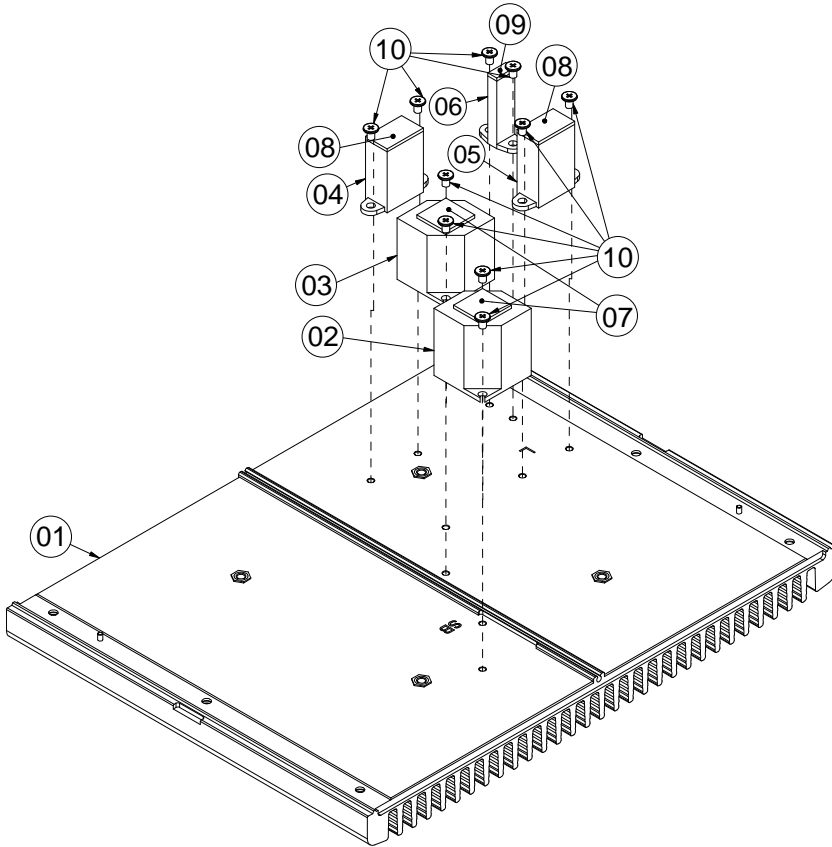

No.	COMPONENT NAME	PART No.	Q'TY
1	HEATSINK_TOP_COVER:AL	21-002-16000002	1
2	HEATSINK_BLOCK_SOUTHBRIDGE:AL	21-002-10000504	1
3	HEATSINK_BLOCK_CPU:CU	21-002-10000505	1
4	HEATSINK_BLOCK_INDUCTOR_H:AL	21-002-10000502	1
5	HEATSINK_BLOCK_INDUCTOR_L:AL	21-002-10000503	1
6	HEATSINK_BLOCK_CONTROLLER:AL	21-002-10000501	1
7	THERMAL INTERFACE PADS,16x16x1.5mm	81-006-81616001	2
8	THERMAL INTERFACE PADS,20x12x1.5mm	81-006-82012001	2
9	THERMAL INTERFACE PADS,10x5x1.5mm	81-006-81005001	1
10	FILLISTR HEAD SCREW #2/M3x0.5Px4mm	82-272-30004018	10

SP-6208

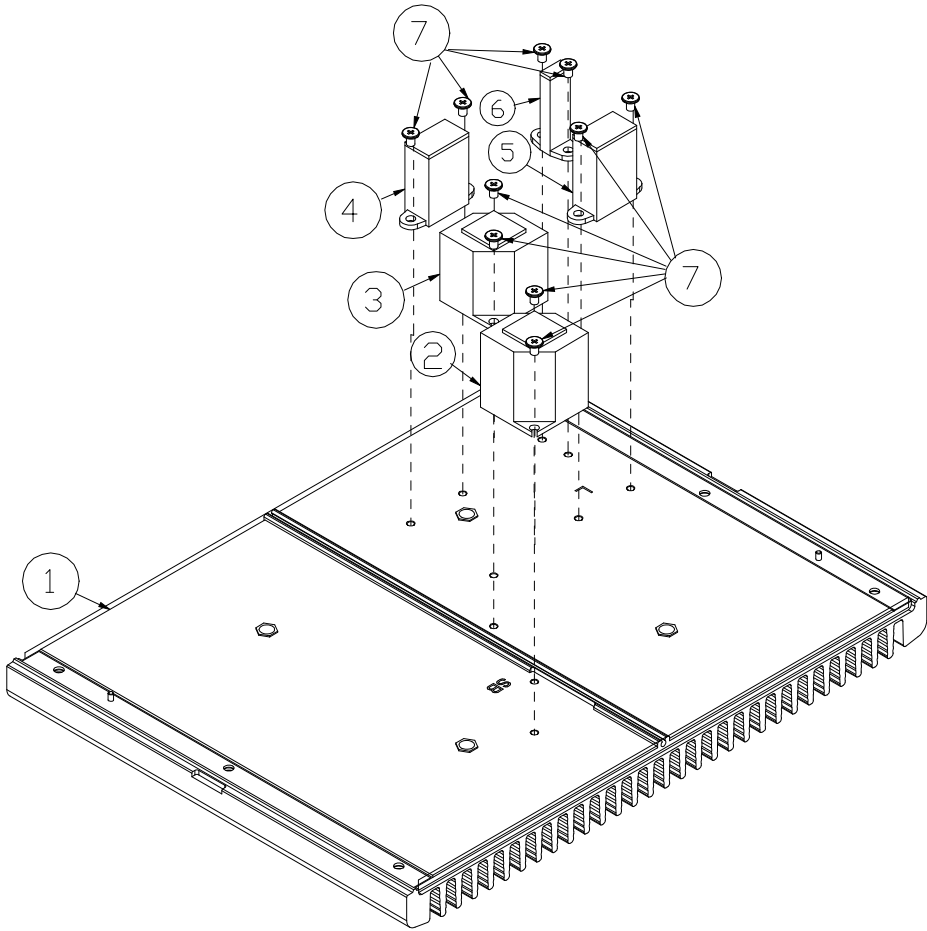

ITEM	COMPONENT NAME	PART No.	QTY
1	HEATSINK_TOP_COVER ;AL	21-002-16000004	1
2	HEATSINK_BLOCK_SOUTHBRIDGE ;AL	21-002-10000504	1
3	HEATSINK_BLOCK_CPU ;CU	21-002-10000505	1
4	HEATSINK_BLOCK_INDUCTOR_H ;AL	21-002-10000502	1
5	HEATSINK_BLOCK_INDUCTOR_L ;AL	21-002-10000503	1
6	HEATSINK_BLOCK_CONTROLLER ;AL	21-002-10000501	1
7	FILLISTR HEAD SCREW #2/M3x0.5Px4mm	82-272-30004018	10

EXPLODED DIAGRAM FOR HDD

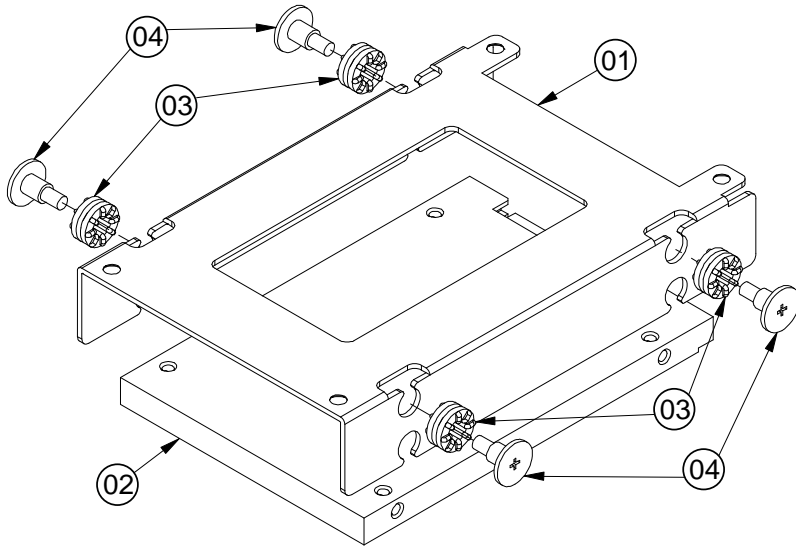

No.	COMPONENT NAME	PART No.	Q'TY
1	SE-8210 BASE BRACKET	20-006-03004261	1
2	HDD 2.5 Inch	--	1
3	RUBBER WASHER OD=φ9.62mm, ID=φ3.9mmx5.8T(Blue)	23-680-39580963	4
4	FILLISTR HEAD SCREW M3x0.5Px4.8mm	82-272-30005013	4

TECHNICAL SUMMARY

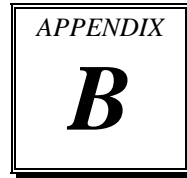

This section introduces you the maps concisely.

Section includes:

- Block Diagram
- Interrupt Map
- DMA Channels Map
- I/O Map
- Watchdog Timer Configuration
- Flash BIOS Update

BLOCK DIAGRAM

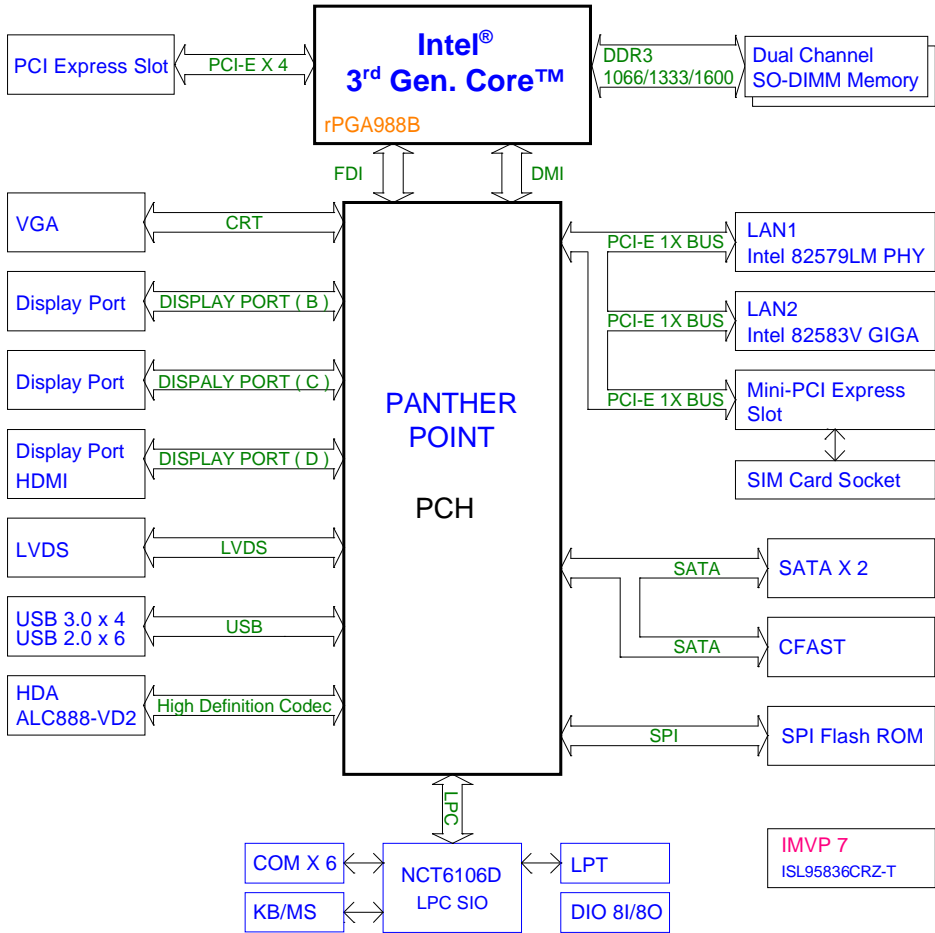

INTERRUPT MAP

IRQ	ASSIGNMENT
0	System timer
1	Standard PS/2 Keyboard
3	Communications Port (COM2)
4	Communications Port (COM1)
7	Communications Port (COM3)
7	Communications Port (COM4)
8	System CMOS/real time clock
11	Intel(R) 7 Series/C216 Chipset Family SMBus Host Controller - 1E22
12	Microsoft PS/2 Mouse
13	Numeric data processor
16	Intel(R) 7 Series/C216 Chipset Family PCI Express Root Port 1 - 1E10
16	Intel(R) 7 Series/C216 Chipset Family USB Enhanced Host Controller - 1E2D
16	Intel(R) Management Engine Interface
18	Intel(R) 7 Series/C216 Chipset Family PCI Express Root Port 3 - 1E14
19	Intel(R) Active Management Technology - SOL (COM7)
19	Intel(R) 7 Series/C216 Chipset Family 4 port Serial ATA Storage Controller - 1E01
19	Intel(R) 7 Series/C216 Chipset Family 2 port Serial ATA Storage Controller - 1E09
22	High Definition Audio Controller
23	Intel(R) 7 Series/C216 Chipset Family USB Enhanced Host Controller - 1E26
81	Microsoft ACPI-Compliant System
82	Microsoft ACPI-Compliant System
83	Microsoft ACPI-Compliant System
84	Microsoft ACPI-Compliant System
85	Microsoft ACPI-Compliant System

IRQ	ASSIGNMENT
86	Microsoft ACPI-Compliant System
87	Microsoft ACPI-Compliant System
88	Microsoft ACPI-Compliant System
89	Microsoft ACPI-Compliant System
90	Microsoft ACPI-Compliant System
91	Microsoft ACPI-Compliant System
92	Microsoft ACPI-Compliant System
93	Microsoft ACPI-Compliant System
94	Microsoft ACPI-Compliant System
95	Microsoft ACPI-Compliant System
96	Microsoft ACPI-Compliant System
97	Microsoft ACPI-Compliant System
98	Microsoft ACPI-Compliant System
99	Microsoft ACPI-Compliant System
100	Microsoft ACPI-Compliant System
101	Microsoft ACPI-Compliant System
102	Microsoft ACPI-Compliant System
103	Microsoft ACPI-Compliant System
104	Microsoft ACPI-Compliant System
105	Microsoft ACPI-Compliant System
106	Microsoft ACPI-Compliant System
107	Microsoft ACPI-Compliant System
108	Microsoft ACPI-Compliant System
109	Microsoft ACPI-Compliant System
110	Microsoft ACPI-Compliant System
111	Microsoft ACPI-Compliant System
112	Microsoft ACPI-Compliant System
113	Microsoft ACPI-Compliant System
114	Microsoft ACPI-Compliant System
115	Microsoft ACPI-Compliant System
116	Microsoft ACPI-Compliant System
117	Microsoft ACPI-Compliant System

IRQ	ASSIGNMENT
118	Microsoft ACPI-Compliant System
119	Microsoft ACPI-Compliant System
120	Microsoft ACPI-Compliant System
121	Microsoft ACPI-Compliant System
122	Microsoft ACPI-Compliant System
123	Microsoft ACPI-Compliant System
124	Microsoft ACPI-Compliant System
125	Microsoft ACPI-Compliant System
126	Microsoft ACPI-Compliant System
127	Microsoft ACPI-Compliant System
128	Microsoft ACPI-Compliant System
129	Microsoft ACPI-Compliant System
130	Microsoft ACPI-Compliant System
131	Microsoft ACPI-Compliant System
132	Microsoft ACPI-Compliant System
133	Microsoft ACPI-Compliant System
134	Microsoft ACPI-Compliant System
135	Microsoft ACPI-Compliant System
136	Microsoft ACPI-Compliant System
137	Microsoft ACPI-Compliant System
138	Microsoft ACPI-Compliant System
139	Microsoft ACPI-Compliant System
140	Microsoft ACPI-Compliant System
141	Microsoft ACPI-Compliant System
142	Microsoft ACPI-Compliant System
143	Microsoft ACPI-Compliant System
144	Microsoft ACPI-Compliant System
145	Microsoft ACPI-Compliant System
146	Microsoft ACPI-Compliant System
147	Microsoft ACPI-Compliant System
148	Microsoft ACPI-Compliant System
149	Microsoft ACPI-Compliant System

IRQ	ASSIGNMENT
150	Microsoft ACPI-Compliant System
151	Microsoft ACPI-Compliant System
152	Microsoft ACPI-Compliant System
153	Microsoft ACPI-Compliant System
154	Microsoft ACPI-Compliant System
155	Microsoft ACPI-Compliant System
156	Microsoft ACPI-Compliant System
157	Microsoft ACPI-Compliant System
158	Microsoft ACPI-Compliant System
159	Microsoft ACPI-Compliant System
160	Microsoft ACPI-Compliant System
161	Microsoft ACPI-Compliant System
162	Microsoft ACPI-Compliant System
163	Microsoft ACPI-Compliant System
164	Microsoft ACPI-Compliant System
165	Microsoft ACPI-Compliant System
166	Microsoft ACPI-Compliant System
167	Microsoft ACPI-Compliant System
168	Microsoft ACPI-Compliant System
169	Microsoft ACPI-Compliant System
170	Microsoft ACPI-Compliant System
171	Microsoft ACPI-Compliant System
172	Microsoft ACPI-Compliant System
173	Microsoft ACPI-Compliant System
174	Microsoft ACPI-Compliant System
175	Microsoft ACPI-Compliant System
176	Microsoft ACPI-Compliant System
177	Microsoft ACPI-Compliant System
178	Microsoft ACPI-Compliant System
179	Microsoft ACPI-Compliant System
180	Microsoft ACPI-Compliant System
181	Microsoft ACPI-Compliant System

IRQ	ASSIGNMENT
182	Microsoft ACPI-Compliant System
183	Microsoft ACPI-Compliant System
184	Microsoft ACPI-Compliant System
185	Microsoft ACPI-Compliant System
186	Microsoft ACPI-Compliant System
187	Microsoft ACPI-Compliant System
188	Microsoft ACPI-Compliant System
189	Microsoft ACPI-Compliant System
190	Microsoft ACPI-Compliant System
4294967292	Intel(R) 82579LM Gigabit Network Connection
4294967293	Intel(R) USB 3.0 eXtensible Host Controller
4294967294	Intel(R) HD Graphics 4000

Note: The resource information is gathered on Windows 7 (the IRQ could be assigned differently depending on your OS).

DMA CHANNELS MAP

TIMER CHANNEL	ASSIGNMENT
Channel 4	Direct memory access controller

I/O MAP

I/O MAP	ASSIGNMENT
0x00000000-0x0000001F	Direct memory access controller
0x00000000-0x0000001F	PCI bus
0x00000010-0x0000001F	Motherboard resources
0x00000020-0x00000021	Programmable interrupt controller
0x00000022-0x0000003F	Motherboard resources
0x00000024-0x00000025	Programmable interrupt controller
0x00000028-0x00000029	Programmable interrupt controller
0x0000002C-0x0000002D	Programmable interrupt controller
0x0000002E-0x0000002F	Motherboard resources
0x00000030-0x00000031	Programmable interrupt controller
0x00000034-0x00000035	Programmable interrupt controller
0x00000038-0x00000039	Programmable interrupt controller
0x0000003C-0x0000003D	Programmable interrupt controller
0x00000040-0x00000043	System timer
0x00000044-0x0000005F	Motherboard resources
0x0000004E-0x0000004F	Motherboard resources
0x00000050-0x00000053	System timer
0x00000060-0x00000060	Standard PS/2 Keyboard
0x00000061-0x00000061	Motherboard resources
0x00000063-0x00000063	Motherboard resources
0x00000064-0x00000064	Standard PS/2 Keyboard
0x00000065-0x00000065	Motherboard resources
0x00000067-0x00000067	Motherboard resources
0x00000070-0x00000077	System CMOS/real time clock
0x00000070-0x00000077	Motherboard resources
0x00000072-0x0000007F	Motherboard resources
0x00000080-0x00000080	Motherboard resources
0x00000080-0x00000080	Motherboard resources
0x00000081-0x00000091	Direct memory access controller
0x00000084-0x00000086	Motherboard resources

I/O MAP	ASSIGNMENT
0x00000088-0x00000088	Motherboard resources
0x0000008C-0x0000008E	Motherboard resources
0x00000090-0x0000009F	Motherboard resources
0x00000092-0x00000092	Motherboard resources
0x00000093-0x0000009F	Direct memory access controller
0x000000A0-0x000000A1	Programmable interrupt controller
0x000000A2-0x000000BF	Motherboard resources
0x000000A4-0x000000A5	Programmable interrupt controller
0x000000A8-0x000000A9	Programmable interrupt controller
0x000000AC-0x000000AD	Programmable interrupt controller
0x000000B0-0x000000B1	Programmable interrupt controller
0x000000B2-0x000000B3	Motherboard resources
0x000000B4-0x000000B5	Programmable interrupt controller
0x000000B8-0x000000B9	Programmable interrupt controller
0x000000BC-0x000000BD	Programmable interrupt controller
0x000000C0-0x000000DF	Direct memory access controller
0x000000E0-0x000000EF	Motherboard resources
0x000000F0-0x000000FF	Numeric data processor
0x00000290-0x0000029F	Motherboard resources
0x000002A0-0x000002AF	Motherboard resources
0x000002E8-0x000002EF	Communications Port (COM4)
0x000002F8-0x000002FF	Communications Port (COM2)
0x00000378-0x0000037F	Printer Port (LPT1)
0x000003B0-0x000003BB	Intel(R) HD Graphics 4000
0x000003C0-0x000003DF	Intel(R) HD Graphics 4000
0x000003E8-0x000003EF	Communications Port (COM3)
0x000003F8-0x000003FF	Communications Port (COM1)
0x00000400-0x00000453	Motherboard resources
0x00000454-0x00000457	Motherboard resources
0x00000458-0x0000047F	Motherboard resources
0x000004D0-0x000004D1	Motherboard resources
0x000004D0-0x000004D1	Programmable interrupt controller

I/O MAP	ASSIGNMENT
0x00000500-0x0000057F	Motherboard resources
0x00000680-0x0000069F	Motherboard resources
0x00000D00-0x0000FFFF	PCI bus
0x00001000-0x0000100F	Motherboard resources
0x0000164E-0x0000164F	Motherboard resources
0x0000E000-0x0000EFFF	Intel(R) 7 Series/C216 Chipset Family PCI Express Root Port 3 - 1E14
0x0000F000-0x0000F03F	Intel(R) HD Graphics 4000
0x0000F040-0x0000F05F	Intel(R) 7 Series/C216 Chipset Family SMBus Host Controller - 1E22
0x0000F080-0x0000F08F	Intel(R) 7 Series/C216 Chipset Family 2 port Serial ATA Storage Controller - 1E09
0x0000F090-0x0000F09F	Intel(R) 7 Series/C216 Chipset Family 2 port Serial ATA Storage Controller - 1E09
0x0000F0A0-0x0000F0A3	Intel(R) 7 Series/C216 Chipset Family 2 port Serial ATA Storage Controller - 1E09
0x0000F0B0-0x0000F0B7	Intel(R) 7 Series/C216 Chipset Family 2 port Serial ATA Storage Controller - 1E09
0x0000F0C0-0x0000F0C3	Intel(R) 7 Series/C216 Chipset Family 2 port Serial ATA Storage Controller - 1E09
0x0000F0D0-0x0000F0D7	Intel(R) 7 Series/C216 Chipset Family 2 port Serial ATA Storage Controller - 1E09
0x0000F0E0-0x0000F0EF	Intel(R) 7 Series/C216 Chipset Family 4 port Serial ATA Storage Controller - 1E01
0x0000F0F0-0x0000F0FF	Intel(R) 7 Series/C216 Chipset Family 4 port Serial ATA Storage Controller - 1E01
0x0000F100-0x0000F103	Intel(R) 7 Series/C216 Chipset Family 4 port Serial ATA Storage Controller - 1E01
0x0000F110-0x0000F117	Intel(R) 7 Series/C216 Chipset Family 4 port Serial ATA Storage Controller - 1E01
0x0000F120-0x0000F123	Intel(R) 7 Series/C216 Chipset Family 4 port Serial ATA Storage Controller - 1E01
0x0000F130-0x0000F137	Intel(R) 7 Series/C216 Chipset Family 4 port Serial ATA Storage Controller - 1E01

I/O MAP	ASSIGNMENT
0x0000F140-0x0000F147	Intel(R) Active Management Technology - SOL (COM7)
0x0000FFFF-0x0000FFFF	Motherboard resources
0x0000FFFF-0x0000FFFF	Motherboard resources

WATCHDOG TIMER CONFIGURATION

The I/O port address of the watchdog timer is 2E (hex) and 2F (hex). 2E (hex) is the address port. 2F (hex) is the data port. User must first assign the address of register by writing address value into address port 2E (hex), then write/read data to/from the assigned register through data port 2F (hex).

Configuration Sequence

To program [NCT6106D](#) configuration registers, the following configuration sequence must be followed:

- (1) Enter the extended function mode
- (2) Configure the configuration registers
- (3) Exit the extended function mode

(1) Enter the extended function mode

To place the chip into the Extended Function Mode, two successive writes of 0x87 must be applied to Extended Function Enable Registers (EFERs, i.e. 2Eh or 4Eh).

(2) Configure the configuration registers

The chip selects the Logical Device and activates the desired Logical Devices through Extended Function Index Register (EFIR) and Extended Function Data Register (EFDR). The EFIR is located at the same address as the EFER, and the EFDR is located at address (EFIR+1). First, write the Logical Device Number (i.e. 0x07) to the EFIR and then write the number of the desired Logical Device to the EFDR. If accessing the Chip (Global) Control Registers, this step is not required. Secondly, write the address of the desired configuration register within the Logical Device to the EFIR and then write (or read) the desired configuration register through the EFDR.

(3) Exit the extended function mode

To exit the Extended Function Mode, writing 0xAA to the EFER is required. Once the chip exits the Extended Function Mode, it is in the normal running mode and is ready to enter the configuration mode.

Code example for watchdog timer

Enable and start watchdog timer, then set 30 seconds as the timeout interval.

```
----- Enter to extended function mode -----  
Mov  dx,    2eh  
Mov  al,    87h  
Out  dx,    al  
Out  dx,    al  
----- Select Logical Device 8 of watchdog timer -----  
Mov  al,    07h  
Out  dx,    al  
Inc  dx  
Mov  al,    08h  
Out  dx,    al  
----- Set second as counting unit -----  
Dec  dx  
Mov  al,    0f5h  
Out  dx,    al  
Inc  dx  
In   al,    dx  
And  al,    not 08h  
Out  dx,    al  
----- Set timeout interval as 30seconds and start counting -----  
Dec  dx  
Mov  al,    0f6h  
Out  dx,    al  
Inc  dx  
Mov  al,    30  
Out  dx,    al  
----- Exit the extended function mode -----  
Dec  dx  
Mov  al,    0aah  
Out  dx,    al
```

FLASH BIOS UPDATE

I. Before system BIOS update

1. Prepare a bootable media (e.g. USB storage device) which can boot system to DOS prompt.
2. Download and save the BIOS file (e.g. [620x0Pxx.bin](#)) to the bootable device.
3. Copy AMI flash utility – AFUDOS.exe (V2.35) into a bootable device

```
C:\flash>dir

Volume in drive C is PROTECH
Volume Serial Number is 3CCE-a150
Directory of C:\flash

                <DIR>                12-14-12    5.50P
                <DIR>                12-14-12    5.50P
AFUDOS      EXE      159,008    03-04-10    4.16p
README     TXT       2,684    03-04-10    2.33p
AFUDOS     TXT       2,906    03-04-10    3.02p
620x0Pxx   BIN     8,388,608    12-24-12    3.32p
      4 file(d)                8,553,206 bytes
      2 dir(s)                787,197,952 bytes free

C:\flash>
```

4. Make sure the target system can first boot to the bootable device.
 - a. Connect the bootable USB device.
 - b. Turn on the computer and press <ESC> or key during boot to enter BIOS setup menu.
 - c. System will go into the BIOS setup menu.
 - d. Select [Boot] menu as the picture shows below.
 - e. Select [Hard Drive BBS Priorities], set the USB bootable device to be the 1st boot device.
 - f. Press <F4> key to save configuration and exit the BIOS setup menu.

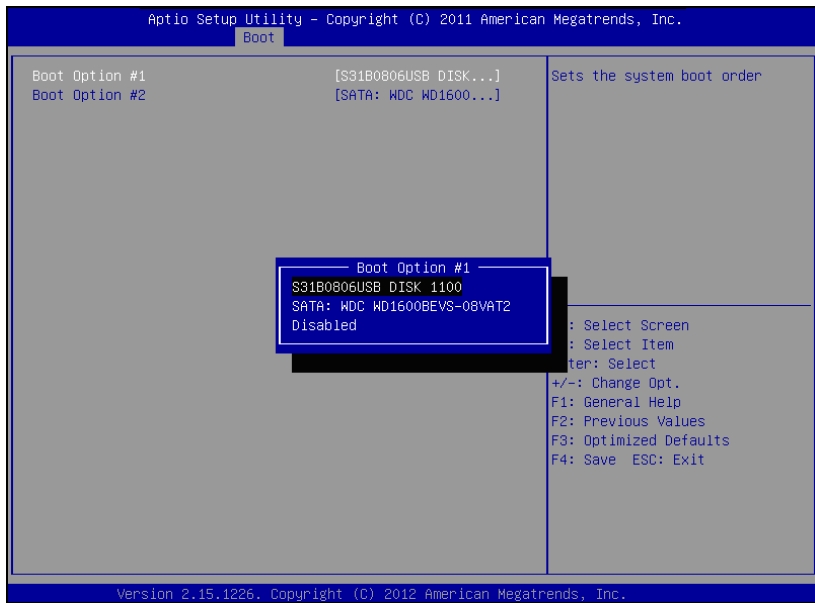

II. AFUDOS command for system BIOS update

AFUDOS.exe is aforementioned AMI firmware update utility; the command line is shown as below:

`AFUDOS <ROM File Name> [option1] [option2]...`

You can type `AFUDOS /?` to see all the definition of each control options. The recommended options for BIOS ROM update consist of following parameters:

`/P`: program main BIOS image

`/B`: program Boot Block

`/N`: program NVRAM

`/X`: don't check ROM ID

III. BIOS update procedure

1. Use the bootable USB device to boot up system into the MS-DOS command prompt
2. Type in `AFUDOS 620x0Pxx.bin /p /b /n /x` and press enter to start the flash procedure

Note: `xxxx` means the BIOS revision part, ex. 0Px1...

3. During the update procedure, you will see the BIOS update process status and its percentage. **Beware!** Do not turn off system power or reset your computer if the whole procedure are not complete yet, or it may crash the BIOS ROM and make system unable to boot up next time.
4. After BIOS update procedures is complete, the messages from AFUDOS utility should be like the figure shown below.

```
C:\DOS>afudos 620x0Pxx.BIN /P /B /N /X
+-----+
+          AMI Firmware Update Utility(APTIO)          v2.35          +
+   Copyright (C) 2010 American Megatrends Inc. All Rights Reserved.   +
+-----+

Reading file ..... done
FFS checksums ..... ok
Erasing flash ..... done
Writing flash ..... done
Verifying flash ..... done
Erasing NVRAM ..... done
Writing NVRAM ..... done
Verifying NVRAM ..... done
Erasing BootBlock ..... done
Verifying BootBlock ... done

C:\DOS>
```

5. You can restart the system and boot up with new BIOS now
6. Update is complete after restart

7. Verify during the following boot that BIOS version displayed at the initialization screen has changed..

