

USER'S MANUAL

PA-3122

10.4" POS Terminal

Powered by Intel® Celeron®

J1900 Quad-Core

PA-3122 M3

PA-3122 POS System

With SATA/mSATA/3COM/4USB

COPYRIGHT NOTICE & TRADEMARK

All trademarks and registered trademarks mentioned herein are the property of their respective owners.

This manual is copyrighted in April 2016. You may not reproduce or transmit in any form or by any means, electronic, or mechanical, including photocopying and recording.

DISCLAIMER

This user's manual is meant to assist users in installing and setting up the system. The information contained in this document is subject to change without any notice.

CE NOTICE

This is a class A product. In a domestic environment this product may cause radio interference in which case the user may be required to take adequate measures.

FCC NOTICE

This equipment has been tested and found to comply with the limits for a Class A digital device, pursuant to part 15 of the FCC Rules. These limits are designed to provide reasonable protection against harmful interference when the equipment is operated in a commercial environment. This equipment generates, uses, and can radiate radio frequency energy and, if not installed and used in accordance with the instruction manual, may cause harmful interference to radio communications. Operation of this equipment in a residential area is likely to cause harmful interference in which case the user will be required to correct the interference at his own expense.

You are cautioned that any change or modifications to the equipment not expressly approve by the party responsible for compliance could void your authority to operate such equipment.

CAUTION! Danger of explosion if battery is incorrectly replaced. Replace only with the same or equivalent type recommended by the manufacturer. Dispose of used batteries according to the manufacturer's instructions.

WARNING! Some internal parts of the system may have high electrical voltage. And therefore we strongly recommend that qualified engineers can open and disassemble the system. The LCD and Touchscreen are easily breakable, please handle them with extra care.

TABLE OF CONTENTS

CHAPTER 1 INTRODUCTION

1-1	About This Manual.....	1-2
1-2	POS System Illustration.....	1-3
1-3	System Specifications.....	1-4
1-4	Safety Precautions.....	1-6

CHAPTER 2 SYSTEM CONFIGURATION

2-1	System External I/O Port & Pin Assignment.....	2-2
2-2	Main Board Component Locations & Jumper Settings.....	2-7
2-3	Printer Board Component Locations & Pin Assignment.....	2-29
2-4	VFD Board Component Locations & Pin Assignment.....	2-47
2-5	MSR Board Component Locations & Pin Assignment.....	2-49

CHAPTER 3 SOFTWARE

3-1	Driver.....	3-2
3-2	Embedded Peripheral Devices.....	3-8
3-3	API.....	3-44
3-4	BIOS Operation.....	3-57
3-5	Watchdog Timer Configuration.....	3-99
3-6	BIOS Update Instructions.....	3-102
3-7	System Resource Map.....	3-106

CHAPTER 4 SYSTEM DIAGRAMS

	Exploded Diagram for System Top Case.....	4-2
	Exploded Diagram for System LCD Panel.....	4-9
	Exploded Diagram for System Bottom Case.....	4-13
	Exploded Diagram for Printer.....	4-19
	Exploded Diagram for MSR.....	4-25
	Exploded Diagram for VFD.....	4-26
	Exploded Diagram for HDD.....	4-28

INTRODUCTION

CHAPTER

1

This chapter gives you the information for the PA-3122. It also outlines the system specifications.

The following sections are included:

- About This Manual
- POS System Illustration
- System Specifications
- Safety precautions

Experienced users can jump to chapter 2 on page 2-1 for a quick start.

1-1. ABOUT THIS MANUAL

Thank you for purchasing our PA-3122 Series System. The PA-3122 is an updated system designed to be comparable with the highest performance of IBM AT personal computers. The PA-3122 provides faster processing speed, greater expandability and can handle more tasks than before. This manual is designed to assist you how to install and set up the whole system. It contains four chapters and two appendixes. Users can configure the system according to their own needs.

Chapter 1 Introduction

This chapter introduces you to the background of this manual. It also includes illustrations and specifications for the whole system. The final section of this chapter indicates some safety reminders on how to take care of your system.

Chapter 2 System Configuration

This chapter outlines the location of motherboard, printer, VFD, MSR components and their function. You will learn how to set the jumpers and configure the system to meet your own needs.

Chapter 3 Software

This chapter contains detailed information for driver installations of the Intel[®] Utility, VG, LAN, Sound, Touchscreen, embedded peripheral devices, BIOS setup & update, Watchdog timer and resource map.

Chapter 4 System Diagrams

This chapter shows the exploded diagrams and part numbers of PA-3122 components.

1-2. POS SYSTEM ILLUSTRATION

Top View

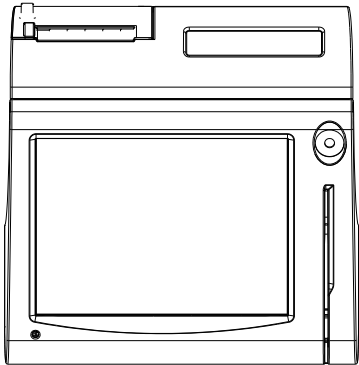

Bottom View

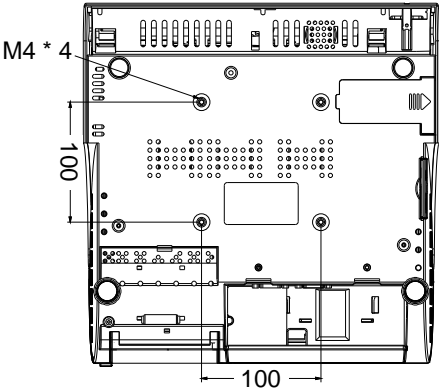

Front View

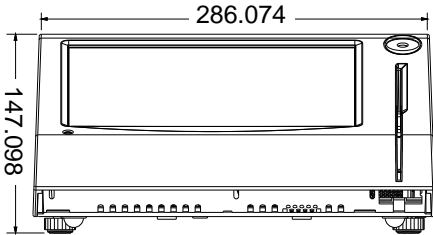

Rear View

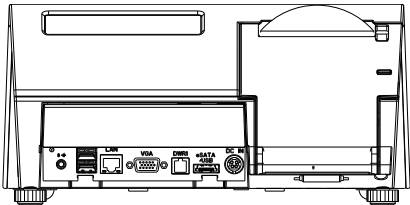

Side View

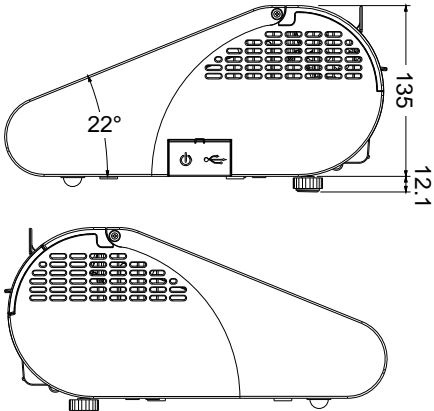

Quarter View

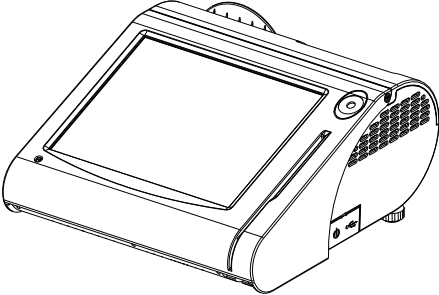

Unit: mm

1-3. SYSTEM SPECIFICATIONS

System

CPU	Intel® Celeron® J1900 Quad-Core 2.0GHz
Memory	1 x DDR3L SO-DIMM 204-pin socket, up to 8GB
OS Support	Microsoft Windows 8 & POSReady7
Power Supply	72~120 Watt power adapter
Audio	2W speaker
BIOS	AMI SPI BIOS, 8 Mbits with VGA BIOS
System Weight	With power adapter approx. 4.5 kg
Dimension (W x H x D)	300mm x 299mm x 135mm
Certificate	CE/FCC

Storage

SATA	1 x 2.5" HDD or SSD
mSATA	1 x SSD

I/O Ports

Serial Port	<ul style="list-style-type: none"> ▪ 3 x DB-9 (COM2,COM3,COM4; COM1 is optional.) ▪ 5 x wafers on board: <ul style="list-style-type: none"> - COM1-1: Co-lay with COM1 - COM2-1: Co-lay with COM2 - COM3-1: Co-lay with COM3 - COM4-1: Co-lay with COM4-2
USB	5 x USB2.0 (4 on rear I/O, 1 on side bezel)
Parallel Port (Optional)	1 x printer port
LAN	1 x Giga LAN
VGA	1 x DB-15 VGA Interface

Display

LCD Interface	10.4" TFT XGA
Max. Resolution	<ul style="list-style-type: none"> ▪ 1024 x 768 ▪ 800 x 600
Brightness	<ul style="list-style-type: none"> ▪ 400 cd/m2
Signal Interface	TTL (18-bit)
Viewing Angel	24~30°
Touch Panel	10.4" 5-wire analog resistive

Environment

Temperature	<ul style="list-style-type: none">▪ Operating: 0~35°C (32 ~ 95°F)▪ Storage: -5~60°C (-4 ~ 140°F)
Humidity	20~90%

Optional accessories

Customer Display	VFD kit, 20 columns & 2 lines (Each column contains 5x7 dots.)
Printer	2" or 3" easy-loading thermal printer with auto-cutter
MSR & i-Button	ISO I ,II, III; JIS I,II and support information key
RFID	ISO14443A Read/Write; ISO18092 Read only
Fingerprint	8-bit grayscale reader

1-4. SAFETY PRECAUTIONS

The following messages are safety reminders on how to protect your systems from damages, and extending the life cycle of the system.

1. Check the Line Voltage
 - a. The operating voltage for the power supply should be within the range of 100V to 240V AC; otherwise the system may be damaged.

2. Environmental Conditions
 - a. Place your PA-3122 on a sturdy, level surface. Be sure to allow enough space around the system to have easy access needs.
 - b. Avoid installing your PA-3122 Series POS system in extremely hot or cold places.
 - c. Avoid exposure to sunlight for a long period of time (for example, in a closed car in summer time. Also avoid the system from any heating device.). Or do not use the PA-3122 when it has been left outdoors in a cold winter day.
 - d. Bear in mind that the operating ambient temperature is between 0°C and 35°C (32°F and 95°F).
 - e. Avoid moving the system rapidly from a hot place to a cold place, and vice versa, because condensation may occur inside the system.
 - f. Protect your PA-3122 against strong vibrations, which may cause hard disk failure.
 - g. Do not place the system too close to any radio-active device. Radio-active device may cause signal interference.
 - h. Always shutdown the operation system before turning off the power.

3. Handling
 - a. Avoid placing heavy objects on the top of the system.
 - b. Do not turn the system upside down. This may cause the hard drive to malfunction.
 - c. Do not allow any objects to fall into this product.
 - d. If water or other liquid spills into the product, unplug the power cord immediately.

4. Good Care
 - a. When the outside case gets stained, remove the stains using neutral washing agent with a dry cloth.
 - b. Never use strong agents such as benzene and thinner to clean the surface of the case.
 - c. If heavy stains are present, moisten a cloth with diluted neutral washing agent or alcohol and then wipe thoroughly with a dry cloth.
 - d. If dust is accumulated on the case surface, remove it by using a special vacuum cleaner for computers.

SYSTEM CONFIGURATION

CHAPTER

2

Helpful information that describes the jumper and connector settings, component locations, and pin assignment.

The following sections are included:

- External I/O Port Pin Assignment
- How to Set Jumpers
- Component Locations & Jumper Settings
 - Mainboard
 - Printer Board (peripheral device)
 - VFD Board (peripheral device)
 - MSR Board (peripheral device)

2-1. SYSTEM EXTERNAL I/O PORT & PIN ASSIGNMENT

Rear I/O

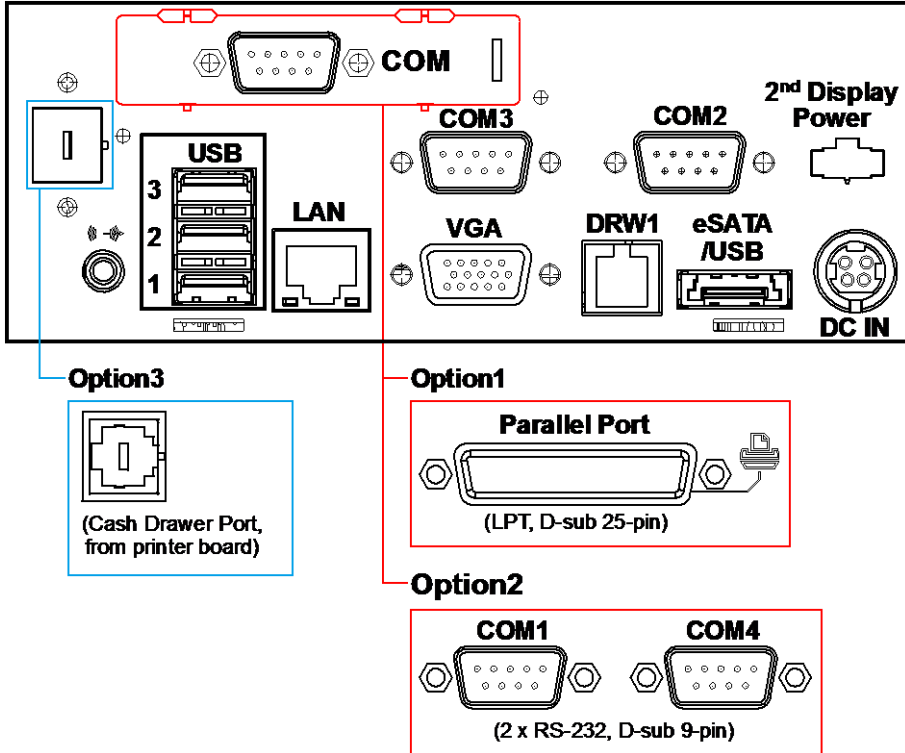

Side I/O

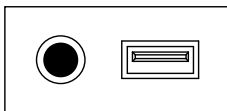

Power button USB4

2-1-1. Power Button

To turn on the system, press the power button on the side of the system briefly.

ACTION	ASSIGNMENT
Click	0V
Release	+3.3V



**Power
Button**

2-1-2. DC-IN Port

DC IN: DC Power-In Port (rear IO)

PIN	ASSIGNMENT	PIN	ASSIGNMENT
1	GND	3	+24V
2	GND	4	+24V

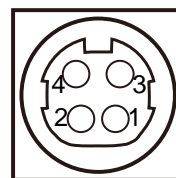

DC IN

2-1-3. VGA Port

VGA: VGA Port, D-Sub 15-pin (rear IO)

PIN	ASSIGNMENT	PIN	ASSIGNMENT
1	RED	9	+5V
2	GREEN	10	GND
3	BLUE	11	NC
4	NC	12	DDCA DATA
5	GND	13	HSYNC
6	GND	14	VSYNC
7	GND	15	DDCA CLK
8	GND		

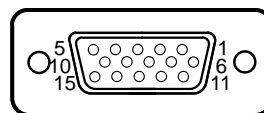

VGA

2-1-4. COM Port

COM2, COM3, COM4: D-Sub9 Serial Ports (rear IO)

- COM2: Co-lay with COM2-1
- COM3: Co-lay with COM3-1

PIN	ASSIGNMENT	PIN	ASSIGNMENT
1	DCD	6	DSR
2	RXD	7	RTS
3	TXD	8	CTS
4	DTR	9	RI/+5V/+12V selectable (Max. current: 1A)
5	GND		

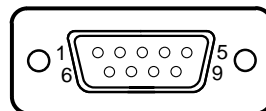

**COM2/
COM3/
COM4**

Note: COM3 & COM3-1 will not function when jumpers JP20, JP21, JP22 are set as 2-3 connected (i-Button). Refer to the section *i-Button Function Selection* for details. COM4-2 will not function when COM4-1 is selected as the printer control interface.

2-1-5. LAN Port

LAN: LAN RJ45 Port (rear IO)

PIN	ASSIGNMENT	PIN	ASSIGNMENT
1	MDIP0	5	MDIP2
2	MDIN0	6	MDIN2
3	MDIP1	7	MDIP3
4	MDIN1	8	MDIN3

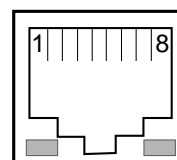

**Green Yellow
LAN**

LAN LED Indicator:

Right Side LED

Yellow Color Blinking	LAN Message Active
Off	No LAN Message Active

Left Side LED

Green Color On	10/100Mbps LAN Speed Indicator
Orange Color on	Giga LAN Speed Indicator
Off	No LAN switch/ hub connected.

2-1-6. Cash Drawer Port

DRW1: Signal from M/B GPIO (rear I/O)

PIN	ASSIGNMENT	PIN	ASSIGNMENT
1	GND	4	+12V/+24V (Max. current: 1A)
2	Drawer Open	5	NC
3	Drawer Sense	6	GND

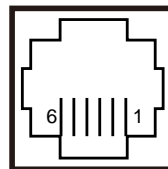

DRW1

SIO Address	
Cash drawer 1	LDN 06, 0x91 bit 1
Cash drawer 2	LDN 06, 0x91 bit 3

2-1-7. USB Ports

USB0, USB1, USB2, USB3, USB4: USB Type A Ports

- USB0~3: Rear I/O
- USB4: Side IO

PIN	ASSIGNMENT	PIN	ASSIGNMENT
1	+5V (Max. current: 0.5A)	3	D+
2	D-	4	GND



USB0/

USB1/

USB2/

USB4

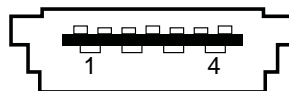

USB3

2-1-8. Printer Port (Optional)

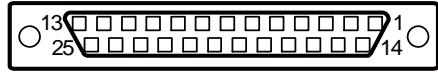

LPT

LPT: Printer Port, D-Sub 25-pin, co-lay with LPT1

PIN	ASSIGNMENT	PIN	ASSIGNMENT
1	STBJ	14	ALFJ
2	PDR0	15	ERRJ
3	PDR1	16	PARR_INITJ
4	PDR2	17	SLCTINJ
5	PDR3	18	GND
6	PDR4	19	GND
7	PDR5	20	GND
8	PDR6	21	GND
9	PDR7	22	GND
10	ACKJ	23	GND
11	BUSY	24	GND
12	PE	25	GND
13	SLCTJ		

2-2. MAINBOARD COMPONENT LOCATIONS & JUMPER SETTINGS

M/B: PB-6822

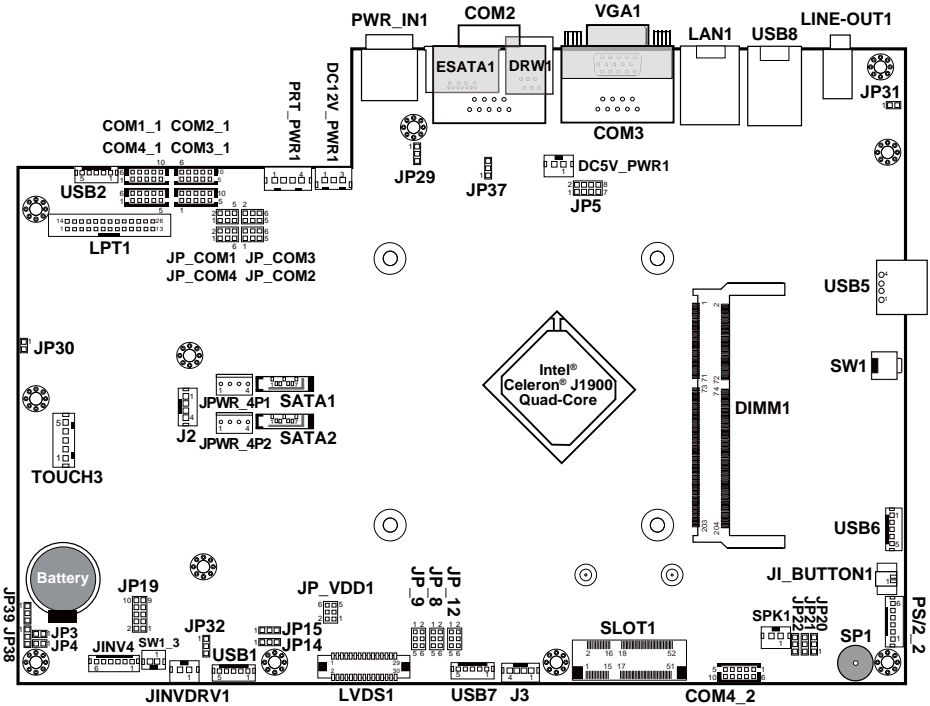

PB-6822 Mainboard Component Locations

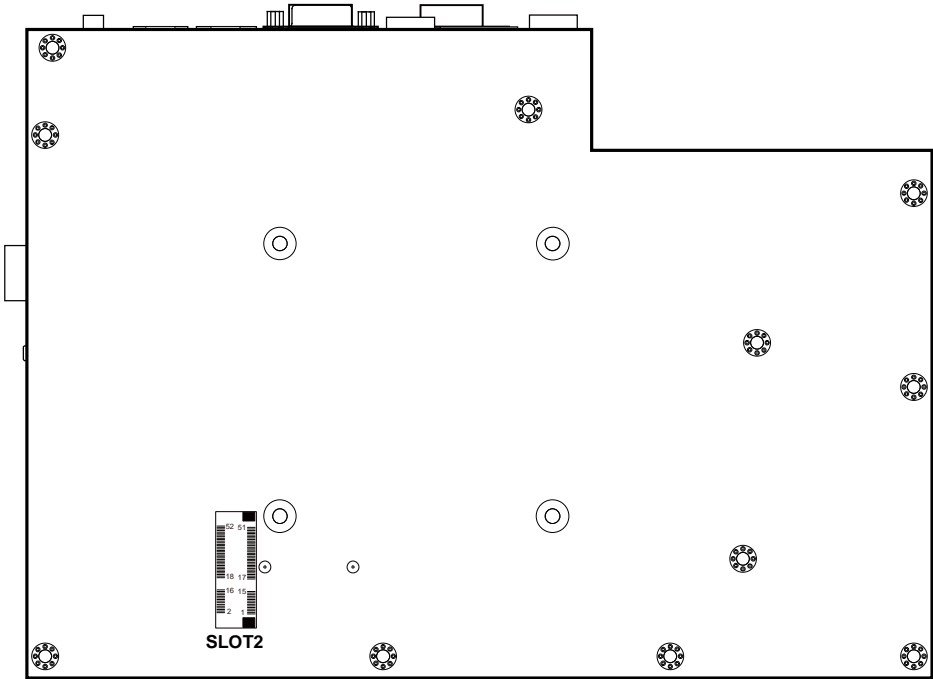

PB-6822 Mainboard Component Locations - Rear

2-2-1. How to Set Jumpers

You can configure your board by setting the jumpers. A jumper consists of two or three metal pins with a plastic base mounted on the card, and by using a small plastic "cap", also known as the jumper cap (with a metal contact inside), you are able to connect the pins. So you can set-up your hardware configuration by "opening" or "closing" pins.

Jumpers can be combined into sets that called jumper blocks. When jumpers are all in the block, you have to put them together to set up the hardware configuration. The figure below shows what this looks like.

Jumpers & caps

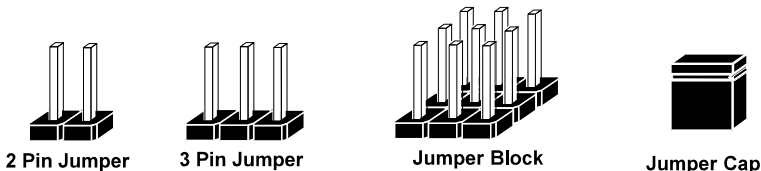

If a jumper has three pins for example, labelled PIN1, PIN2, and PIN3. You can connect PIN1 & PIN2 to create one setting and shorting. You can either connect PIN2 & PIN3 to create another setting. The same jumper diagrams are applied all through this manual. The figure below shows what the manual diagrams look and what they represent.

Jumper diagrams



Jumper Cap looks like this

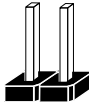

2 pin Jumper looks like this

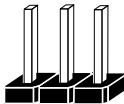

3 pin Jumper looks like this

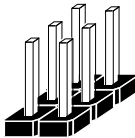

Jumper Block looks like this

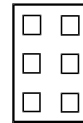

Jumper settings



2 pin Jumper closed(enabled)
looks like this

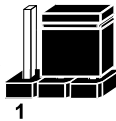

3 pin Jumper
2-3 pin closed(enabled)
looks like this

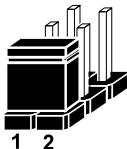
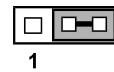

Jumper Block
1-2 pin closed(enabled)
looks like this

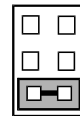

2-2-2. COM Port RI & Voltage Selection

JP_COM1, JP_COM2, JP_COM3, JP_COM4: Pin-headers on board

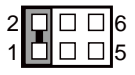
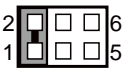
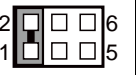
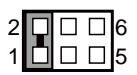
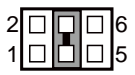
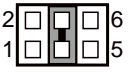
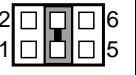
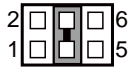
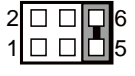
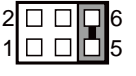
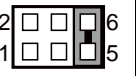
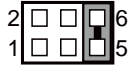
SELECTION	JUMPER SETTING	JUMPER ILLUSTRATION			
RI	1-2	 JP_COM1	 JP_COM2	 JP_COM3	 JP_COM4
+12V	3-4	 JP_COM1	 JP_COM2	 JP_COM3	 JP_COM4
+5V	5-6	 JP_COM1	 JP_COM2	 JP_COM3	 JP_COM4

Note: Manufacturing Default is RI for JP_COM1 & JP_COM4, and open (no connection) for JP_COM2 & JP_COM3

Caution:

1. Voltage of external COM 2 & COM3 ports are adjustable on BIOS or with the corresponding jumpers JP_COM2 & JP_COM3. Either way **cannot** be applied simultaneously in case of system error, component damage or serious boot failure. For instance, JP_COM2 will be enabled if COM2 is disabled on BIOS.
2. There is no pin connection for JP_COM2 or JP_COM3 by default. Refer to *Voltage Adjust Configuration* in chapter 3 for detailed BIOS setting (BIOS default at Disabled).
3. Voltage of COM1 or COM4 is not adjustable on BIOS.

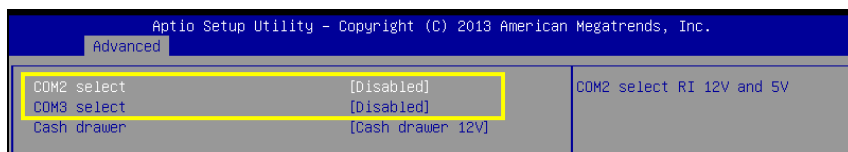

2-2-3. COM Connector

COM1-1, COM2-1, COM3-1, COM4-1, COM4-2: COM Connectors

PIN	ASSIGNMENT	PIN	ASSIGNMENT
1	DCD	6	DSR
2	RXD	7	RTS
3	TXD	8	CTS
4	DTR	9	RI/+5V/+12V selectable (Max. current: 1A)
5	GND	10	NC



**COM1-1/
COM2-1/
COM3-1/
COM4-1**

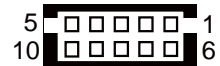

COM4-2

Note: Each COM connector is selectable for RI/+5V/+12V.
For details, refer to *COM Port RI & Voltage Selection*.

2-2-4. i-Button Connector

JI_BUTTON1: i-Button Connector

PIN	ASSIGNMENT
1	COM3_DTR_R_I
2	COM3_RXD_R_I

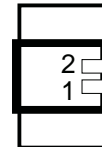

JI_BUTTON1

2-2-5. COM3 / i-Button Function Selection

JP20, JP21, JP22: COM3 / i-Button Function Connectors

SELECTION	JUMPER SETTING	JUMPER ILLUSTRATION
COM 3	1-2	<p>JP20/JP21/JP22</p>
i-Button*	2-3	<p>JP20/JP21/JP22</p>

Note: Manufacturing Default is COM3.

*COM3 & COM3-1 will not function when jumpers JP20, JP21 & JP22 are set as “i-Button.”

2-2-6. Cash Drawer Control Selection

JP37: DRW1, DRW1-1, DRW1-2

DRW1 port is used by default. You can add a second port via either of the methods below:

Method 1:

DRW1 includes two groups of GPIO pins. The second group is normally unused but can be enabled by the jumper. Set the pin header jumper JP37 as 1-2 connected if necessary.

Method 2:

You can split DRW1 into two channels of DRW1-1 & DRW1-2 using the Y-Cable (option).

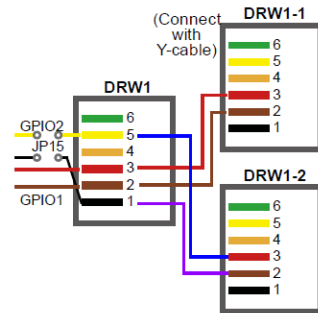

JP37: Cash Drawer control connector

SELECTION	JUMPER SETTING	JUMPER ILLUSTRATION
DRW1-1 & DRW1-2	1-2	1 JP37
GND (Default)	2-3	1 JP37

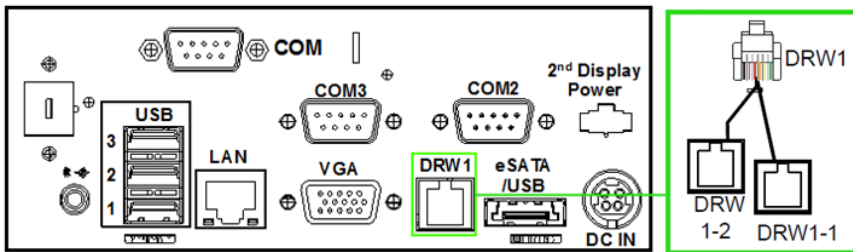

Step 3.

DRW1, DRW1-1, DRW1-2 shares the same power source. (Default: 12V).

SIO Address	
Cash drawer 1	LDN 06, 0x91 bit 1
Cash drawer 2	LDN 06, 0x91 bit 3

CASH DRAWER CONFIGURATION

The I/O port address of the cash drawer is 2E (hex) and 2F (hex). 2E (hex) is the address port. 2F (hex) is the data port. User must first assign the address of register by writing address value into address port 2E (hex), then write/read data to/from the assigned register through data port 2F (hex).

Configuration Sequence

To program [F81866](#) configuration registers, the following configuration sequence must be followed:

- (1) Enter the extended function mode
- (2) Configure the configuration registers
- (3) Exit the extended function mode

(1) Enter the extended function mode

To place the chip into the Extended Function Mode, [two successive writes of 0x87](#) must be applied to Extended Function Enable Registers (EFERs, i.e. 2Eh or 4Eh).

(2) Configure the configuration registers

The chip selects the Logical Device and activates the desired Logical Devices through Extended Function Index Register (EFIR) and Extended Function Data Register (EFDR). The EFIR is located at the same address as the EFER, and the EFDR is located at address (EFIR+1). First, write the Logical Device Number (i.e. 0x06) to the EFIR and then write the number of the desired Logical Device to the EFDR. If accessing the Chip (Global) Control Registers, this step is not required. Secondly, write the address of the desired configuration register within the Logical Device to the EFIR and then write (or read) the desired configuration register through the EFDR.

(3) Exit the extended function mode

To exit the Extended Function Mode, [writing 0xAA to the EFER](#) is required. Once the chip exits the Extended Function Mode, it is in the normal running mode and is ready to enter the configuration mode.

Code example for open/close the cash drawer 1/2

```
;----- Enter to extended function mode -----
mov dx, 2eh
mov al, 87h
out dx, al
out dx, al
;----- Select Logical Device 6 of Cash drawer -----
mov al, 07h
out dx, al
inc dx
mov al, 06h
out dx, al
dec dx
;----- Open Cash drawer 1 -----
mov al, 91h
out dx, al
inc dx
in al, dx
and al, FDh
or al, 02h
out dx, al
;----- Close Cash drawer 1 -----
in al, dx
and al, FDh
out dx, al
;----- Open Cash drawer 2 -----
in al, dx
and al, F7h
or al, 08h
out dx, al
;----- Close Cash drawer 2 -----
in al, dx
and al, F7h
out dx, al
;----- Exit the extended function mode -----
dec dx
mov al, 0aah
out dx, al
```

Note:

The DRW2 Port can function only when the optional "Printer Kit" is installed on PA-3122. The DRW2 signals from the printer board (MB-1030, MB-1011, MB-1013, PDAC-3100) can be controlled via relevant commands. The DRW2 port is located on the rear I/O panel as shown below:

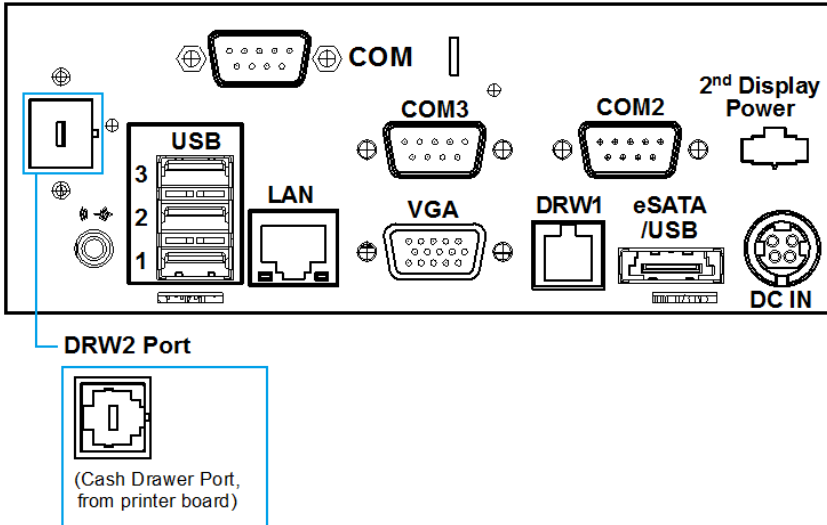

DRW2 Port

PIN	ASSIGNMENT	PIN	ASSIGNMENT
1	GND	4	+24V
2	Drawer Open	5	NC
3	Drawer Sense	6	GND

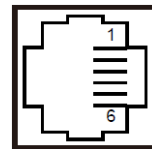

DRW2

Control Codes	Hexadecimal Codes	Function
<DLE EOT>	10 04	Real-time status transmission
<DLE DC4>	10 14	Real-time output of the specified pulse

2-2-7. Cash Drawer Power Selection

JP29: Cash Drawer power selection

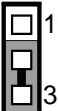
SELECTION	JUMPER SETTING	JUMPER ILLUSTRATION
+24V	1-2	 <p>JP29</p>
+12V	2-3	 <p>JP29</p>

Note: Manufacturing Default is +12V.

Caution:

1. The voltage of the external cash drawer port DRW1 is adjustable via BIOS or the corresponding jumper JP29. Either way **cannot** be applied simultaneously in case of system error, component damage or serious boot failure. That is, JP29 will be enabled if DRW1 is disabled on BIOS.
2. There is no pin connection for JP29 by default. Refer to the *Voltage Adjustment Configuration* in chapter 3 for detailed BIOS setting (BIOS default at 12V).

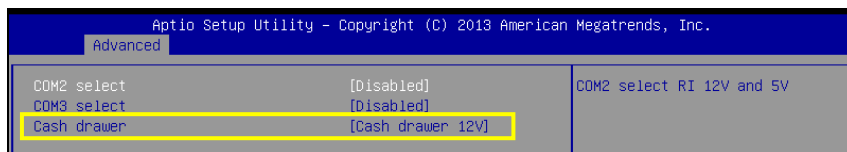

2-2-8. USB Connector

USB1, USB2, USB6, USB7: USB 2.0 connector

PIN	ASSIGNMENT
1	5V (Maximum current: 0.5A)
2	D-
3	D+
4	GND
5	GND

Note: USB1 would be used when jumpers JP14 & JP15 are set as 1-2 (short) connected.

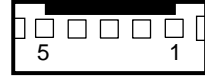

**USB1/
USB2/
USB7**

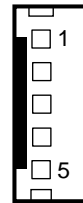

USB6

2-2-9. LED Connector

LED1-1: Power indication LED connector

PIN	ASSIGNMENT
1	GND
2	PWR_LED

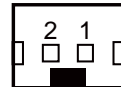

LED1-1

2-2-10. Power Connector

DC12V_PWR1: DC 12Voltage Provider Connector

PIN	ASSIGNMENT
1	VCC12
2	GND
3	VCC12

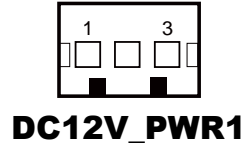

DC5V_PWR1: DC 5Voltage Provider Connector

PIN	ASSIGNMENT
1	5V
2	GND

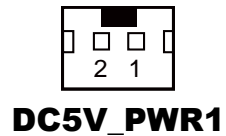

2-2-11. Power for Thermal Printer Connector

PRT_PWR1: Power for Thermal Printer Connector

PIN	ASSIGNMENT
1	VCC24SB
2	VCC24SB
3	GND
4	GND

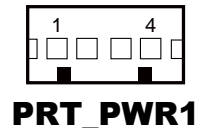

2-2-12. External Speaker Connector

SPK1: External speaker connector

PIN	ASSIGNMENT
1	SPK_GND
2	SPK_OUT

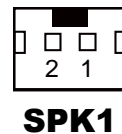

2-2-13. Inverter Connector

JINV4: Inverter connectors

PIN	ASSIGNMENT
1	+12V
2	+12V
3	GND
4	BRCTR
5	GND
6	LVDS_BKLTEN

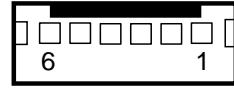

JINV4

2-2-14. LED Backlight Power Control Selection

JP12: LED backlight power control connectors

(for LED backlight panel without power driver built-in)

SELECTION	JUMPER SETTING	JUMPER ILLUSTRATION
On	1-3 2-4	<p>JP12</p>
Off	3-5 4-6	<p>JP12</p>

Note: Manufacturing Default is LED.

2-2-15. LED Backlight Power Connector

JINVDRV1: LED backlight power connector

PIN	ASSIGNMENT
1	VCC
2	GND

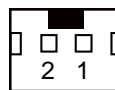

JINVDRV1

Note: JINVDRV1 will not function when JP38 & JP39 are set as “RS-232” interface.

2-2-16. Panel Resolution Selection

JP8, JP9: Panel resolution control connectors

SELECTION	JUMPER SETTING	JUMPER ILLUSTRATION	
15” 1024 x 768 (24 bit)	JP8: 1-3, 4-6 JP9: 3-5, 4-6	<p>JP8</p>	<p>JP9</p>
10.4” 1024 x 768 (18 bit)	JP8: 3-5, 2-4 JP9: 3-5, 4-6	<p>JP8</p>	<p>JP9</p>
10.4” 800 x 600 (18bit)	JP8: 3-5, 4-6 JP9: 3-5, 4-6	<p>JP8</p>	<p>JP9</p>

Note: Manufacturing Default is 10.4”, 1024 x 768 (18bit).

2-2-17. LVDS Connector

LVDS1: LVDS Connector

PIN	ASSIGNMENT	PIN	ASSIGNMENT
1	LVDS_VCC	16	LVDS_CLKA_D+
2	GND	17	VDS_CLKA_D-
3	NC	18	GND
4	NC	19	LVDS_A2_D+
5	GND	20	LVDS_A2_D-
6	LVDS_B2_D-	21	GND
7	LVDS_B2_D+	22	LVDS_A1_D+
8	GND	23	LVDS_A1_D-
9	LVDS_B1_D-	24	GND
10	LVDS_B1_D+	25	LVDS_A0_D+
11	LVDS_B3_D+	26	LVDS_A0_D-
12	LVDS_B3_D-	27	LVDS_A3_D+
13	LVDS_B0_D+	28	LVDS_A3_D-
14	LVDS_B0_D-	29	LVDS_VCC
15	GND	30	LVDS_VCC

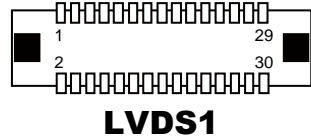

2-2-18. Touch Panel Connector

TOUCH3: Touch panel connectors







PIN	ASSIGNMENT	PIN	ASSIGNMENT
1	LR (Low Right)	4	UR (Up Right)
2	LL (Low Left)	5	UL (Up Left)
3	Probe		

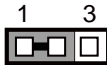

TOUCH3

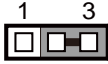
2-2-19. Touch Panel Signal Interface Selection

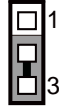
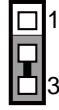
JP14, JP15, JP38, JP39: Control connectors for touch panel signal interface

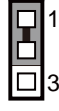
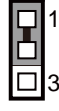

SELECTION	JUMPER SETTING	JUMPER ILLUSTRATION			
USB1 Connector	JP14: 1-2 JP15: 1-2 JP38: 2-3 JP39: 2-3	 JP14	 JP15	 JP38	 JP39
USB Interface	JP14: 2-3 JP15: 2-3 JP38: 2-3 JP39: 2-3	 JP14	 JP15	 JP38	 JP39
RS-232 Interface	JP14: 1-2 JP15: 1-2 JP38: 1-2 JP39: 1-2	 JP14	 JP15	 JP38	 JP39

Note: 1. Manufacturing Default is USB.

2. The COM2 & COM2-1 connector will not function when JP38 & JP39 are set as 1-2 connected.
3. USB1 connector when JP14 & JP15 are set as 1-2 connected.

2-2-20. Clear CMOS Data Selection

JP3: Clear CMOS data selection

SELECTION	JUMPER SETTING	JUMPER ILLUSTRATION
Normal	Open	 JP3
Clear CMOS*	1-2	 JP3

Note: Manufacturing Default is Normal.

*To clear CMOS data, you must power-off the computer and set the jumper to “Clear CMOS” as illustrated above. After five to six seconds, set the jumper back to “Normal” and power-on the computer.

2-2-21. MSR/Card Reader Connector

PS/2_2: MSR/Card reader connectors

PIN	ASSIGNMENT
1	KB_CLK (Output)
2	KB_CLK_C (Input)
3	KB_DATA_C (Input)
4	KB_DATA (Output)
5	+5V
6	GND

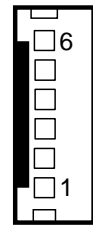

PS/2_2

2-2-22. SATA & SATA Power Connector

SATA1, SATA2: Serial ATA connectors

PIN	ASSIGNMENT	PIN	ASSIGNMENT
1	G1	5	RX-
2	TX+	6	RX+
3	TX-	7	G3
4	G2		

Note: SATA1 only supports the optional RAID function on board.



**SATA1/
SATA2**

JPWR_4P1, JPWR_4P2: Serial ATA power connectors

PIN	ASSIGNMENT
1	VCC
2	GND
3	GND
4	VCC12

Note: JPWR_4P1 only supports the optional RAID function on board.

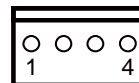

**JPWR_4P1/
JPWR_4P2**

2-2-23. Printer Connector

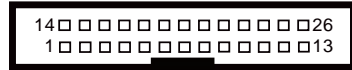

LPT1: Printer connector

LPT1

PIN	ASSIGNMENT	PIN	ASSIGNMENT
1	STBJ	14	ALFJ
2	PDR0	15	ERRJ
3	PDR1	16	PAR_INITJ
4	PDR2	17	SLCTINJ
5	PDR3	18	GND
6	PDR4	19	GND
7	PDR5	20	GND
8	PDR6	21	GND
9	PDR7	22	GND
10	ACKJ	23	GND
11	BUSY	24	GND
12	PE	25	GND
13	SLCTJ	26	NC

2-2-24. Mini-PCle / mSATA Connector

SLOT1: Mini-PCle connector, not support USB function

PIN	ASSIGNMENT	PIN	ASSIGNMENT
1	WAKE#	27	GND
2	+3.3V	28	+1.5V
3	Reserved	29	GND
4	GND	30	SMB_CLK
5	Reserved	31	PETn2
6	+1.5V	32	SMB_DATA
7	CLKREQ#	33	PETp2
8	Reserved	34	GND
9	GND	35	GND
10	Reserved	36	NC
11	REFCLK1-	37	GND
12	Reserved	38	NC
13	REFCLK1+	39	+3.3V
14	Reserved	40	GND
15	GND	41	+3.3V
16	Reserved	42	Reserved
17	Reserved	43	GND
18	GND	44	Reserved
19	Reserved	45	NC
20	Reserved	46	Reserved
21	GND	47	NC
22	PERST#	48	+1.5V
23	PERn2	49	NC
24	+3.3SB	50	GND
25	PERp2	51	Reserved
26	GND	52	+3.3V

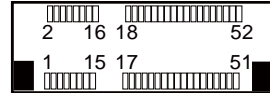

SLOT1

SLOT2: Mini-PCIe or mSATA connector, support USB function

PIN	ASSIGNMENT	PIN	ASSIGNMENT
1	WAKE#	27	GND
2	+3.3V	28	+1.5V
3	Reserved	29	GND
4	GND	30	SMB_CLK
5	Reserved	31	PETn0/SATA1_TX-
6	+1.5V	32	SMB_DATA
7	CLKREQ#	33	PETp0/SATA1_TX+
8	Reserved	34	GND
9	GND	35	GND
10	Reserved	36	USB_D-
11	REFCLK0-	37	GND
12	Reserved	38	USB_D+
13	REFCLK0+	39	+3.3V
14	Reserved	40	GND
15	GND	41	+3.3V
16	Reserved	42	Reserved
17	Reserved	43	GND
18	GND	44	Reserved
19	Reserved	45	NC
20	Reserved	46	Reserved
21	GND	47	NC
22	PERST#	48	+1.5V
23	PERn0/SATA1_RX+	49	NC
24	+3.3SB	50	GND
25	PERp0/SATA1_RX-	51	Reserved
26	GND	52	+3.3V

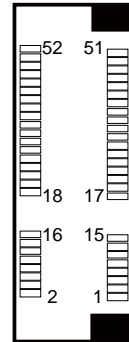

SLOT2

2-3. PRINTER BOARD COMPONENT LOCATIONS & PIN ASSIGNMENT

2-3-1. Printer Board: PDAC-3100

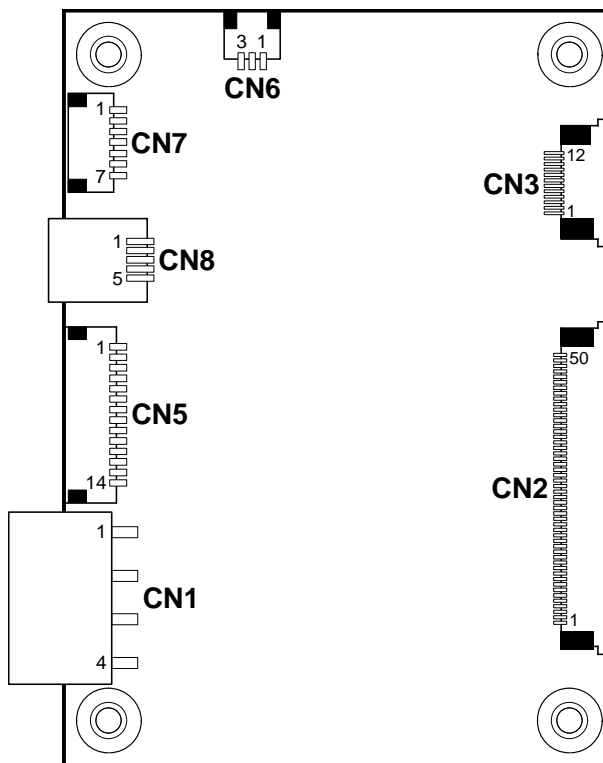

PDAC-3100 Printer Board Component Locations

2-3-1-1. Power Supply Connector

CN1: Power supply wafer

PIN	ASSIGNMENT
1	+24V
2	+24V
3	GND
4	GND

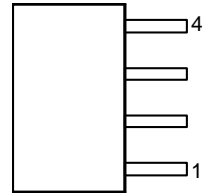

CN1

2-3-1-2. RS-232 Interface Connector

CN7: RS-232 interface connector

PIN	ASSIGNMENT	PIN	ASSIGNMENT
1	TXD	5	DTR
2	RXD	6	DSR
3	RTS	7	GND
4	CTS		

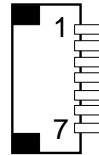

CN7

2-3-1-3. Auto-Cutter Connector

CN3: Auto-cutter wafer

PIN	ASSIGNMENT	FUNCTION
1	NC	Unused
2	Vcs	Power supply of the home position sensor
3	GND	GND of the home position sensor
4	CUTS	Signal of the hom position sensor
5	2B-1	Auto-cutter motor drive signal
6	2B-2	Auto-cutter motor drive signal
7	2A-1	Auto-cutter motor drive signal
8	2A-2	Auto-cutter motor drive signal
9	1B-1	Auto-cutter motor drive signal
10	1B-2	Auto-cutter motor drive signal
11	1A-1	Auto-cutter motor drive signal
12	1A-2	Auto-cutter motor drive signal

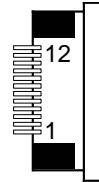

CN3

2-3-1-4. USB Connector

CN8: USB Connector

PIN	ASSIGNMENT	PIN	ASSIGNMENT
1	Vbus	4	NC
2	D-	5	GND
3	D+		

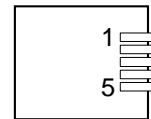

CN8

2-3-1-5. Thermal Head/Motor/Sensor Connector

CN2: Thermal head/motor/sensor connector

PIN	ASSIGNMENT	FUNCTION
1	24V	Head drive power
2	24V	Head drive power
3	24V	Head drive power
4	24V	Head drive power
5	24V	Head drive power
6	24V	Head drive power
7	DAT	Print data output
8	CLK	Synchronizing signal for print data transfer
9	GND	Head GND
10	GND	Head GND
11	GND	Head GND
12	GND	Head GND
13	GND	Head GND
14	GND	Head GND
15	NC	Unused
16	DST4	Head strobe signal
17	DST3	Head strobe signal
18	3.3V	Logic Power
19	GND	Thermistor GND
20	GND	Thermistor GND
21	TH	Thermistor signal
22	NC	Unused
23	DST2	Head strobe signal
24	DST1	Head strobe signal
25	GND	Head GND
26	GND	Head GND
27	GND	Head GND
28	GND	Head GND
29	GND	Head GND

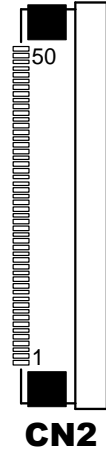

PIN	ASSIGNMENT	FUNCTION
30	GND	Head GND
31	LATCH	Print data latch
32	24V	Head drive power
33	24V	Head drive power
34	24V	Head drive power
35	24V	Head drive power
36	24V	Head drive power
37	24V	Head drive power
38	NC	Unused
39	PS	Signal of the out-of-paper sensor
40	Vps	Power supply of the out-of-paper sensor
41	GND	GND of the platen position/ out-of-paper sensor
42	HS	Signal of the platen position sensor
43	NC	Unused
44	FG	Frame GND
45	FG	Frame GND
46	NC	Unused
47	2A	Motor drive signal
48	1B	Motor drive signal
49	1A	Motor drive signal
50	2B	Motor drive signal

2-3-1-6. Terminal Assignment Connector

CN5: Terminal assignment connector

PIN	ASSIGNMENT	FUNCTION
1	FEED	Feed signal
2	RESET	Reset signal
3	GND	GND
4	ST1	Status signal
5	ST2	Status signal
6	ST3	Status signal
7	ST4	Status signal
8	GND	GND
9	DRS	Drawer sensor signal
10	DSW	Drawer switch signal
11	Vdu	Drive terminal for the drawer (V _p side)
12	GNDdu	Drive terminal for the drawer (GND side)
13	GND	GND
14	NC	Unused

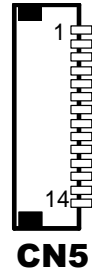

2-3-2. Printer Board: MB-1030

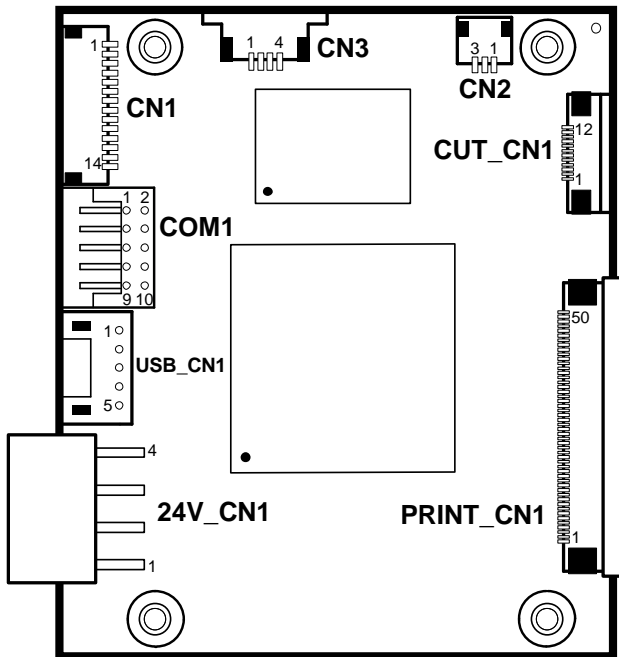

MB-1030 Printer Board Component Locations

2-3-2-1. Power Supply Connector

24V_CN1: Power Supply Wafer

PIN	ASSIGNMENT
1	GND
2	GND
3	+24V
4	+24V

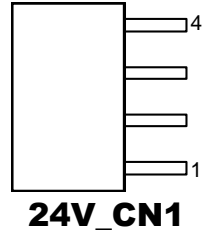

2-3-2-2. RS-232 Interface Connector

COM1: RS-232 Interface Connector

PIN	ASSIGNMENT	PIN	ASSIGNMENT
1	NC	6	DSR /CTS
2	RXD	7	RTS
3	TXD	8	CTS
4	DTR /RTS	9	NC
5	GND	10	NC

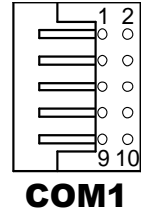

2-3-2-3. Thermal Head/Motor/Sensor Connector

PRINT_CN1: Thermal head/motor/sensor connector

PIN	ASSIGNMENT	FUNCTION
1	24V	Head drive power
2	24V	Head drive power
3	24V	Head drive power
4	24V	Head drive power
5	24V	Head drive power
6	24V	Head drive power
7	DAT	Print data output
8	CLK	Synchronizing signal for print data transfer
9	GND	Head GND
10	GND	Head GND
11	GND	Head GND
12	GND	Head GND
13	GND	Head GND
14	GND	Head GND
15	NC	Unused
16	DST4	Head strobe signal
17	DST3	Head strobe signal
18	3.3V	Logic Power
19	GND	Thermistor GND
20	GND	Thermistor GND
21	TH	Thermistor signal
22	NC	Unused
23	DST2	Head strobe signal
24	DST1	Head strobe signal
25	GND	Head GND
26	GND	Head GND
27	GND	Head GND
28	GND	Head GND
29	GND	Head GND

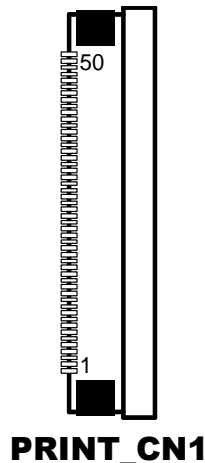

PIN	ASSIGNMENT	FUNCTION
30	GND	Head GND
31	LATCH	Print data latch
32	24V	Head drive power
33	24V	Head drive power
34	24V	Head drive power
35	24V	Head drive power
36	24V	Head drive power
37	24V	Head drive power
38	NC	Unused
39	PS	Signal of the out-of-paper sensor
40	Vps	Power supply of the out-of-paper sensor
41	GND	GND of the platen position/ out-of-paper sensor
42	HS	Signal of the platen position sensor
43	NC	Unused
44	FG	Frame GND
45	FG	Frame GND
46	NC	Unused
47	2A	Motor drive signal
48	1B	Motor drive signal
49	1A	Motor drive signal
50	2B	Motor drive signal

2-3-2-4. Auto-Cutter Connector

CUT_CN1: Auto-cutter Connector

PIN	ASSIGNMENT	FUNCTION
1	NC	Unused
2	Vcs	Power supply of the home position sensor
3	GND	GND of the home position sensor
4	CUTS	Signal of the hom position sensor
5	2B-1	Autocutter motor drive signal
6	2B-2	Autocutter motor drive signal
7	2A-1	Autocutter motor drive signal
8	2A-2	Autocutter motor drive signal
9	1B-1	Autocutter motor drive signal
10	1B-2	Autocutter motor drive signal
11	1A-1	Autocutter motor drive signal
12	1A-2	Autocutter motor drive signal

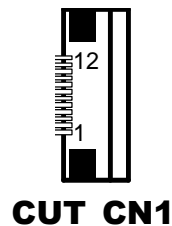

2-3-2-5. Paper-Near-END Sensor Connector

CN2: Paper-near-end sensor connector

PIN	ASSIGNMENT	FUNCTION
1	Vns	Power supply of the near end sensor
2	NS	Signal of the near end sensor
3	GND	GND of the near end sensor



2-3-2-6. USB Interface Connector

USB_CN1: USB interface connector

PIN	ASSIGNMENT	PIN	ASSIGNMENT
1	Vbus	4	GND
2	D-	5	GND
3	D+		

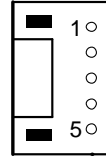

USB_CN1

2-3-2-7. Terminal Assignment Connector

CN1: Terminal assignment connector

PIN	ASSIGNMENT	FUNCTION
1	FEED	Feed signal
2	RESET	Reset signal
3	GND	GND
4	ST1	Status signal
5	ST2	Status signal
6	ST3	Status signal
7	ST4	Status signal
8	GND	GND
9	DRS	Drawer sensor signal
10	DSW	Drawer switch signal
11	Vdu	Drive terminal for the drawer (Vp side)
12	GNDdu	Drive terminal for the drawer (GND side)
13	GND	GND
14	NC	Unused

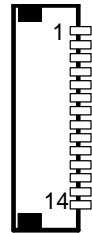

CN1

2-3-3. Printer Board: MB-1011 & MB-1013

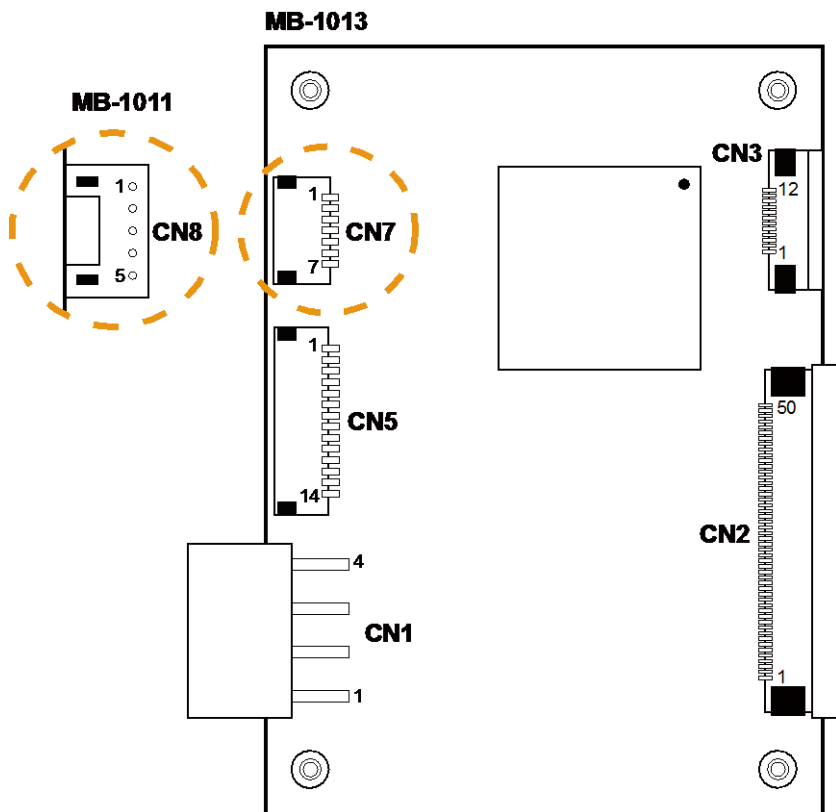

MB-1011 & MB-1013 Printer Board Component Locations

2-3-3-1. Power Supply Connector

CN1: Power supply wafer

PIN	ASSIGNMENT
1	GND
2	GND
3	+24V
4	+24V

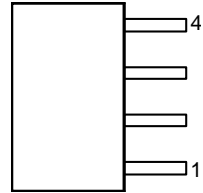

CN1

2-3-3-2. RS-232 Interface Connector

CN7: RS-232 interface connector

PIN	ASSIGNMENT	PIN	ASSIGNMENT
1	TXD	5	DTR
2	RXD	6	DSR
3	RTS	7	GND
4	CTS		

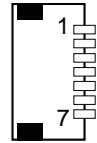

CN7

2-3-3-3. Thermal Head/Motor/Sensor Connector

CN2: Thermal head/motor/sensor connector

PIN	ASSIGNMENT	FUNCTION
1	24V	Head drive power
2	24V	Head drive power
3	24V	Head drive power
4	24V	Head drive power
5	24V	Head drive power
6	24V	Head drive power
7	DAT	Print data output
8	CLK	Synchronizing signal for print data transfer
9	GND	Head GND
10	GND	Head GND
11	GND	Head GND
12	GND	Head GND
13	GND	Head GND
14	GND	Head GND
15	NC	Unused
16	DST4	Head strobe signal
17	DST3	Head strobe signal
18	3.3V	Logic Power
19	GND	Thermistor GND
20	GND	Thermistor GND
21	TH	Thermistor signal
22	NC	Unused
23	DST2	Head strobe signal
24	DST1	Head strobe signal
25	GND	Head GND
26	GND	Head GND
27	GND	Head GND
28	GND	Head GND
29	GND	Head GND

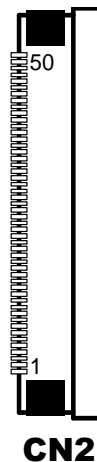

PIN	ASSIGNMENT	FUNCTION
30	GND	Head GND
31	LATCH	Print data latch
32	24V	Head drive power
33	24V	Head drive power
34	24V	Head drive power
35	24V	Head drive power
36	24V	Head drive power
37	24V	Head drive power
38	NC	Unused
39	PS	Signal of the out-of-paper sensor
40	Vps	Power supply of the out-of-paper sensor
41	GND	GND of the platen position/ out-of-paper sensor
42	HS	Signal of the platen position sensor
43	NC	Unused
44	FG	Frame GND
45	FG	Frame GND
46	NC	Unused
47	2A	Motor drive signal
48	1B	Motor drive signal
49	1A	Motor drive signal
50	2B	Motor drive signal

2-3-3-4. Auto-Cutter Connector

CN3: Auto-cutter Connector

PIN	ASSIGNMENT	FUNCTION
1	NC	Unused
2	Vcs	Power supply of the home position sensor
3	GND	GND of the home position sensor
4	CUTS	Signal of the hom position sensor
5	2B-1	Autocutter motor drive signal
6	2B-2	Autocutter motor drive signal
7	2A-1	Autocutter motor drive signal
8	2A-2	Autocutter motor drive signal
9	1B-1	Autocutter motor drive signal
10	1B-2	Autocutter motor drive signal
11	1A-1	Autocutter motor drive signal
12	1A-2	Autocutter motor drive signal

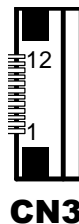

2-3-3-5. USB Interface Connector

CN8: USB interface connector

PIN	ASSIGNMENT
1	Vbus
2	D-
3	D+
4	GND
5	GND

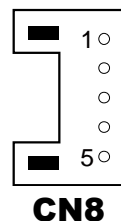

2-3-3-6. Terminal Assignment Connector

CN5: Terminal assignment connector

PIN	ASSIGNMENT	FUNCTION
1	FEED	Feed signal
2	RESET	Reset signal
3	GND	GND
4	ST1	Status signal
5	ST2	Status signal
6	ST3	Status signal
7	ST4	Status signal
8	GND	GND
9	DRS	Drawer sensor signal
10	DSW	Drawer switch signal
11	Vdu	Drive terminal for the drawer (Vp side)
12	GNDdu	Drive terminal for the drawer (GND side)
13	GND	GND
14	NC	Unused

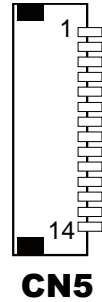

2-4. VFD BOARD COMPONENT LOCATIONS & PIN ASSIGNMENT

2-4-1. VFD Board: MB-4103, LD720

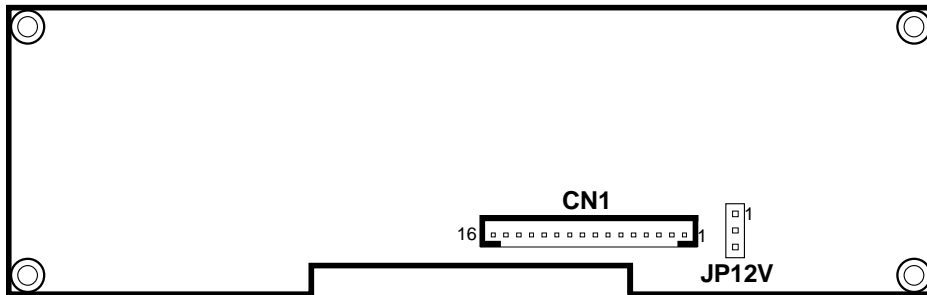

MB-4103 & LD720 VFD Board Component Locations

2-4-1-1. Power Switch Selection

JP12V: Power Switch Selection

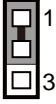
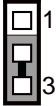
SELECTION	JUMPER SETTING	JUMPER ILLUSTRATION
OFF	1-2	 <p>JP12V</p>
ON	2-3	 <p>JP12V</p>

Note: Manufacturing Default is ON.

2-4-1-2. RS-232 Serial Interface Connector

CN1: RS-232 serial interface wafer

PIN	ASSIGNMENT	PIN	ASSIGNMENT
1	GND	9	NC
2	TXD	10	NC
3	RXD	11	NC
4	DTR	12	NC
5	DSR	13	NC
6	RTS	14	NC
7	CTS	15	NC
8	+12V/+5V	16	NC

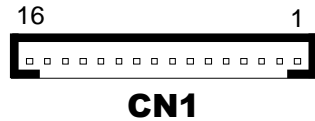

2-5. MSR BOARD COMPONENT LOCATIONS & PIN ASSIGNMENT

2-5-1. ID TECH



ID-TECH MSR Board Component Locations

2-5-1-1. Main Connector

CN:

PIN	ASSIGNMENT	PIN	ASSIGNMENT
1	Chassis Ground	5	K-CLK (Computer connections)
2	P-CLK (Keyboard connections)	6	K-DATA (Computer connections)
3	P-DATA (Keyboard connections)	7	GND
4	+5V Vcc		

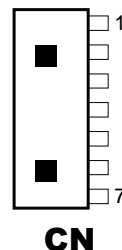

2-5-2. SYSKING

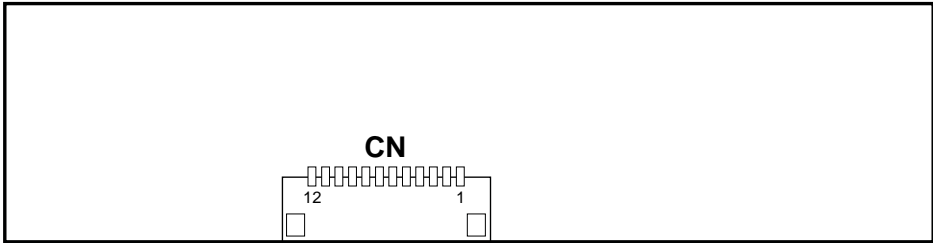

SYSKING MSR Board Component Locations

2-5-2-1. Main Connector

CN:

PIN	ASSIGNMENT	PIN	ASSIGNMENT
1	+5V Vcc	7	NC
2	K-DATA (Host to MSR)	8	NC
3	K-CLK Host to MSR	9	NC
4	P-DATA (MSR to Keyboard)	10	NC
5	P-CLK (MSR to Keyboard)	11	Signal Ground
6	NC	12	Signal Ground

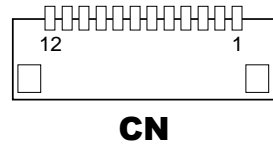

2-5-3. MB-3012



MB-3012 MSR Board Component Locations

2-5-3-1. Information Button Reader

I_BUTTON1: Information button reader

PIN	ASSIGNMENT
1	I_B1
2	GND

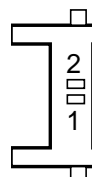

I-BUTTON1

2-5-3-2. Output Connector

IO1: Output wafer

PIN	ASSIGNMENT	PIN	ASSIGNMENT
1	CLK_KB	7	RX_MSR
2	CLK_PC	8	TX_MSR
3	DATA_KB	9	GND
4	DATA_PC	10	USB_D+_R
5	+5V	11	USB_D-_R
6	CHASSIS GND	12	GND

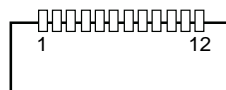

IO1

SOFTWARE

CHAPTER

3

This chapter provides the detailed information of driver utilities and BIOS settings for the system.

The following sections are included:

- Driver
 - Intel® Chipset Software Installation Utility
 - VGA Driver Utility
 - LAN Driver Utility
 - Sound Driver Utility
 - Touchscreen Driver Utility
 - Fingerprinter Driver Utility (Optional)
 - RFID Module Driver (Optional)
 - Wireless Module Driver (Optional)

- Embedded Peripheral Device
 - Printer
 - VFD
 - MSR

- API

- BIOS Operation
 - Setup
 - Watchdog Timer Configuration
 - Update Procedure
 - System Resource Map

3-1. DRIVER

3-1-1. Introduction

Enclosed with the PA-3122 Series package is our driver utilities, which comes in a CD-ROM disc. Refer to the following table for driver locations.

FILENAME (Assume that CD-ROM drive is D:)	PURPOSE
<ul style="list-style-type: none"> ▪ D:\Driver\Platform\POSReady7 (32/64-bit)\Intel TXE Firmware ▪ D:\Driver\Platform\Win8(32/64bit)\Intel TXE Firmware 	Intel® TXE firmware driver
<ul style="list-style-type: none"> ▪ D:\Driver\Platform\POSReady7 (32-bit)\MBI Driver ▪ D:\Driver\Platform\Win8(32/64bit)\MBI Driver 	Intel® MBI driver
<ul style="list-style-type: none"> ▪ D:\Driver\Platform\POSReady7 (32-bit)\Main Chip ▪ D:\Driver\Platform\Win8(32/64bit)\Main Chip 	Intel® chipset software installation utility
<ul style="list-style-type: none"> ▪ D:\Driver\Platform\POSReady7 (32-bit)\VGA ▪ D:\Driver\Platform\Win8(32/64bit)\VGA 	Intel® HD Graphics family for VGA driver installation
<ul style="list-style-type: none"> ▪ D:\Driver\Platform\POSReady7 (32-bit)\LAN ▪ D:\Driver\Platform\Win8(32/64bit)\LAN 	Realtek 8119CG for LAN driver installation
<ul style="list-style-type: none"> ▪ D:\Driver\Platform\POSReady7 (32-bit)\SOUND ▪ D:\Driver\Platform\Win8(32/64bit)\SOUND 	Realtek ALC888 for sound driver installation
<ul style="list-style-type: none"> ▪ D:\Driver\Device. 	Driver installation for touchscreen, embedded printer, MSR, wireless card, & fingerprint
D:\Driver\Flash BIOS	AMI BIOS update utility

Note: Be sure to install the driver utilities right after the OS is fully installed.

3-1-2. Intel® Chipset Software Installation Utility

3-1-2-1. Introduction

The Intel® Chipset Software Installation Utility installs Windows *.INF files to the target system. These files outline to the operating system how to configure the Intel chipset components in order to ensure the following features function properly:

- SATA Storage Support (SATA & SATA II)
- USB Support (1.1 & 2.0)
- Identification of Intel® Chipset Components in Device Manager

3-1-2-2. Installation of Intel® Chipset Driver

The utility pack is to be installed only for POSReady 7 & Embedded 8 Industry series, and it should be installed right after the OS installation. Please follow the steps below:

1. Connect the USB CD-ROM device to PA-3122 and insert the driver disk.
2. Enter the “Main Chip” folder where the Chipset driver is located (depending on your OS platform).
3. Click **Setup.exe** file for driver installation.
4. Follow the on-screen instructions to complete the installation.
5. Once the installation is completed, shut down the system and restart PA-3122 for the changes to take effect.

3-1-3. VGA Driver Utility

The VGA interface embedded with PA-3122 can support a wide range of display types. You can have dual displays via CRT & LVDS interfaces work simultaneously.

3-1-3-1. Installation of VGA Driver

To install the Graphics driver, follow the steps below:

1. Connect the USB CD-ROM device to PA-3122 and insert the driver disk.
2. Enter the “VGA” folder where the VGA driver is located (depending on your OS platform).
3. Click **Setup.exe** file for driver installation.
4. Follow the on-screen instructions to complete the installation.
5. Once the installation is completed, shut down the system and restart PA-3122 for the changes to take effect.

3-1-4. LAN Driver Utility

PA-3122 is enhanced with LAN function that can support various network adapters. Installation platform for the LAN driver is listed as follows:

3-1-4-1. Installation of LAN Driver

To install the LAN Driver, follow the steps below:

1. Connect the USB CD-ROM device to PA-3122 and insert the driver disk.
2. Enter the “LAN” folder where the LAN driver is located (depending on your OS platform).
3. Click **Setup.exe** file for driver installation.
4. Follow the on-screen instructions to complete the installation.
5. Once the installation is completed, shut down the system and restart PA-3122 for the changes to take effect.

For more details on the Installation procedure, please refer to the Readme.txt file found on LAN Driver Utility.

3-1-5. Sound Driver Utility

The sound function enhanced in this system is fully compatible with Windows POSReady 7 & Embedded 8 Industry series. Below, you will find the content of the Sound driver.

3-1-5-1. Installation of Sound Driver

To install the Sound Driver, follow the steps below:

1. Connect the USB CD-ROM device to PA-3122 and insert the driver disk.
2. Enter the “Sound” folder where the sound driver is located (depending on your OS platform).
3. Click **Setup.exe** file for driver installation.
4. Follow the on-screen instructions to complete the installation.
5. Once the installation is completed, shut down the system and restart PA-3122 for the changes to take effect.

3-1-6. Touchscreen Driver Utility

The touchscreen driver utility can only be installed on Windows POSReady 7 & Embedded 8 Industry series, and it should be installed right after the OS installation.

3-1-6-1. Installation of Touchscreen Driver

To install the touchscreen driver, follow the steps below:

1. Connect the USB CD-ROM device to PA-3122 and insert the driver disk.
2. Enter the “Device\Touch Screen” folder where the touchscreen driver is located.
3. Click **Setup.exe** file for driver installation.
4. Follow the on-screen instructions to complete the installation.
5. Once the installation is completed, shut down the system and restart PA-3122 for the changes to take effect.

3-1-7. Fingerprinter Driver Utility (Optional)

The fingerprinter driver utility can only be installed on a Windows platform, and it should be installed right after the OS installation.

3-1-7-1. Installation of Fingerprinter Driver

To install the fingerprinter driver, follow the steps below:

1. Connect the USB CD-ROM device to PA-3122 and insert the driver disk.
2. Enter the “Device\Embedded Finger Printer” folder where the fingerprinter driver is located.
3. Click **Setup.exe** file for driver installation.
4. Follow the on-screen instructions to complete the installation.
5. Once the installation is completed, shut down the system and restart PA-3122 for the changes to take effect.

3-1-8. RFID Module Driver Utility (Optional)

The RFID driver utility can only be installed on Windows POSReady7 & Embedded 8 industry series, and it should be installed right after the OS installation.

3-1-8-1. Installation of RFID Module Driver

To install the RFID module driver, follow the steps below:

1. Connect the USB CD-ROM device to PA-3122 and insert the driver disk.
2. Enter the “Device\RFID Module” folder where the RFID Module driver is located.
3. Click **Autorun.exe** file for driver installation.
4. Select **Mifare Demo Software V1.5R8**.
5. Follow the on-screen instructions to complete the installation.
6. Once the installation is completed, shut down the system and restart PA-3122 for the changes to take effect.

3-1-9. Wireless Module Driver Utility (Optional)

The wireless driver utility can only be installed on Windows POSReady7 & Embedded 8 Industry series, and it should be installed right after the OS installation.

3-1-9-1. Installation of Wireless Driver

To install the wireless driver, follow the steps below:

1. Connect the USB CD-ROM device to PA-3122 and insert the driver disk.
2. Enter the “Device\Embedded Wireless Module” folder where the wireless driver is located.
3. Click **Setup.exe** file for driver installation.
4. Follow the on-screen instructions to complete the installation.
5. Once the installation is completed, shut down the system and restart PA-3122 for the changes to take effect.

3-2. EMBEDDED PERIPHERAL DEVICES

Command lists and driver installation guide for embedded peripheral devices of the system - printer board, VFD and MSR – are explicitly included in this section.

3-2-1. Printer Board: MB-1030

3-2-1-1. Command List

1. Printer Registry Operation

Registry path: [HKEY_LOCAL_MACHINE\SOFTWARE\OLEforRetail\ServiceOPOS\PosPrinter\MB1030]

Registry Name	Default Data	Notes
Default Value	MB1030 OPOS.MB1030.1	-
BaudRate	115200	-
BitLength	8	-
Parity	0	-
Port	COM4	-
Stop	1	-

2. POS Printer Service Object and Method Relations

Method	Status of support	Notes
Open	○	-
Close	○	-
ClaimDevice	○	-
ReleaseDevice	○	-
Enable	○	-
Disable	○	-
CheckHealth	○	-
PrintNormal	○	-
PrintBarCode	○	-
PrintBitmap	○	-
RotatePrint	○	only support 180°
CutPaper	○	-

3-2-1-2. OPOS Printer Driver

The **MB1030_OposSetup.exe** program sets up the registry information of MSRHK reader for OPOS program uses.

1. Installation

Below steps guide you to install the **MB1030_OposSetup** program.

- Run the setup file **MB1030_OposSetup.exe** located in the Software folder of CD.
- This setup also installs the **MB1030** program.
- Follow the wizard instructions to complete the installation.

2. Launching Program

Below steps guide you to load the **MB1030** program.

- Click *POSPrinter* folder from the path *Start\Programs\Protech OPOS*.
- Click **MB1030** to launch the program.

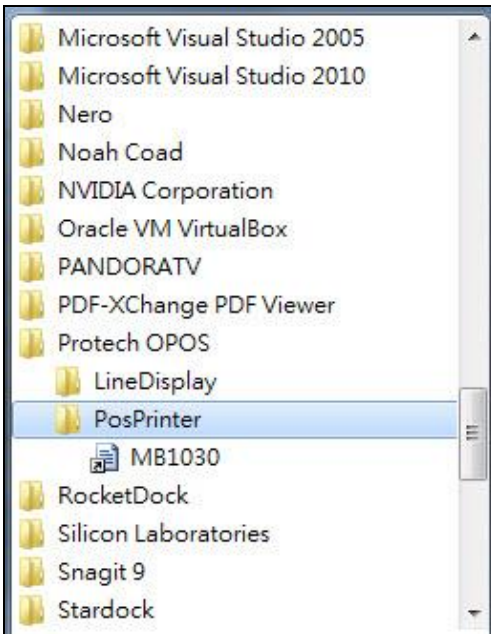

3. OPOS Control Object of MB1030 Program

a.) Print tab buttons:

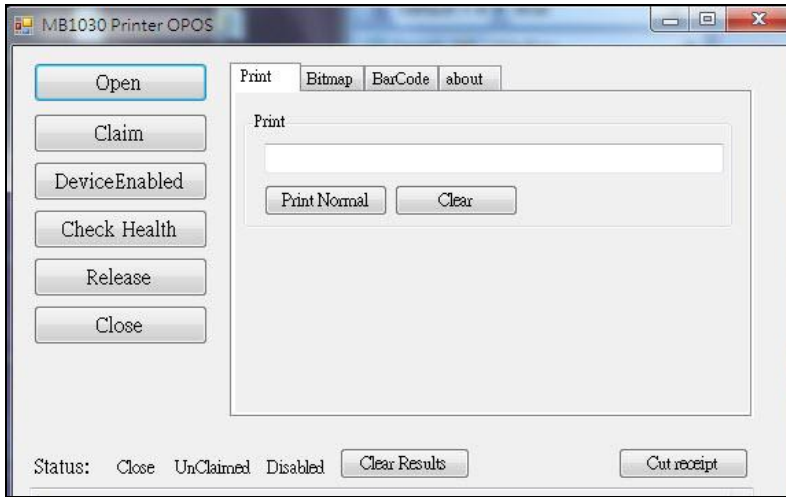

Button/Item	Description
Printer Normal	Print the string.

b.) Bitmap tab buttons/items:

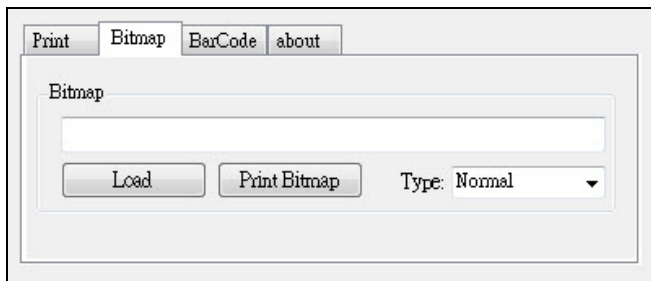

Button/Item	Description
Load	Load bitmap file.
Print Bitmap	Print bitmap file.
Type	Normal or Rotate 108°.

c.) BarCode tab buttons/items:

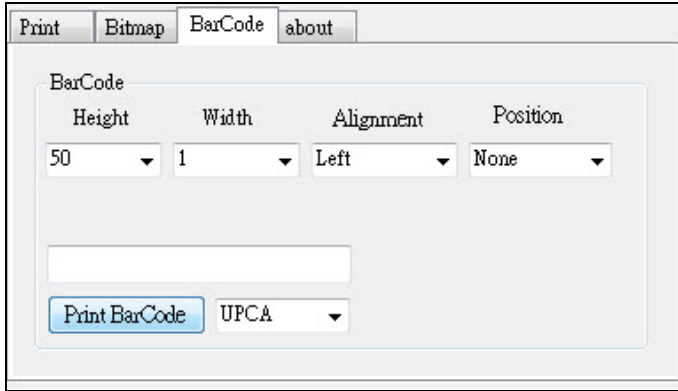

Button/Item	Description
Print BarCode	Print the barcode. Supported barcode types: UPCA, UPCE, EAN8, EAN13, ITF, Codabar, Code39, Code93, Code128
Alignment	Left, center or right
Position	Print barcode number (None, Above or Below)

4. MB1030 type

Key Name	Type	Default Value	Note
BaudRate	String	115200	UART Baud Rate (default)
BitLength	String	8	UART Data Bit (default)
Parity	String	0	UART Parity Bit (default)
Port	String	COM4	UART Port (default)
Stop	String	1	UART Stop Bit (default)

5. OPOS APIs Support List

	Category Type	Name	Mutability	OPOS APG Version	Printer .SO
Properties	common bool	AutoDisable	R/W	1.2	Not Applicable
Properties	common long	BinaryConversion	R/W	1.2	Not Applicable
Properties	common long	CapPowerReporting	Read only	1.3	Not Applicable
Properties	common string	CheckHealthText	Read only	1.0	Supported
Properties	common bool	Claimed	Read only	1.0	Supported
Properties	common long	DataCount	Read only	1.2	Not Applicable
Properties	common bool	DataEventEnabled	Read only	1.0	Not Applicable
Properties	common bool	DeviceEnabled	R/W	1.0	Not Applicable
Properties	common bool	FreezeEvents	R/W	1.0	Supported
Properties	common long	OpenResult	Read only	1.5	Supported
Properties	common bool	OutputID	Read only	1.0	Not Applicable
Properties	common bool	PowerNotify	R/W	1.3	Not Applicable
Properties	common bool	PowerState	Read only	1.3	Not Applicable
Properties	common long	ResultCode	Read only	1.0	Supported
Properties	common long	ResultCodeExtended	Read only	1.0	Not Applicable
Properties	common long	State	Read only	1.0	Supported
Properties	common string	ControlObject Description	Read only	1.0	Not Applicable
Properties	common long	ControlObject Version	Read only	1.0	Not Applicable
Properties	common string	ServiceObject Description	Read only	1.0	Supported
Properties	common long	ServiceObject Version	Read only	1.0	Supported
Properties	common string	DeviceDescription	Read only	1.0	Supported
Properties	common string	ControlObject Description	Read only	1.0	Not Applicable
Properties	specific long	CapCharacterSet	Read only	1.1	Not Applicable
Pro.perties	specific bool	CapConcurrentJrnRec	Read only	1.0	Not Applicable
Properties	specific bool	CapConcurrentJrnSlp	Read only	1.0	Not Applicable
Properties	specific bool	CapCoverSensor	Read only	1.0	Not Applicable
Properties	specific bool	CapTransaction	Read only	1.1	Not Applicable
Properties	specific bool	CapJrnPresent	Read only	1.0	Not Applicable
Properties	specific bool	CapJrn2Color	Read only	1.0	Not Applicable
Properties	specific bool	CapJrnBold	Read only	1.0	Not Applicable

	Category Type	Name	Mutability	OPOS APG Version	Printer .SO
Properties	specific long	CapJrnCartridgeSensor	Read only	1.5	Not Applicable
Properties	specific long	CapJrnColor	Read only	1.5	Not Applicable
Properties	specific long	CapJrnDhigh	Read only	1.0	Not Applicable
Properties	specific long	CapJrnDwide	Read only	1.0	Not Applicable
Properties	specific long	CapJrnDwideDhigh	Read only	1.0	Not Applicable
Properties	specific long	CapJrnEmptySensor	Read only	1.0	Not Applicable
Properties	specific long	CapJrnItalic	Read only	1.0	Not Applicable
Properties	specific long	CapJrnNearEndSensor	Read only	1.0	Not Applicable
Properties	specific bool	CapJrnUnderline	Read only	1.0	Not Applicable
Properties	specific bool	CapRecPresent	Read only	1.0	Not Applicable
Properties	specific bool	CapRec2Color	Read only	1.0	Not Applicable
Properties	specific bool	CapRecBarCode	Read only	1.0	Not Applicable
Properties	specific bool	CapRecBitmap	Read only	1.0	Not Applicable
Properties	specific bool	CapRecBold	Read only	1.0	Not Applicable
Properties	specific long	CapRecCartridgeSensor	Read only	1.5	Not Applicable
Properties	specific long	CapRecColor	Read only	1.5	Not Applicable
Properties	specific bool	CapRecDhigh	Read only	1.0	Not Applicable
Properties	Specific bool	CapRecDwide	Read only	1.0	Not Applicable
Properties	specific bool	CapRecDwideDhigh	Read only	1.0	Not Applicable
Properties	specific bool	CapRecEmptySensor	Read only	1.0	Not Applicable
Properties	specific bool	CapRecItalic	Read only	1.0	Not Applicable
Properties	specific bool	CapRecLeft90	Read only	1.0	Not Applicable
Properties	specific bool	CapRecMarkFeed	Read only	1.5	Not Applicable
Properties	specific bool	CapRecNearEndSensor	Read only	1.0	Not Applicable
Properties	specific bool	CapRecPapercut	Read only	1.0	Not Applicable
Properties	specific bool	CapRecRight90	Read only	1.0	Not Applicable
Properties	specific bool	CapRecRotate180	Read only	1.0	Not Applicable
Properties	specific bool	CapRecStamp	Read only	1.0	Not Applicable
Properties	specific bool	CapRecUnderline	Read only	1.0	Not Applicable
Properties	specific bool	CapSlpPresent	Read only	1.0	Not Applicable
Properties	specific bool	CapSlpFullslip	Read only	1.0	Not Applicable
Properties	specific bool	CapSlp2Color	Read only	1.0	Not Applicable
Properties	specific bool	CapSlpBarCode	Read only	1.0	Not Applicable
Properties	specific bool	CapSlpBitmap	Read only	1.0	Not Applicable
Properties	specific bool	CapSlpBold	Read only	1.0	Not Applicable
Properties	specific bool	CapSlpBothSidesPrint	Read only	1.5	Not Applicable

	Category Type	Name	Mutability	OPOS APG Version	Printer .SO
Properties	specific long	CapSlpCartridgeSensor	Read only	1.5	Not Applicable
Properties	specific long	CapSlpColor	Read only	1.5	Not Applicable
Properties	specific bool	CapSlpDhigh	Read only	1.0	Not Applicable
Properties	specific bool	CapSlpDwide	Read only	1.0	Not Applicable
Properties	specific bool	CapSlpDwideDhigh	Read only	1.0	Not Applicable
Properties	specific bool	CapSlpEmptySensor	Read only	1.0	Not Applicable
Properties	specific bool	CapSlpItalic	Read only	1.0	Not Applicable
Properties	specific bool	CapSlpLeft90	Read only	1.0	Not Applicable
Properties	specific bool	CapSlpNearEndSensor	Read only	1.0	Not Applicable
Properties	specific bool	CapSlpRight90	Read only	1.0	Not Applicable
Properties	specific bool	CapSlpRotate180	Read only	1.0	Not Applicable
Properties	specific bool	CapSlpUnderline	Read only	1.0	Not Applicable
Properties	specific bool	AsyncMode	R/W	1.0	Not Applicable
Properties	specific long	CartridgeNotify	R/W	1.5	Not Applicable
Properties	specific long	CharacterSet	R/W	1.0	Not Applicable
Properties	specific string	CharacterSetList	Read only	1.0	Not Applicable
Properties	specific bool	CoverOpen	Read only	1.0	Not Applicable
Properties	specific long	ErrorLevel	Read only	1.1	Not Applicable
Properties	specific long	ErrorStation	Read only	1.0	Not Applicable
Properties	specific string	ErrorString	Read only	1.1	Not Applicable
Properties	specific string	FontTypefaceList	Read only	1.1	Not Applicable
Properties	specific bool	FlagWhenIdle	R/W	1.0	Not Applicable
Properties	specific long	MapMode	R/W	1.0	Not Applicable
Properties	specific long	RotateSpecial	R/W	1.1	Not Applicable
Properties	specific long	JrnLineChars	R/W	1.0	Not Applicable
Properties	specific string	JrnLineCharsList	Read only	1.0	Not Applicable
Properties	specific long	JrnLineHeight	R/W	1.0	Not Applicable
Properties	specific long	JrnLineSpacing	R/W	1.0	Not Applicable
Properties	specific long	JrnLineWidth	Read only	1.0	Not Applicable
Properties	specific bool	JrnLetterQuality	R/W	1.0	Not Applicable
Properties	specific bool	JrnEmpty	Read only	1.0	Not Applicable
Properties	specific bool	JrnNearEnd	Read only	1.0	Not Applicable
Properties	specific long	JrnCartridgeState	Read only	1.5	Not Applicable
Properties	specific long	JrnCurrentCartridge	R/W	1.5	Not Applicable
Properties	specific long	RecLineChars	R/W	1.0	Not Applicable
Properties	specific string	RecLineCharsList	Read only	1.0	Not Applicable

	Category Type	Name	Mutability	OPOS APG Version	Printer .SO
Properties	specific long	RecLineHeight	R/W	1.0	Not Applicable
Properties	specific long	RecLineSpacing	R/W	1.0	Not Applicable
Properties	specific long	RecLineWidth	Read only	1.0	Not Applicable
Properties	specific bool	RecLetterQuality	R/W	1.0	Not Applicable
Properties	specific bool	RecEmpty	Read only	1.0	Not Applicable
Properties	specific bool	RecNearEnd	Read only	1.0	Not Applicable
Properties	specific long	RecSidewaysMaxLines	Read only	1.0	Not Applicable
Properties	specific long	RecSidewaysMaxChars	Read only	1.0	Not Applicable
Properties	specific long	RecLinesToPaperCut	Read only	1.0	Not Applicable
Properties	specific string	RecBarCodeRotationList	Read only	1.1	Not Applicable
Properties	specific long	RecCartridgeState	Read only	1.5	Not Applicable
Properties	specific long	RecCurrentCartridge	R/W	1.5	Not Applicable
Properties	specific long	SlpLineChars	R/W	1.0	Not Applicable
Properties	specific string	SlpLineCharsList	Read only	1.0	Not Applicable
Properties	specific long	SlpLineHeight	R/W	1.0	Not Applicable
Properties	specific long	SlpLineSpacing	R/W	1.0	Not Applicable
Properties	specific long	SlpLineWidth	Read only	1.0	Not Applicable
Properties	specific bool	SlpLetterQuality	R/W	1.0	Not Applicable
Properties	specific bool	SlpEmpty	Read only	1.0	Not Applicable
Properties	specific bool	SlpNearEnd	Read only	1.0	Not Applicable
Properties	specific long	SlpSidewaysMaxLines	Read only	1.0	Not Applicable
Properties	specific long	SlpSidewaysMaxChars	Read only	1.0	Not Applicable
Properties	specific long	SlpMaxLines	Read only	1.0	Not Applicable
Properties	specific long	SlpLinesNearEndToEnd	Read only	1.0	Not Applicable
Properties	specific string	SlpBarCodeRotationList	Read only	1.1	Not Applicable
Properties	specific long	SlpPrintSide	Read only	1.5	Not Applicable
Properties	specific long	SlpCartridgeState	Read only	1.5	Not Applicable
Properties	specific long	SlpCurrentCartridge	R/W	1.5	Not Applicable
Methods	common	Open	-	1.0	Supported
Methods	common	Close	-	1.0	Supported
Methods	common	Claim	-	1.0	Supported
Methods	common	ClaimDevice	-	1.0	Supported
Methods	common	Release	-	1.0	Supported
Methods	common	ReleaseDevice	-	1.0	Supported
Methods	common	CheckHealth	-	1.0	Supported
Methods	common	ClearInput	-	1.0	Not Applicable

	Category Type	Name	Mutability	OPOS APG Version	Printer .SO
Methods	common	ClearOutput	-	1.0	Not Applicable
Methods	common	DirectIO	-	1.0	Not Applicable
Methods	specific	PrintNormal	-	1.0	Supported
Methods	specific	PrintTwoNormal	-	1.0	Not Applicable
Methods	specific	PrintImmediate	-	1.0	Not Applicable
Methods	specific	BeginInsertion	-	1.0	Not Applicable
Methods	specific	EndInsertion	-	1.0	Not Applicable
Methods	specific	BeginRemoval	-	1.0	Not Applicable
Methods	specific	EndRemoval	-	1.0	Not Applicable
Methods	specific	CutPaper	-	1.0	Supported
Methods	specific	RotatePrint	-	1.0	Supported (only 180)
Methods	specific	PrintBarCode	-	1.0	Supported
Methods	specific	PrintBitmap	-	1.0	Supported
Methods	specific	TransactionPrint	-	1.1	Not Applicable
Methods	specific	ValidateData	-	1.1	Not Applicable
Methods	specific	SetBitmap	-	1.0	Not Applicable
Methods	specific	SetLogo	-	1.0	Not Applicable
Methods	specific	ChangePrintSide	-	1.5	Not Applicable
Methods	specific	MarkFeed	-	1.5	Not Applicable
Events	common	DataEvent	-	1.0	Not Applicable
Events	common	DirectIOEvent	-	1.0	Not Applicable
Events	common	ErrorEvent	-	1.0	Not Applicable
Events	common	OutputComplete Event	-	1.0	Not Applicable
Events	common	StatusUpdate Event	-	1.0	Not Applicable

3-2-2. VFD: MB-4103 (RS-232)

3-2-2-1. Command List

1. VFD Registry Operation

Registry Path: [HKEY_LOCAL_MACHINE\SOFTWARE\OLEforRetail\ServiceOPOS\LineDisplay\Prox-PMP4000]

Registry Name	Default Data	Notes
Default Value	LineDisplay.PMP4000.1	-
BaudRate	9600	-
BitLength	8	-
Parity	0	-
Port	COM1	-
Stop	1	-

2. OPOS VFD Service Object and Method Relations

Method	Status of support	Notes
Open	○	-
Close	○	-
ClaimDevice	○	-
ReleaseDevice	○	-
Enable	○	-
Disable	○	-
DisplayText	○	-
DisplayTextAt	○	-
ClearText	○	-

3-2-2-2. OPOS Driver

The **MB4000_OposSetup.exe** program sets up the registry information and example program of VFD for OPOS program uses.

1. Installation

Below steps guide you to install the **MB4000_OposSetup** program.

- Run the **MB4000_OposSetup** setup file
- This setup also installs the **Prox-PMP4000** program.
- Follow the wizard instructions to complete the installation.

2. Launching Program

Below steps guide you to load the **Prox-PMP4000** program.

- Click *LineDisplay* folder from the path *Start/Programs/Protech OPOS*.
- Click **Prox-PMP4000** to launch the program.

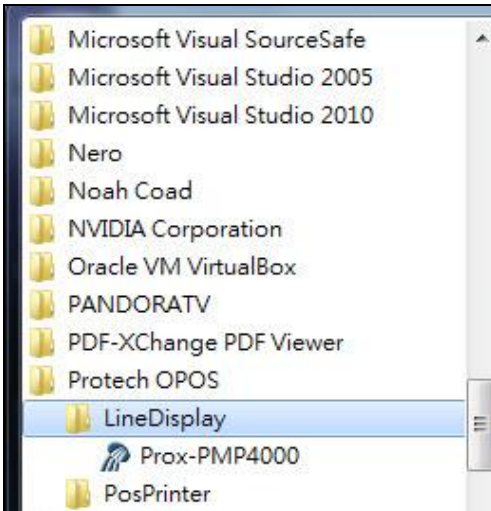

3. OPOS Control Object of **Prox-PMP4000** program

Main screen buttons:

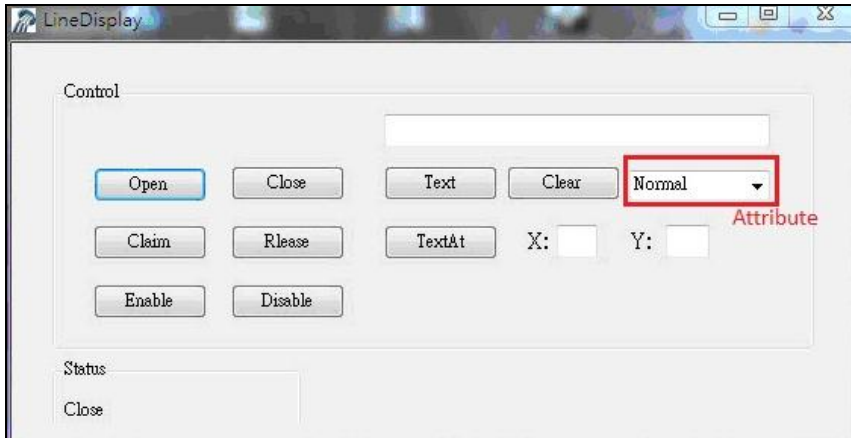

Button/Item	Description
Text	Display text at the current cursor position.
TextAt	Display the string of characters at the specified “y” and “x”.
Clear	Clear the message shown in the display screen.
Attribute	<ul style="list-style-type: none"> • Normal: Display the normal characters on the display screen. • Blink: Enable the display screen to blink. • Reverse: Enable the character printing in reverse black and white. • Blink+Reverse: Enable the display screen to blink and activate the character printing in reverse black and white.

4. MB4103 type

Key Name	Type	Default Value	Note
BaudRate	String	9600	UART Baud Rate (default)
BitLength	String	8	UART Data Bit (default)
Parity	String	0	UART Parity Bit (default)
Port	String	COM1	UART Port (default)
Stop	String	1	UART Stop Bit (default)

5. OPOS APIs Support List

	Category Type	Name	Mutability	OPOS APG Version	VFD .SO
Properties	common bool	AutoDisable	R/W	1.2	Not Applicable
Properties	common long	BinaryConversion	R/W	1.2	Not Applicable
Properties	common long	CapPowerReporting	Read only	1.3	Not Applicable
Properties	common string	CheckHealthText	Read only	1.0	Supported
Properties	common bool	Claimed	Read only	1.0	Supported
Properties	common long	DataCount	Read only	1.2	Not Applicable
Properties	common bool	DataEventEnabled	Read only	1.0	Not Applicable
Properties	common bool	DeviceEnabled	R/W	1.0	Not Applicable
Properties	common bool	FreezeEvents	R/W	1.0	Not Applicable
Properties	common long	OpenResult	Read only	1.5	Not Applicable
Properties	common bool	OutputID	Read only	1.0	Not Applicable
Properties	common bool	PowerNotify	R/W	1.3	Not Applicable
Properties	common bool	PowerState	Read only	1.3	Not Applicable
Properties	common long	ResultCode	Read only	1.0	Supported
Properties	common long	ResultCodeExtended	Read only	1.0	Not Applicable
Properties	common long	State	Read only	1.0	Supported
Properties	common string	ControlObject Description	Read only	1.0	Not Applicable
Properties	common long	ControlObject Version	Read only	1.0	Not Applicable
Properties	common string	ServiceObject Description	Read only	1.0	Supported
Properties	common long	ServiceObject Version	Read only	1.0	Supported
Properties	common string	DeviceDescription	Read only	1.0	Supported
Properties	common string	ControlObject Description	Read only	1.0	Not Applicable
Properties	specific long	CapBlink	Read only	1.0	Not Applicable
Properties	specific bool	CapBlinkRate	Read only	1.6	Not Applicable
Properties	specific bool	CapBrightness	Read only	1.0	Not Applicable
Properties	specific long	CapCharacterSet	Read only	1.0	Not Applicable
Properties	specific long	CapCursorType	Read only	1.6	Not Applicable
Properties	specific bool	CapCustomGlyph	Read only	1.6	Not Applicable
Properties	specific bool	CapDescriptors	Read only	1.0	Not Applicable
Properties	specific bool	CapHMarquee	Read only	1.0	Not Applicable

	Category Type	Name	Mutability	OPOS APG Version	VFD .SO
Properties	specific bool	CapICharWait	Read only	1.0	Not Applicable
Properties	specific long	CapReadBack	Read only	1.6	Not Applicable
Properties	specific long	CapReverse	Read only	1.6	Not Applicable
Properties	specific bool	CapVMarquee	Read only	1.0	Not Applicable
Properties	specific long	BlinkRate	R/W	1.6	Not Applicable
Properties	specific long	DeviceWindows	Read only	1.0	Not Applicable
Properties	specific long	DeviceRows	Read only	1.0	Not Applicable
Properties	specific long	DeviceColumns	Read only	1.0	Not Applicable
Properties	specific long	DeviceDescriptors	Read only	1.0	Not Applicable
Properties	specific long	DeviceBrightness	R/W	1.0	Not Applicable
Properties	specific long	CharacterSet	R/W	1.0	Not Applicable
Properties	specific string	CharacterSetList	Read only	1.0	Not Applicable
Properties	specific long	CurrentWindow	R/W	1.0	Not Applicable
Properties	specific long	Rows	Read only	1.0	Not Applicable
Properties	specific long	Columns	Read only	1.0	Not Applicable
Properties	specific long	CursorRow	R/W	1.0	Not Applicable
Properties	specific long	CursorColumn	R/W	1.0	Not Applicable
Properties	specific long	CursorType	R/W	1.6	Not Applicable
Properties	specific bool	CursorUpdate	R/W	1.0	Not Applicable
Properties	specific long	MarqueeType	R/W	1.0	Not Applicable
Properties	specific long	MarqueeFormat	R/W	1.0	Not Applicable
Properties	specific long	MarqueeUnitWait	R/W	1.0	Not Applicable
Properties	specific long	MarqueeRepeatWait	R/W	1.0	Not Applicable
Properties	specific long	InterCharacterWait	R/W	1.0	Not Applicable
Properties	specific string	CustomGlyphList	Read only	1.6	Not Applicable
Properties	specific long	GlyphHeight	Read only	1.6	Not Applicable
Properties	specific long	GlyphWidth	Read only	1.6	Not Applicable
Methods	common	Open	-	1.0	Supported
Methods	common	Close	-	1.0	Supported
Methods	common	Claim	-	1.0	Supported
Methods	common	ClaimDevice	-	1.0	Supported
Methods	common	Release	-	1.0	Supported
Methods	common	ReleaseDevice	-	1.0	Supported
Methods	common	CheckHealth	-	1.0	Not Applicable
Methods	common	ClearInput	-	1.0	Not Applicable
Methods	common	ClearOutput	-	1.0	Not Applicable

	Category Type	Name	Mutability	OPOS APG Version	VFD .SO
Methods	common	DirectIO	-	1.0	Not Applicable
Methods	specific	DisplayText	-	1.0	Supported
Methods	specific	DisplayTextAt	-	1.0	Supported
Methods	specific	ClearText	-	1.0	Supported
Methods	specific	ScrollText	-	1.0	Not Applicable
Methods	specific	SetDescriptor	-	1.0	Not Applicable
Methods	specific	ClearDescriptors	-	1.0	Not Applicable
Methods	specific	CreateWindow	-	1.0	Not Applicable
Methods	specific	DestroyWindow	-	1.0	Not Applicable
Methods	specific	RefreshWindow	-	1.0	Not Applicable)
Methods	specific	ReadCharacterAtCursor	-	1.6	Not Applicable
Methods	specific	DefineGlyph	-	1.6	Not Applicable
Events	common	DataEvent	-	1.0	Not Applicable
Events	common	DirectIOEvent	-	1.0	Not Applicable
Events	common	ErrorEvent	-	1.0	Not Applicable
Events	common	OutputComplete Event	-	1.0	Not Applicable
Events	common	StatusUpdate Event	-	1.3	Not Applicable

3-2-3. MSR: MB-3012 (PS/2)

3-2-3-1. OPOS Driver

The **MB301X_OposSetup.exe** program sets up the registry information of MSR reader for OPOS program uses.

1. Installation

Below steps guide you to install the **MB301X_OposSetup** program.

- Run the **OPOSMSR_Setup.exe** setup file.
- This setup also installs the Prox-PMP3000 program.
- Follow the wizard instructions to complete the installation.

2. Launching Program

Below steps guide you load the Prox-PMP3000 program.

- Click **MSR** folder from the path *Start/Programs/Protech OPOS*.
- Click **Prox-PMP3000** to launch the program.

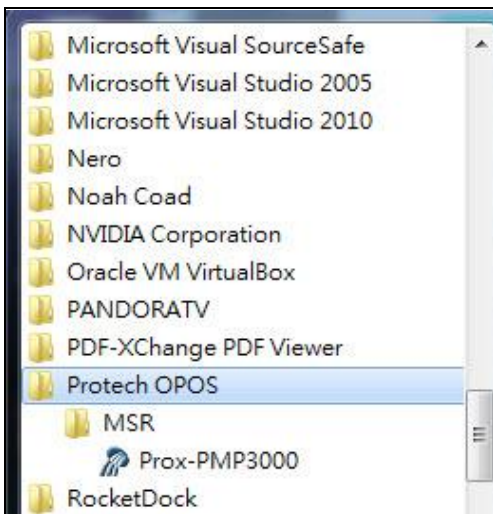

3. Configuration of **Prox-PMP3000** program

a.) Main screen & Control tab items:

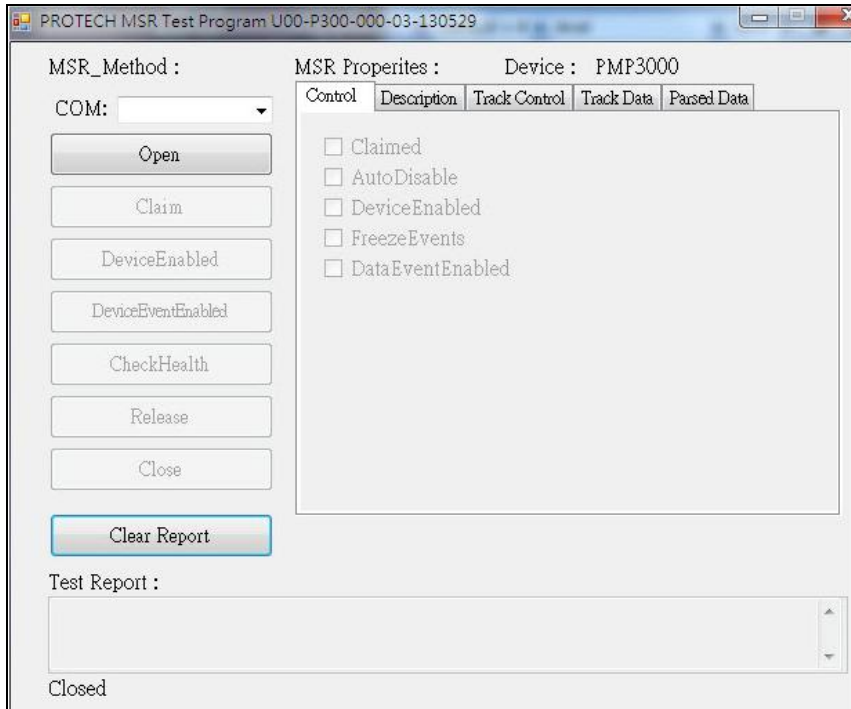

Button/Item	Description
COM	(drop-down list) To set COM port number (only for UART/USB interface).
AutoDisable	(check box) Set auto-disable
FreezeEvents	(check box) Set freeze events

b.) Description tab: S.O and C.O information

Control	Description	Track Control	Track Data	Parsed Data
DeviceControlDescription :				
OPOS MSR Control 1.6.000 [Public, by CRM/RCS-Dayton]				
DeviceControlVersion :				
1006000				
DeviceServiceDescription :				
PROTECH OPOS MSR Service Object				
DeviceServiceVersion :				
1007550				
PhysicalDeviceDescription :				
PROTECH OPOS MSR				
PhysicalDeviceName :				
OPOS.PMP3000MSR.SO				

c.) Track Control tab items

Control	Description	Track Control	Track Data	Parsed Data
<input checked="" type="checkbox"/>	DecodeData	ErrorReportingType :		
<input checked="" type="checkbox"/>	ParseDecodeData	CARD		
<input type="checkbox"/>	TransmitSentinels	TracksToRead :		
		Tracks123		

Button/Item	Description
DecodeData	Set decode data properties applicable).
ParseDecodeData	Set parse decode data properties
TransmitSentinels	Set transmit-sentinels properties
ErrorReporting Type	Card, track
TracksToRead	Track1, track2, track3, tracks12, tracks13, tracks14, tracks23, tracks24, tracks34, tracks123, tracks124, tracks134, tracks234, tracks1234 (Tracks4 is not applicable).

d.) Track Data tab items

Button/Item	Description
TracksData	(Row) Display data of all tracks (Track4 is not applicable).

e.) Parsed Data tab items

Button/Item	Description
Parsed Data	Display special properties.

4. MB301X type (RS232/PS2)

Key Name	Type	Default Value	Note
default	string	PMP3000	OPOS S.O Link

5. OPOS APIs support List

	Category Type	Name	Mutability	OPOS APG Version	VFD .SO
Properties	common bool	AutoDisable	R/W	1.2	Supported
Properties	common long	BinaryConversion	R/W	1.2	Not Applicable
Properties	common long	CapPowerReporting	Read only	1.3	Supported
Properties	common string	CheckHealthText	Read only	1.0	Supported
Properties	common bool	Claimed	Read only	1.0	Supported
Properties	common long	DataCount	Read only	1.2	Supported
Properties	common bool	DataEventEnabled	R/W	1.0	Supported
Properties	common bool	DeviceEnabled	R/W	1.0	Supported
Properties	common bool	FreezeEvents	R/W	1.0	Supported
Properties	common long	OpenResult	Read only	1.5	Supported
Properties	common long	OutputID	Read only	1.0	Not Applicable
Properties	common long	PowerNotify	R/W	1.3	Not Applicable
Properties	common long	PowerState	Read only	1.3	Not Applicable
Properties	common long	ResultCode	Read only	1.0	Supported
Properties	common long	ResultCodeExtended	Read only	1.0	Supported
Properties	common long	State	Read only	1.0	Not Applicable
Properties	common string	ControlObject Description	Read only	1.0	Not Applicable
Properties	common long	ControlObjectVersion	Read only	1.0	Not Applicable
Properties	common string	ServiceObject Description	Read only	1.0	Supported
Properties	common long	ServiceObjectVersion	Read only	1.0	Not Applicable
Properties	common string	DeviceDescription	Read only	1.0	Supported
Properties	common string	DeviceName	Read only	1.0	Supported
Properties	specific bool	CapISO	Read only	1.0	Supported
Properties	specific bool	CapJISOne	Read only	1.0	Supported
Properties	specific bool	CapJISTwo	Read only	1.0	Supported
Properties	specific bool	CapTransmitSentinels	Read only	1.5	Supported

	Category Type	Name	Mutability	OPOS APG Version	VFD .SO
Properties	specific long	TracksToRead	R/W	1.0	Supported
Properties	specific bool	DecodeData	R/W	1.0	Not Applicable
Properties	specific bool	ParseDecodeData	R/W	1.0	Supported
Properties	specific long	ErrorReportType	R/W	1.2	Not Applicable
Properties	specific string	Track1Data	Read only	1.0	Supported
Properties	specific string	Track2Data	Read only	1.0	Supported
Properties	specific string	Track3Data	Read only	1.0	Supported
Properties	specific string	Track4Data	Read only	1.5	Not Applicable
Properties	specific string	AccountNumber	Read only	1.0	Supported
Properties	specific string	ExpirationDate	Read only	1.0	Supported
Properties	specific string	Title	Read only	1.0	Supported
Properties	specific string	FirstName	Read only	1.0	Supported
Properties	specific string	MiddleInitial	Read only	1.0	Supported
Properties	specific string	Surname	Read only	1.0	Supported
Properties	specific string	Suffix	Read only	1.0	Supported
Properties	specific string	ServiceCode	Read only	1.0	Supported
Properties	specific binary	Track1 DiscretionaryData	Read only	1.0	Supported
Properties	specific binary	Track2 DiscretionaryData	Read only	1.0	Supported
Properties	specific bool	TransmitSentinels	R/W	1.5	Supported
Methods	common	Open	-	1.0	Supported
Methods	common	Close	-	1.0	Supported
Methods	common	Claim	-	1.0	Supported
Methods	common	ClaimDevice	-	1.5	Supported
Methods	common	Release	-	1.0	Supported
Methods	common	ReleaseDevice	-	1.5	Supported
Methods	common	CheckHealth	-	1.0	Not Applicable
Methods	common	ClearInput	-	1.0	Supported
Methods	common	ClearOutput	-	1.0	Not Applicable
Methods	common	DirectIO	-	1.0	Not Applicable
Events	common	DataEvent	-	1.0	Supported
Events	common	DirectIOEvent	-	1.0	Not Applicable
Events	common	ErrorEvent	-	1.0	Not Applicable
Events	common	OutputCompleteEvent	-	1.0	Not Applicable
Events	common	StatusUpdateEvent	-	1.0	Not Applicable

3-2-4. MSR: GIGA-TMS MJR243R (RS-232)

3-2-4-1. Command List

1. MSR Registry Operation

Registry Path: [HKEY_LOCAL_MACHINE\SOFTWARE\OLEforRetail\ServiceOPOS\MSR\MJR243]

Registry Name	Default Data	Notes
CapISO	1	Capability for reading ISO track data
CapJISOne	1	(reserved)
CapJISTwo	1	(reserved)
CapTransmitSentinels	1	Capability for reading Transmit Sentinels
Debug	0	Enable the tracing, and create a log file
Description	GIGATMS MSR POS	Description for SO driver
DeviceName	MJR243	Device Name for CO open
FileName	(NULL)	(reserved)
HardwareProvider	0	(reserved)
Model	MJR243	Device model name
Parity	None	Parity for the communication port
Port	COM4	Comport
Protocol	Hardware	Communication Control
Baudrate	19200	RS232 baudrate

2. OPOS MSR Service Object and Method Relations

Method	Status of support by the driver	Notes
Open	○	-
Close	○	-
Claim	○	-
ClaimDevice	○	-
Release	○	-
ReleaseDevice	○	-
ClearInput	○	-
ClearInputProperties	○	-
DataEvent	○	-
Claimed	○	Read only
DataCount	○	Read only
DataEventEnabled	○	R/W
DeviceEnabled	○	R/W
FreezeEvents	○	R/W
OpenResult	○	Read only
ResultCode	○	Read only
ResultCodeExtended	○	Read only
State	○	Read only
ControlObjectDescription	○	Read only
ControlObjectVersion	○	Read only
ServiceObjectDescription	○	Read only
ServiceObjectVersion	○	Read only
DeviceDescription	○	Read only
DeviceName	○	Read only
CapISO	○	Read only
CapTransmitSentinels	○	Read only
AccountNumber	○	Read only
DecodeData	○	R/W
ExpirationDate	○	Read only
FirstName	○	Read only
MiddleInitial	○	Read Only
ParseDecodeData	○	R/W

Method	Status of support by the driver	Notes
ServiceCode	○	Read Only
Suffix	○	Read Only
Surname	○	Read Only
Title	○	Read Only
Track1Data	○	Read Only
Track1DiscretionaryData	○	Read Only
Track2Data	○	Read Only
Track2DiscretionaryData	○	Read Only
Track3Data	○	Read Only
TracksToRead	○	R/W
TransmitSentinels	○	R/W

3-2-4-2. OPOS MSR Register

The **OPOS MSR Register** program sets up the registry information of MSRHK reader for OPOS program uses.

1. Installation

Below steps guide you to install the **OPOS MSR Register** program.

- Insert the setup CD
- Run the setup file **OPOSMSR_Setup.exe** located in the Software folder of CD.
- This setup also installs the **OPOS MSR Tester** program.
- Follow the wizard instructions to complete the installation.

2. Launching Program

Below steps guide you to load the **OPOS MSR Register** program.

- Click *OPOS* folder from the path *Start/Programs/GIGA-TMS*.
- Click **OPOS MSR Register** to launch the program.

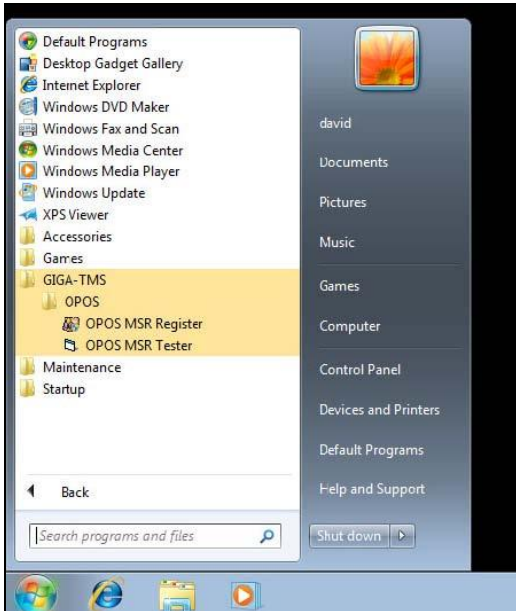

3. Configuration of **OPOS MSR Register** program

a.) Main screen buttons/items:

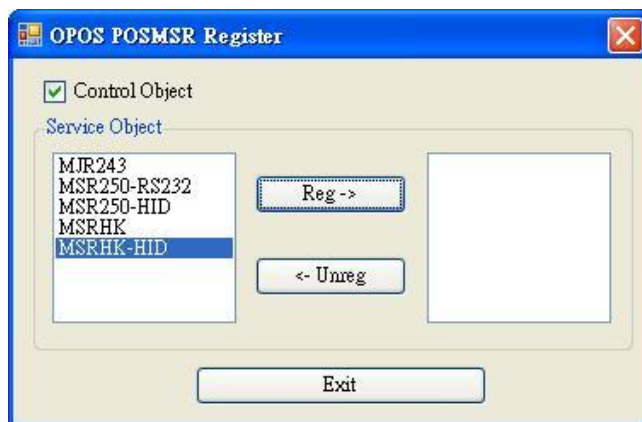

Button/Item	Description
Control Object	(Check box) Register the OPOSMSR.ocx common control object driver. This needs to be checked to run the OPOS MSR Tester program.
Service Object	(Left pane) The Service Object driver types. So far only four types are supported. Each type support specific MSR readers. For more details, please refer to the section <i>OPOS MSR Service Object and Method Relations</i> .
Service Object	(Right pane) The registered MSR with specified device name.
Reg→	Create a new device name for selected MSR.
← Unreg	Remove selected device name from registry.
Exit	End the program.

b.) Follow the steps below to register the MSRHK OPOS information.

Step 1: Select an item in **Service Object** List box (left pane). Make sure the correct item is selected.

Step 2: Click **Reg→** button

Step 3: In the **OPOS MSR Setting** screen, enter the device name and click **OK**.

c.) Example 1. MAGTEK USB HID



d.) Example 2. PROMAG MSR/MJR PART- NO, Keyboard mode.



e.) Example 3. PROGRAM MSR PART- NO, HID mode.

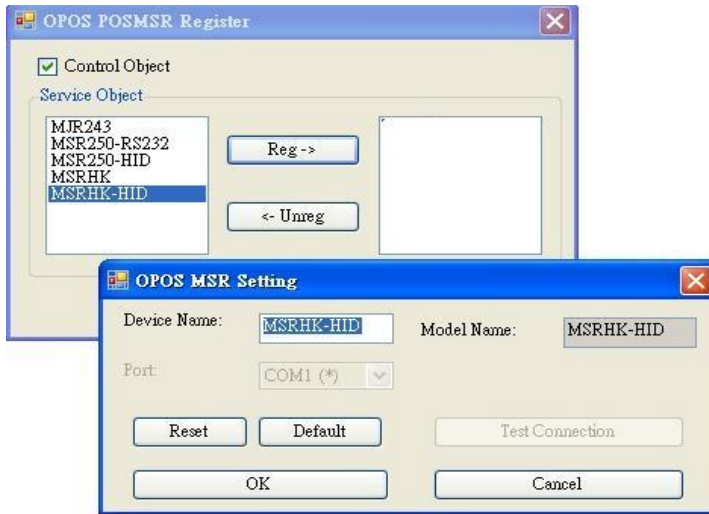

If your system doesn't have any other common control driver, then click Control Object check box.

Note: To run the **OPOPS MSR Tester** program, the Control Object must be checked.

4. MJR243 type

Key Name	Type	Default Value	Note
CapISO	string	1	Capability for reading ISO track data
CapJISOne	string	1	(reserved)
CapJISTwo	string	1	(reserved)
CapTransmitSentinels	string	1	Capability for reading Transmit Sentinels
Debug	string	0	Enable the tracing, and create a log file
Description	string	GIGATMS MSR POS	Description for SO driver
DeviceName	string	MJR243	Device Name for CO open
FileName	string	(NULL)	(reserved)

Key Name	Type	Default Value	Note
HardwareProvider	string	0	(reserved)
Model	string	MJR243	Device model name
Parity	string	None	Parity for the communication port
Port	string	COM4	Comport Number
Protocol	string	Hardware	Communication Control
Baudrate	string	19200	RS232 baudrate

5. OPOS APIs support list

	Category Type	Name	Mutability	OPOS APG Version	MSR .SO
Properties	common bool	AutoDisable	R/W	1.2	Not Applicable
Properties	common long	BinaryConversion	R/W	1.2	Not Applicable
Properties	common bool	CapCompare FirmwareVersion	Read only	1.9	Not Applicable
Properties	common long	CapPowerReporting	Read only	1.3	Not Applicable
Properties	common bool	CapStatisticsReporting	Read only	1.8	Not Applicable
Properties	common bool	CapUpdateFirmware	Read only	1.9	Not Applicable
Properties	common bool	CapUpdateStatistics	Read only	1.8	Not Applicable
Properties	common string	CheckHealthText	Read only	1.0	Not Applicable
Properties	common bool	Claimed	Read only	1.0	Supported
Properties	common long	DataCount	Read only	1.2	Supported
Properties	common bool	DataEventEnabled	R/W	1.0	Supported
Properties	common bool	DeviceEnabled	R/W	1.0	Supported
Properties	common bool	FreezeEvents	R/W	1.0	Supported
Properties	common long	OpenResult	Read only	1.5	Supported
Properties	common long	OutputID	Read only	1.0	Not Applicable
Properties	common long	PowerNotify	R/W	1.3	Not Applicable
Properties	common long	PowerState	Read only	1.3	Not Applicable
Properties	common long	ResultCode	Read only	1.0	Supported
Properties	common long	ResultCodeExtended	Read only	1.0	Supported
Properties	common long	State	Read only	1.0	Supported
Properties	common string	ControlObject Description	Read only	1.0	Supported
Properties	common long	ControlObjectVersion	Read only	1.0	Supported
Properties	common	ServiceObject	Read only	1.0	Supported

	Category Type	Name	Mutability	OPOS APG Version	MSR .SO
	string	Description			
Properties	common long	ServiceObjectVersion	Read only	1.0	Supported
Properties	common string	DeviceDescription	Read only	1.0	Supported
Properties	common string	DeviceName	Read only	1.0	Supported
Properties	specific bool	CapISO	Read only	1.0	Supported
Properties	specific bool	CapJISOne	Read only	1.0	Not Applicable
Properties	specific bool	CapJISTwo	Read only	1.0	Not Applicable
Properties	specific bool	CapTransmit Sentinels	Read only	1.5	Supported
Properties	specific long	CapWriteTracks	Read only	1.1	Not Applicable
Properties	specific string	AccountNumber	Read only	1.0	Supported
Properties	specific bool	DecodeData	R/W	1.0	Supported
Properties	specific long	EncodingMaxLength	Read only	1.1	Not Applicable
Properties	specific long	ErrorReportType	R/W	1.2	Not Applicable
Properties	specific string	ExpirationDate	Read only	1.0	Supported
Properties	specific string	FirstName	Read only	1.0	Supported
Properties	specific string	MiddleInitial	Read only	1.0	Supported
Properties	specific bool	ParseDecodeData	R/W	1.0	Supported
Properties	specific string	ServiceCode	Read only	1.0	Supported
Properties	specific string	Suffix	Read only	1.0	Supported
Properties	specific string	Surname	Read only	1.0	Supported
Properties	specific string	Title	Read only	1.0	Supported
Properties	specific binary	Track1Data	Read only	1.0	Supported
Properties	specific binary	Track1 DiscretionaryData	Read only	1.0	Supported
Properties	specific binary	Track2Data	Read only	1.0	Supported
Properties	specific binary	Track2 DiscretionaryData	-	1.0	Supported
Properties	specific binary	Track3Data	Read only	1.0	Supported
Properties	specific binary	Track4Data	Read only	1.5	Not Applicable
Properties	specific long	TracksToRead	R/W	1	Supported

	Category Type	Name	Mutability	OPOS APG Version	MSR .SO
Properties	specific long	TracksToWrite	R/W	1.1	Not Applicable
Properties	specific bool	TransmitSentinels	R/W	1.5	Supported
Methods	common	Open	-	1	Supported
Methods	common	Close	-	1	Supported
Methods	common	Claim	-	1	Supported
Methods	common	ClaimDevice	-	1.5	Supported
Methods	common	Release	-	1	Supported
Methods	common	ReleaseDevice	-	1.5	Supported
Methods	common	CheckHealth	-	1	Not Applicable
Methods	common	ClearInput	-	1	Supported
Methods	common	ClearInput Properties	-	1.1	Supported
Methods	common	ClearOutput	-	1	Not Applicable
Methods	common	DirectIO	-	1	Not Applicable
Methods	common	Compare FirmwareVersion	-	1.9	Not Applicable
Methods	common	ResetStatistics	-	1.8	Not Applicable
Methods	common	RetrieveStatistics	-	1.8	Not Applicable
Methods	common	UpdateFirmware	-	1.9	Not Applicable
Methods	common	UpdateStatistics	-	1.8	Not Applicable
Events	common	DataEvent	-	1.0	Supported
Events	common	DirectIOEvent	-	1.0	Not Applicable
Events	common	ErrorEvent	-	1.0	Not Applicable
Events	common	OutputCompleteEvent	-	1.0	Not Applicable
Events	common	StatusUpdateEvent	-	1.0	Not Applicable

3-2-4-3. OPOS MSR Tester

The **OPOS MSR Tester** program is used to get the track data of MSRHK reader via the OPOS driver. Before running the program, make sure the device name registry information for MSRHK reader has been already created by OPOS MSR Register program.

1. Installation

The installation of **OPOS MSR Tester** program goes together with OPOS MSR Register program.

2. Launching Program

Below steps guide you to load the **OPOS MSR Tester** program.

- Click *OPOS* folder from the path *Start\Programs\GIGA-TMS*.
- Click **OPOS MSR Tester** to launch the program.

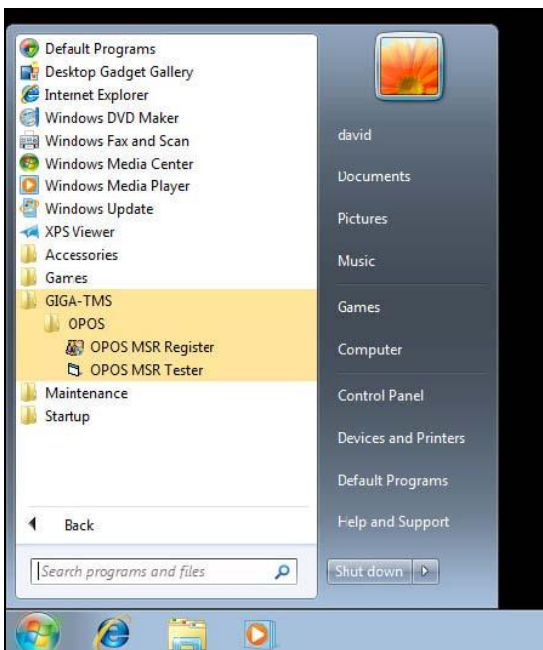

3. Configuration for OPOS MSR Tester Program

a.) Main screen buttons/items:

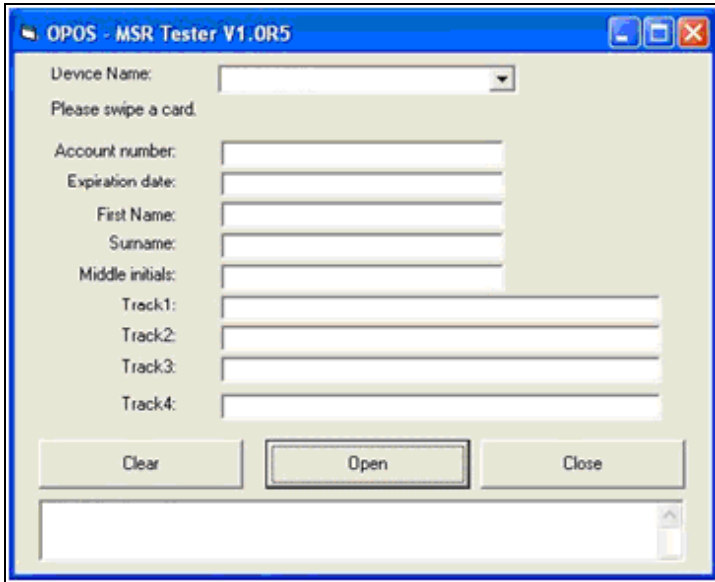

Button/Item	Description
Device Name	(Combo box) Enter the device name that to be loaded to the program.
Track Data	(Text boxes) Show the raw and parsed track data.
Clear	(Button) Clear all the track data in the text boxes.
Open	(Button) Open the OPOS driver and ready to get track data.
Close	(Button) Close the OPOS driver.
Message	(Text box) Display the result message of running the OPOS driver.

b.) To start using OPOS driver to get track data, follow the steps below.

Step 1: Entering the **Device Name**.

Step 2: Clicking **Open** button.

Step 3: Swiping card to get track data.

c.) Example 1. MAGTEK USB HID.

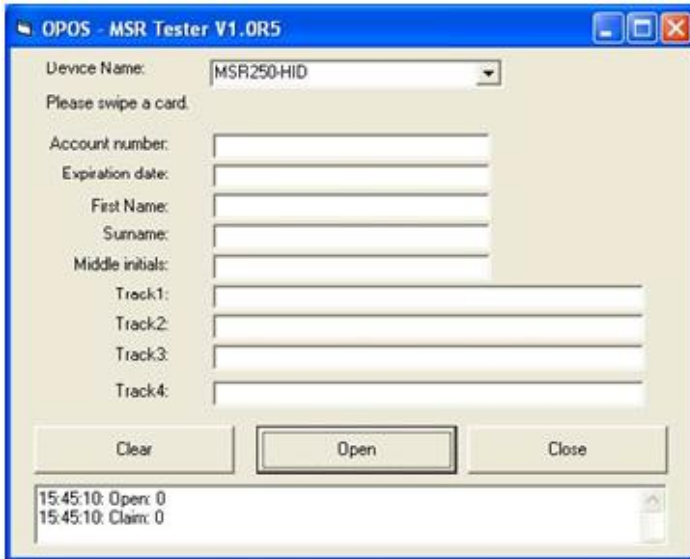

d.) Example 2. PROMAG MSR/MJR PART- NO, Keyboard mode

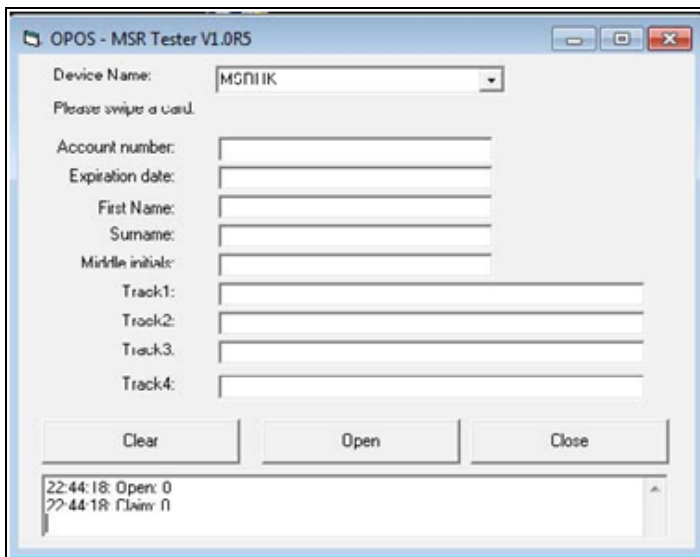

e.) Example 3. PROMAG MSR PART- NO, HID mode

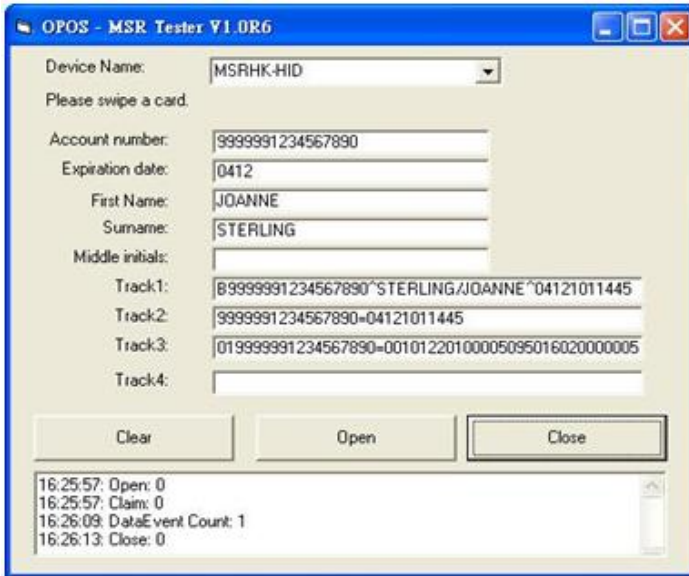

3-3. API

3-3-1. API Package Content

You can find API Package files in the enclosed Manual/Driver CD. Depending on machine types, the API Package may include the following files.

Function DLL			
Directory	Function	File Name	Description
ProxAPI standard\	Cash Drawer	Cash Drawer.dll	Driver to control Cash Drawer
	WDT	Watchdog.dll	Driver to control Watchdog
	Hardware Monitor	Hardware Monitor.dll	Driver to read hardware data
	multilangXML.dll		Driver to open XML file
	Initial.xml		XML file to initiate the API Package
	ProxAP.exe		API program executable file
	XML Files\Model Name*\Initial.xml		XML file for each model
	Version.ini		Version information

Sample Program		
Directory	Contents / File Name	Description
DEMO PROJECT\	DEMO PROJECT\GPIO Sample Code	C# VB6 VB.net Source Code
	DEMO PROJECT\Digital Sample Code	C# VB6 VB.net Source Code
	DEMO PROJECT\Watchdog Sample Code	C# VB6 VB.net MFC Source Code

3-3-2. API Procedure

Take **VB2005 .NET** for example.

1. First you must declare a function. You may create a module in your project and fill in the function.

Example: Cash drawer

```
Declare Function GetCashDrawerStatus Lib CashDrawer.dll (ByVal num_drawer as short) As Boolean
```

```
Declare Function CashDrawerOpen Lib CashDrawer.dll (ByVal num_drawer as short) As Boolean
```

2. Then create a button to call API Function.

- a.) Call Cash drawer open event:

```
Private Sub cash_btn1_Click (ByVal Sender As System.Object, ByVal e As System.EventArgs) Handles cash_btn1.Click  
CashDrawerOpen(1), "1" specifies the cash drawer 1 port  
CashDrawerOpen(2), "2" specifies the cash drawer 2 port  
Timer1.start
```

- b.) Detect Cash drawer status:

A timer event can be created.

```
Private Sub Timer1_Tick (ByVal Sender As System.Object,ByVal e As System.EventArgs) Handles Timer1.Tick  
Dim Receive_Status1 as Boolean  
Dim Receive_Status2 as Boolean  
Receive_Status1 = CashDrawerOpen(&H1)  
If Receive_Status1 = true then  
Text1.text = "cash drawer1 open" 'enter text into textbox.  
Else
```

```
Text1.text = "cash drawer1 close" 'enter text into textbox.
End if
=====
    Receive_Status2 = CashDrawerOpen(&H2)
    If Receive_Status2 = true then
        Text2.text = "cash drawer2 open" 'enter text into textbox.
    Else
        Text2.text = "cash drawer2 close" 'enter text into textbox.
    End if
=====
End sub
```

3-3-3. Sample Code

1. VB Declaration Method

Declare Function GetCashDrawerStatus Lib CashDrawer.dll (ByVal num_drawer as short) As Boolean

Declare Function CashDrawerOpen Lib CashDrawer.dll (ByVal num_drawer as short) As Boolean

- Call Function

Open cash drawer:

CashDrawerOpen(1)

Open cash drawer1

CashDrawerOpen(2)

Open cash drawer2

Check cash drawer status:

Dim receive_status as Boolean

Check cash drawer1 status

Receive_Status = CashDrawerOpen(&H1)

Check cash drawer2 status

Receive_Status = CashDrawerOpen(&H2)

2. C# Declaration Method

```
Public class PortAccess
{
[DllImport("CashDrawer.dll",EntryPoint = "Initial_CashDrawer")]
Public static extern void Initial_CashDrawer();
[DllImport("CashDrawer.dll",EntryPoint= "GetCashDrawerStatus")]
Public static extern bool GetCashDrawerStatus()
[DllImport("CashDrawer.dll",EntryPoint = "CashDrawerOpen")]
Public static extern bool CashDrawerOpen(short num_drawer);}
```

- Call Function

Open cash drawer1

```
PortAccess.CashDrawerOpen(0x01); //check cash drawer1 status
```

Open cash drawer2

```
PortAccess.CashDrawerOpen(0x02); //check cash drawer2 status
```

```
Bool bstatus;
```

```
bstatus = PortAccess.GetCashDrawerStatus(0x01);
```

```
bstatus = PortAccess.GetCashDrawerStatus(0x02); //Before get cash drawer status,  
need to initial cash drawer first
```

3. VB.NET extern function:

Declare Function SetMinSec Lib "WatchDog.dll" (ByVal kind As Short,ByVal delay_time As Short) As Boolean

Declare Function Stopwatchdog Lib "WatchDog.dll" () As Short

Declare Function Setwatchdog Lib "WatchDog.dll" (ByVal value As Short) As Boolean

Declare Function Digital_Initial Lib "Digital.dll" () As Long

Declare Function Digital_Set Lib "Digital.dll"(ByVal hex_value As Short) As Long

Declare Function Digital_Get Lib "Digital.dll" () As Short

Declare Function GPIO_Initial Lib "GPIO.dll" () As Long

Declare Function GPIO_SetPort Lib "GPIO.dll"(ByVal direct As long)

Declare Function GPIO_Set Lib "GPIO.dll"(ByVal dout_value As long) As Boolean

Declare Function GPIO_Get Lib "GPIO.dll"() As Short

Declare Function GetCashDrawerStatus Lib CashDrawer.dll (ByVal num_drawer as short) As Boolean

Declare Function CashDrawerOpen Lib CashDrawer.dll (ByVal num_drawer as short) As Boolean

4. VB 6 extern function:

Declare Function CashDrawerOpen Lib "CashDrawer.dll" (ByVal num_drawer As Integer) As Boolean

Declare Function GetCashDrawerStatus Lib "CashDrawer.dll" (ByVal num_drawer As Integer) As Boolean

Note: VB.net short = integer VB6

3-3-4. Cash Drawer

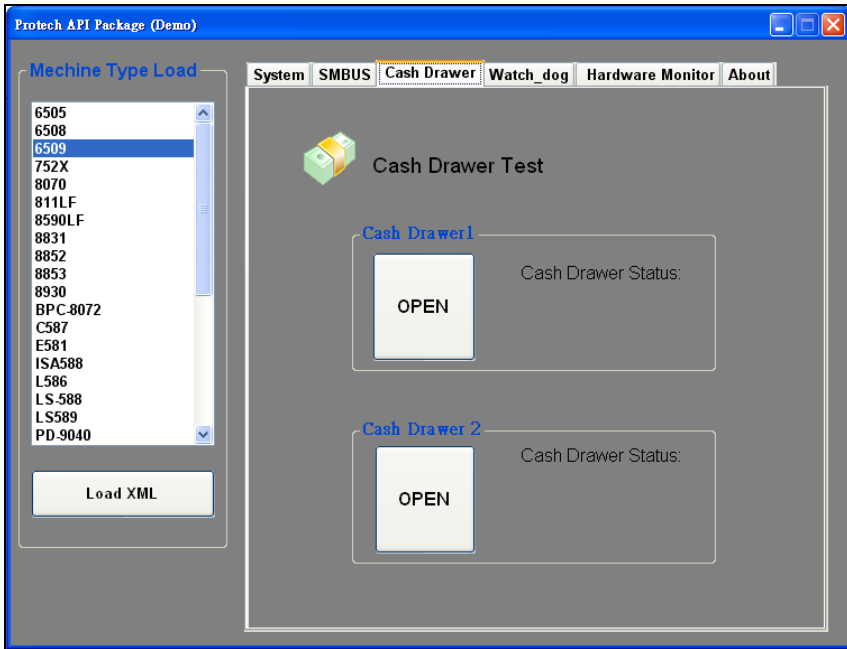

Button/Item	Description				
OPEN (button)	Tap to open the cash drawer.				
Cash Drawer Status	<p>Cash drawer status will be displayed after OPEN is tapped.</p> <ul style="list-style-type: none"> Drawer is closed as shown: <table border="1" data-bbox="793 1095 1006 1211"> <tr> <td>Cash Drawer Status:</td> </tr> <tr> <td>Close</td> </tr> </table> Drawer is open as shown: <table border="1" data-bbox="793 1229 1006 1333"> <tr> <td>Cash Drawer Status:</td> </tr> <tr> <td>Open</td> </tr> </table> 	Cash Drawer Status:	Close	Cash Drawer Status:	Open
Cash Drawer Status:					
Close					
Cash Drawer Status:					
Open					

3-3-5. Watch Dog



Button/Item	Description
Count Mode	Select the unit of time, second or minute, for the watchdog timer.
Setting Time	Set Timeout: Set the timeout for the watchdog. The maximum timeout value is 255 seconds or minutes.
Watchdog Control	<ul style="list-style-type: none"> ▪ Timeout Value: Simulation timer of the API program, the running watchdog timeout will be displayed (in seconds). It is not as accurate as a hardware watchdog clock. ▪ START: (button) Tap to start the watchdog timer. Meanwhile the REFRESH and STOP buttons will be enabled. ▪ REFRESH: (button) Tap to restart the watchdog timer. ▪ STOP: (button) Tap to stop the watchdog timer.

3-3-6. Hardware Monitor (Preview)

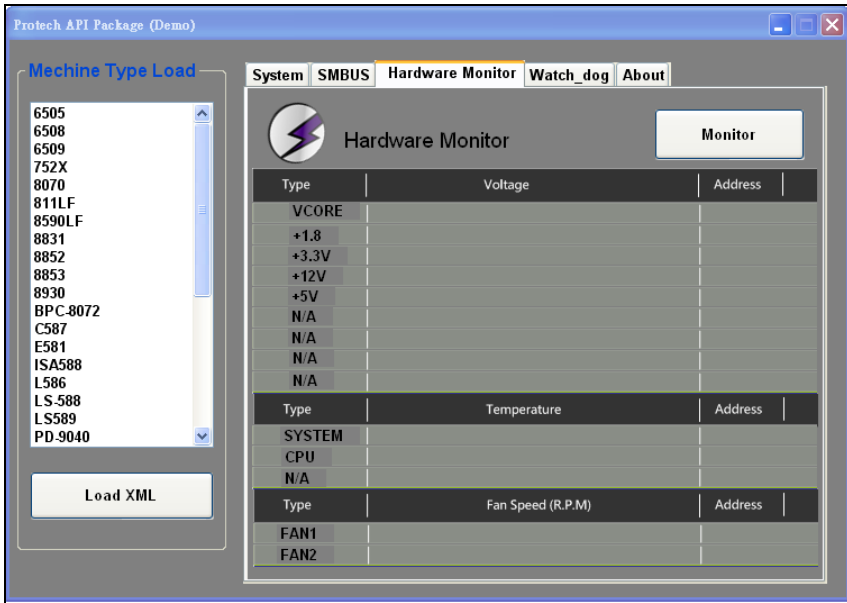

Button/Item	Description
Monitor (button)	Tap to get the hardware monitoring values, such as the voltages, temperatures, and fan speeds (rpm).

3-3-7. API Function

The API program-related sample programs, developed in VB.Net and C#, are provided for easy use of the API Package. Refer to the main API functions listed as below.

API Function		DLL	
Cash Drawer	CashDrawerOpen	multilangXML.dll	CashDrawer.dll
	GetCashDrawerStatus		
Watchdog (WD)	Watchdog_Set		
	Watchdog_Stop		
	Watchdog_SetMinSec		
Hardware Monitor	HMWVotlage_Get		Hardware Montior.dll
	HWMtTemperature_Get		
	HWMFanSpeed_Get		

3-3-8. Cash Drawer Function

CashDrawerOpen

bool CashDrawerOpen (short num_drawer);

Purpose: Open the cash drawer API.
Value: num_drawer = 1 (Open the Cash Drawer1)
num_drawer = 2 (Open the Cash Drawer2)
Return: True (1) on success, False (0) on failure

Example: CashDrawerOpen(0x01); // Open the Cash Drawer1

GetCashDrawerStatus

bool GetCashDrawerStatus (short num_drawer);

Purpose: Get the cash drawer status.
Value: num_drawer = 1 (Get the Cash Drawer1 status)
num_drawer = 2 (Get the Cash Drawer2 status)
Return: True (1) on success, False (0) on failure

Example: Short data;
data= GetCashDrawerStatus(0x01); // Get the Cash Drawer1 status
if (data)
MsgBox("open1"); // Cash Drawer1 status "Open"
Else
MsgBox("close1"); // Cash Drawer1 status "Close"
Endif

3-3-9. Watch Dog Function

Watchdog_Set

bool Watchdog_Set (int value)

Purpose: Set the timeout for the watchdog timer.
Value: value = 0 ~ 255
Return: True (1) on success, False (0) on failure

Watchdog_SetMinSec

bool Watchdog_SetMinSec (int kind)

Purpose: Set the unit of time as second/ minute.
Value: kind = 1 (Measured in unit of second)
kind = 2 (Measured in unit of minute)
Return: True (1) on success, False (0) on failure

Watchdog_Stop

bool Watchdog_Stop (void)

Purpose: Stop the watchdog timer.
Value: None
Return: True (1) on success, False (0) on failure

Watchdog_Recount

bool Watchdog_Recount (void)

Purpose: Restart the watchdog timer.
Value: None
Return: True (1) on success, False (0) on failure

3-3-10. Hardware Monitor Function**HMWVoltage_Get****float HMWVoltage_Get (short VoltType)**

Purpose: Get the hardware monitoring voltage value.

Value:

VoltType	81866
0x01	Vcore
0x02	5VSB
0x03	VCC5V
0x04	VCC12
0x05	N/A
0x06	N/A
0x07	N/A

Return: Float type data on voltage value

HMWTemperature_Get**float HMWTemperature_Get (short TempType)**

Purpose: Get the hardware monitoring temperature value.

Value:

TempType	81866
0x01	CPU temperature
0x02	System temperature
0x03	N/A

Return: Float type data on temperature value

3-4. BIOS Operation

3-4-1. Introduction

The board PA-3122 uses an AMI Aptio BIOS that is stored in the Serial Peripheral Interface Flash Memory (SPI Flash) and can be updated. The SPI Flash contains the BIOS Setup program, Power-on Self-Test (POST), the PCI auto-configuration utility, LAN EEPROM information, and Plug and Play support.

Aptio is AMI's BIOS firmware based on the UEFI (Unified Extensible Firmware Interface) Specifications and the Intel Platform Innovation Framework for EFI. The UEFI specification defines an interface between an operating system and platform firmware. The interface consists of data tables that contain platform-related information, boot service calls, and runtime service calls that are available to the operating system and its loader. These provide standard environment for booting an operating system and running pre-boot applications. Following illustration shows Extensible Firmware Interface's position in the software stack.

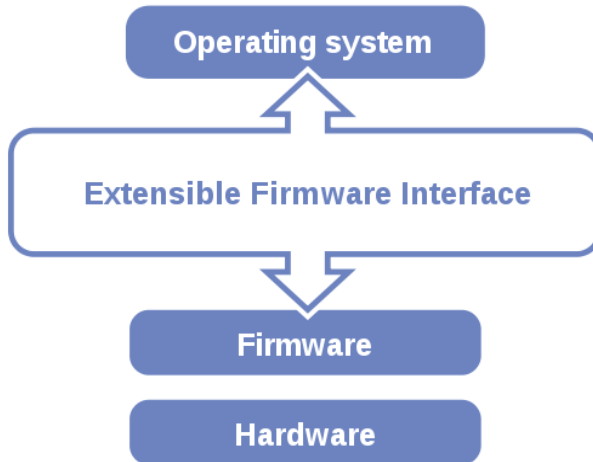

EFI BIOS provides an user interface allow users the ability to modify hardware configuration, e.g. change system date and time, enable or disable a system component, decide bootable device priorities, setup personal password, etc., which is convenient for modifications and customization of the computer system and allows technicians another method for finding solutions if hardware has any problems.

The BIOS Setup program can be used to view and change the BIOS settings for the computer. The BIOS Setup program is accessed by pressing the or <ESC> key after the POST memory test begins and before the operating system boot begins. The settings are shown below.

3-4-2. Entering Setup

When the system is powered on, the BIOS will enter the Power-On Self-Test (POST) routines and the following message will appear on the lower screen:

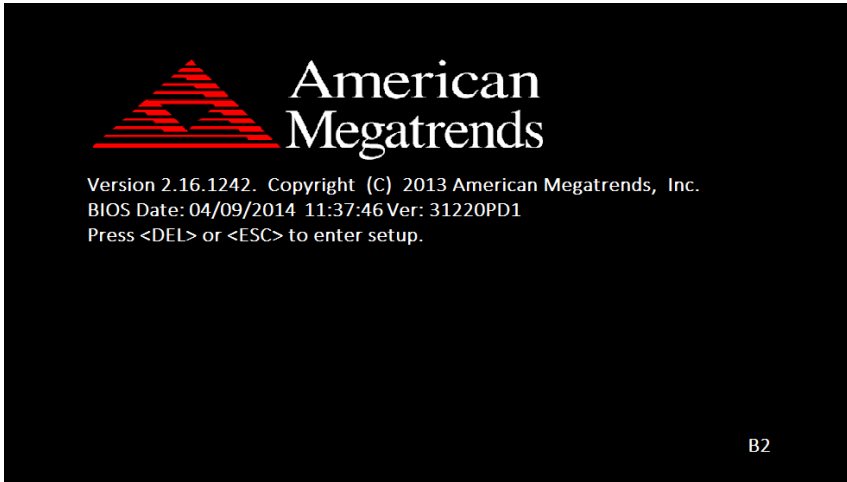

POST Screen

As long as this message is present on the screen you may press the key (the one that shares the decimal point at the bottom of the number keypad) to access the Setup program. In a moment, the main menu of the Aptio Setup Utility will appear on the screen:

**BIOS Setup Program Initial Screen**

You may move the cursor by up/down keys to highlight the individual menu items. As you highlight each item, a brief description of the highlighted selection will appear at the bottom of the screen.

3-4-3. Main

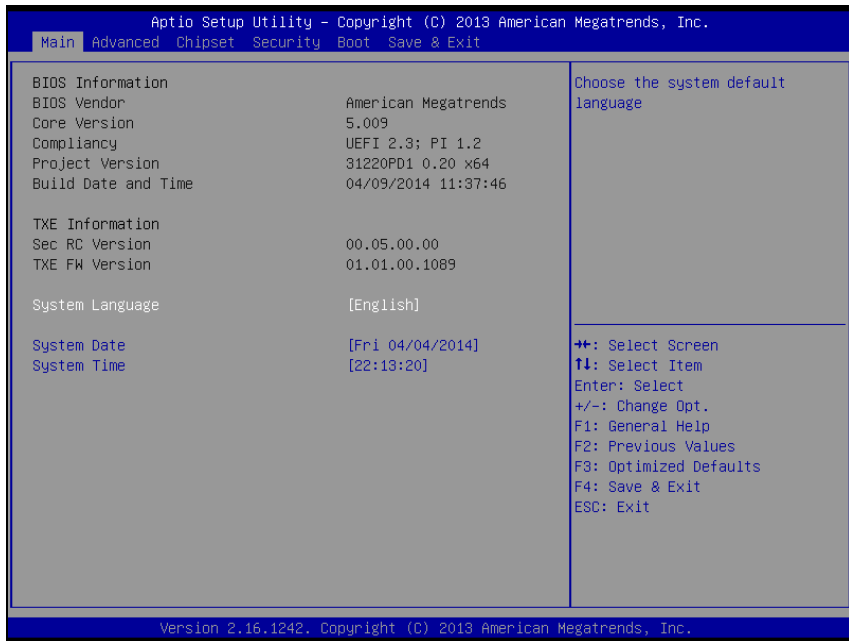

Main Screen

BIOS Setting	Options	Description/Purpose
BIOS Vendor	No changeable options	Displays the BIOS vendor.
Core Version	No changeable options	Displays the current BIOS core version.
Compliance	No changeable options	Displays the current UEFI version.
Project Version	No changeable options	Displays the version of the BIOS currently installed on the platform.
Build Date and Time	No changeable options	Displays the date of current BIOS version.
Sec RC Version	No changeable options	Displays the current Sec RC version.
TXE FW Version	No changeable options	Displays the current TXE Version

BIOS Setting	Options	Description/Purpose
System Language	English	BIOS Setup language.
System Date	Month, day, year	Specifies the current date.
System Time	Hour, minute, second	Specifies the current time.

3-4-4. Advanced

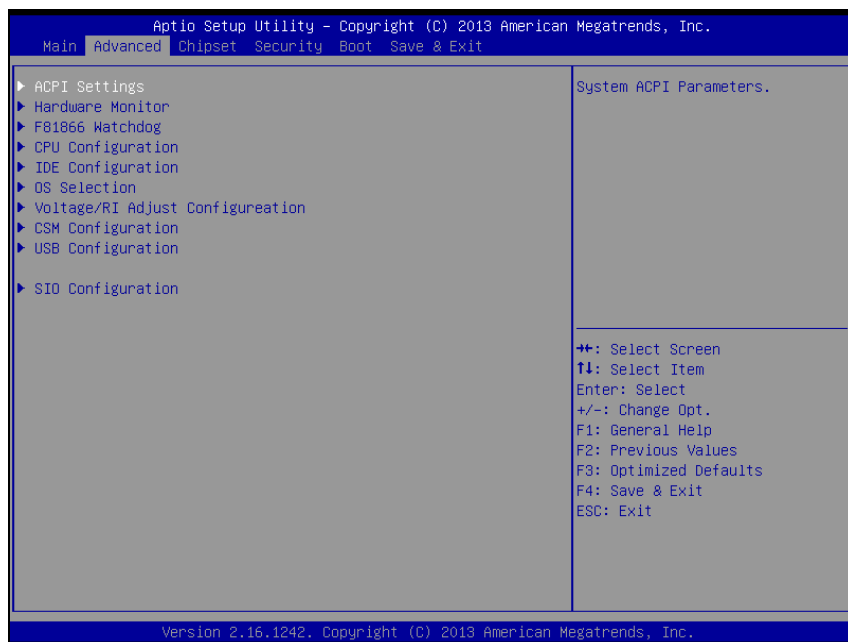

Advanced Screen

BIOS Setting	Options	Description/Purpose
ACPI Settings	Sub-Menu	System ACPI Parameters.
Hardware Monitor	Sub-Menu	Monitor hardware status
F81866 Watchdog	Sub-Menu	F81866 Watchdog Parameters.
CPU Configuration	Sub-Menu	CPU Configuration. Parameters.
IDE Configuration	Sub-Menu	SATA Configuration Parameters.
OS Selection	Sub-Menu	OS Selection
Voltage/RI Adjust Configuration	Sub-Menu	Voltage/RI Adjust settings.
CSM Configuration	Sub-Menu	Configure Option ROM execution, boot options filters, etc..
USB Configuration	Sub-Menu	USB Configuration Parameters.
SIO Configuration	Sub-Menu	System Super IO Chip Configuration.

3-4-4-1. ACPI Settings

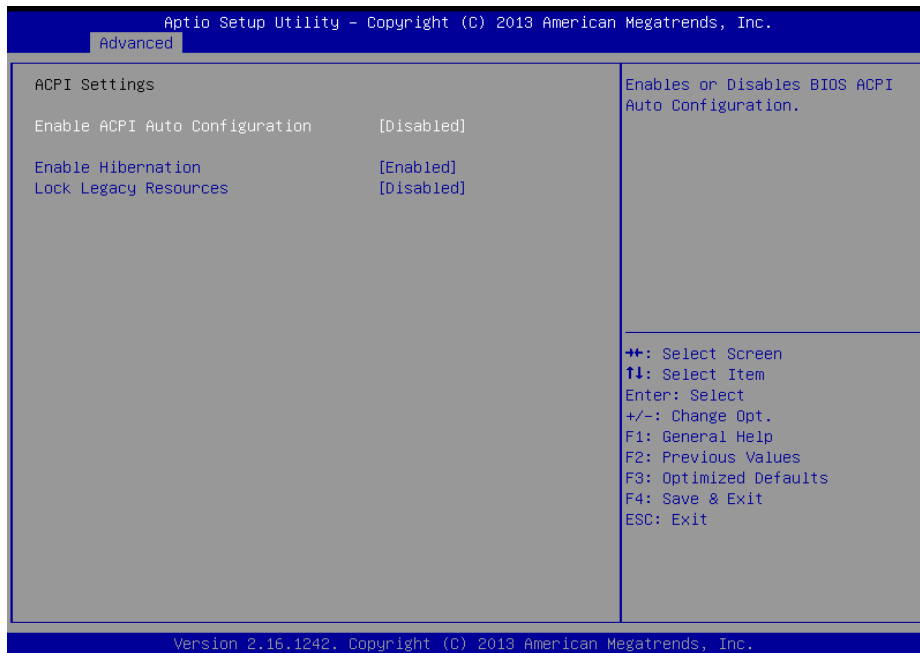

ACPI Settings Screen

BIOS Setting	Options	Description/Purpose
Enable ACPI Auto Configuration	- Disabled - Enabled	Enables or Disables ACPI feature.
Enable Hibernation	- Disabled - Enabled	Enables or Disables System ability to Hibernate (OS/S4 Sleep State). This option may be not effective with some OS.
Lock Legacy Resources.	- Disabled - Enabled	Enables or Disables Lock of Legacy Resources.

3-4-4-2. Hardware Monitor

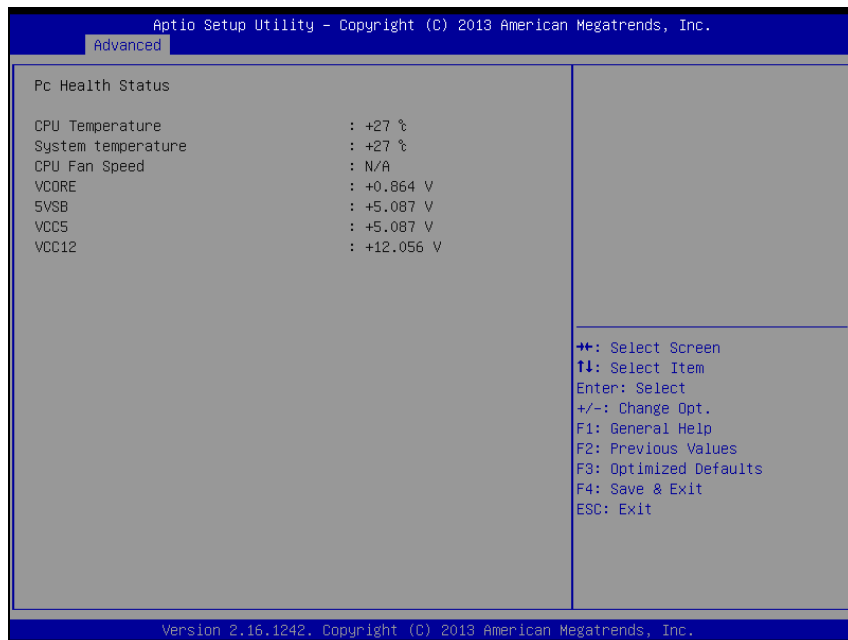

Hardware Monitor Screen

BIOS Setting	Options	Description/Purpose
CPU Temperature	No changeable options	Displays processor's temperature.
System Temperature	No changeable options	Displays system's temperature.
CPU Fan Speed	No changeable options	Displays fan's speed.
VCORE	No changeable options	Displays voltage level of the +VCORE in supply.
5VSB	No changeable options	Displays voltage level of the +VSB5 in supply.
VCC5	No changeable options	Displays voltage level of the + VCC5 in supply.
VCC12	No changeable options	Displays voltage level of the + VCC12 in supply.

3-4-4-3. F81866 Watchdog

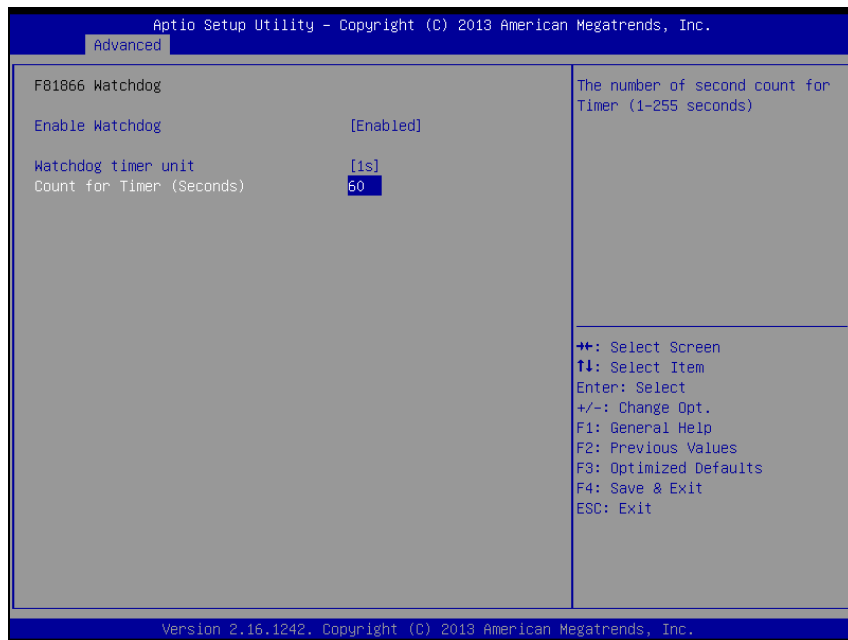

F81866 Watchdog Screen

BIOS Setting	Options	Description/Purpose
Enable WatchDog	-Enabled -Disable	Enable/Disable Watch dog timer.
Watchdog timer unit	-1s -60s	Select seconds or minutes
Count for Timer (Seconds)	Multiple options ranging from 1 to 255	Sets the desired value (seconds) for watchdog timer.

3-4-4-4. CPU Configuration

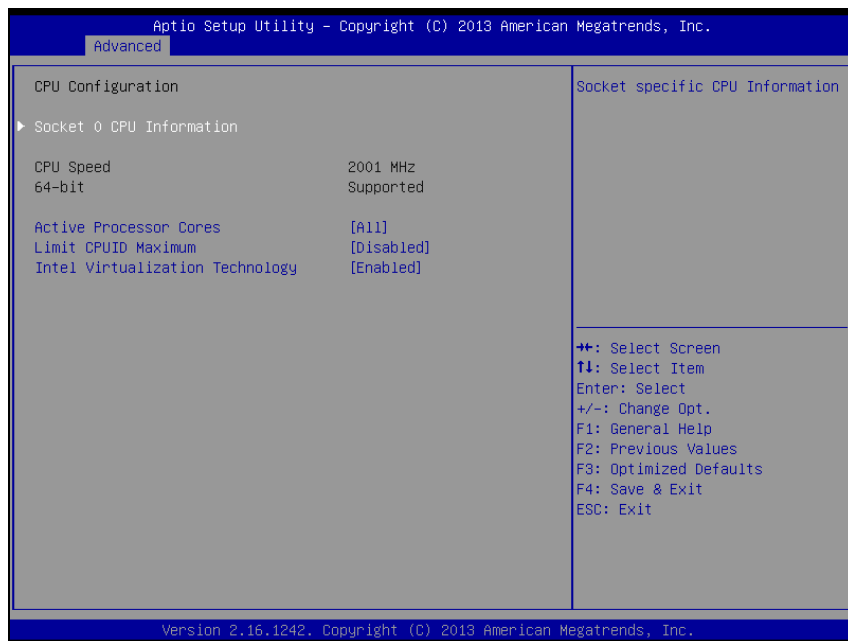

CPU Configuration Screen

BIOS Setting	Options	Description/Purpose
CPU Signature	No changeable options	Reports the CPU Signature
Socket 0 CPU Information	Sub-Menu	Report CPU Information
CPU Speed	No changeable options	Reports the current CPU Speed
64-bit	No changeable options	Reports if 64-bit is supported by processor.
Active Processor Cores	- All - 1	Choose the number of cores to be enabled in current processor.
Limit CPUID Maximum	- Disabled - Enabled	Enables for legacy operating systems to boot processors with extended CPUID functions. Set disable for Win XP.

BIOS Setting	Options	Description/Purpose
Intel Virtualization Technology	- Disabled - Enabled	When enabled, a VMM can utilize the additional hardware capabilities provided by Vanderpool Technology (VT).

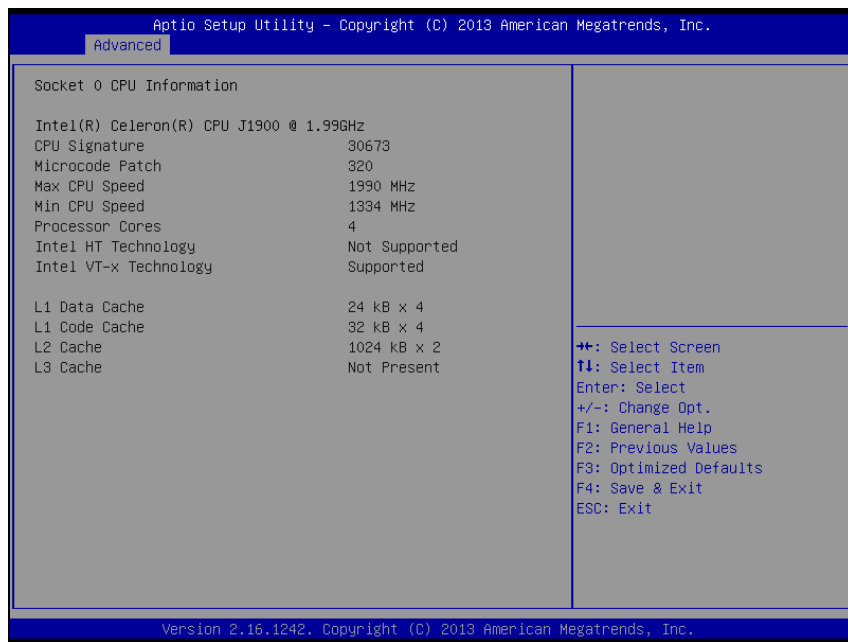

Socket 0 CPU Information Screen

BIOS Setting	Options	Description/Purpose
CPU Signature	No changeable options	Reports the CPU Signature
Microcode Patch	No changeable options	Reports the CPU Microcode Patch Version.
Max CPU Speed	No changeable options	Reports the maximum CPU Speed.
Min CPU Speed	No changeable options	Reports the minimum CPU Speed
Processor Cores	No changeable options	Displays number of physical cores in processor.
Intel HT Technology	No changeable options	Reports if Intel Hyper-Threading Technology is supported by processor
Intel VT-x Technology	No changeable options	Reports if Intel VT-x Technology is supported by processor.
L1 Data Cache	No changeable options	Displays size of L1 Data Cache

BIOS Setting	Options	Description/Purpose
L1 Code Cache	No changeable options	Displays size of L1 Code Cache
L2 Cache	No changeable options	Displays size of L2 Cache.
L3 Cache	No changeable options	Displays size of L3 Cache.

3-4-4-5. IDE Configuration

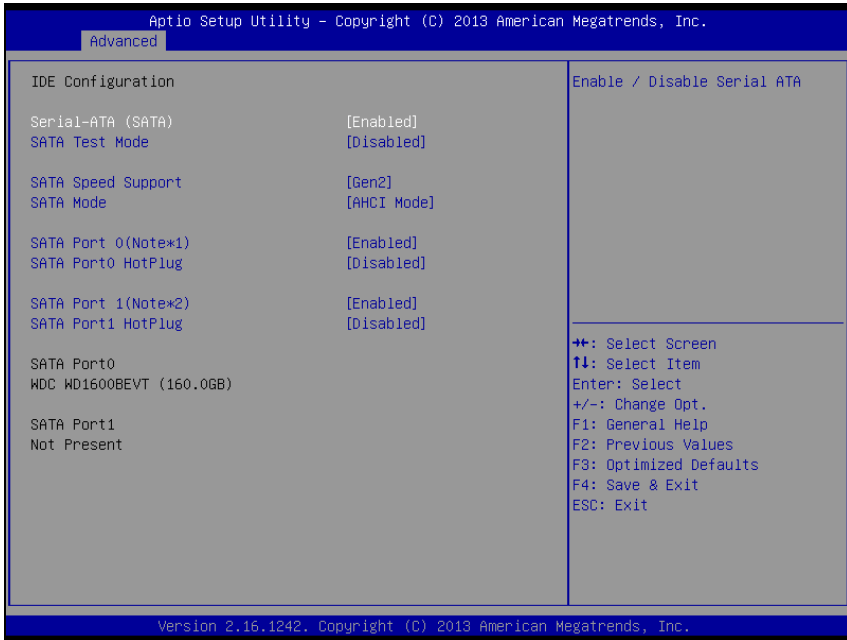

IDE Configuration Screen

BIOS Setting	Options	Description/Purpose
Serial-ATA Controller(s)	- Disabled - Enabled	Enable or disable SATA Device.
SATA Test Mode	- Disabled - Enabled	Enable or disable SATA Test Mode.
SATA Speed Support	- GEN1 - GEN2	<ul style="list-style-type: none"> ▪ Gen1 mode sets the device to 1.5 Gbit/s speed. ▪ Gen2 mode sets the device to 3 Gbit/s speed (in case it is compatible).
SATA Mode	- IDE mode - AHCI mode	<p>Configures SATA as follows.</p> <ul style="list-style-type: none"> ▪ IDE: Set SATA operation mode to IDE mode. ▪ AHCI: SATA works as AHCI (Advanced Host Controller Interface) mode for getting better performance.

BIOS Setting	Options	Description/Purpose
SATA Port 0(Note*1)	- Disabled - Enabled	Enable or disable SATA port 0 Device.
SATA Port 0 HotPlug	- Disabled - Enabled	Enable or disable SATA port 0 Device HotPlug
SATA Port 1(Note*2)	- Disabled - Enabled	Enable or disable SATA port 1 Device.
SATA Port 1 HotPlug	- Disabled - Enabled	Enable or disable SATA port 1 Device HotPlug
SATA Port 0	[drive]	Displays the drive installed on this SATA port 0. Shows [Empty] if no drive is installed. If mother board support RAID that will show ASMT109x- Conf (0.1GB)
SATA Port 1	[drive]	Displays the drive installed on this SATA port 1. Shows [Empty] if no drive is installed.

3-4-4-6. OS Selection

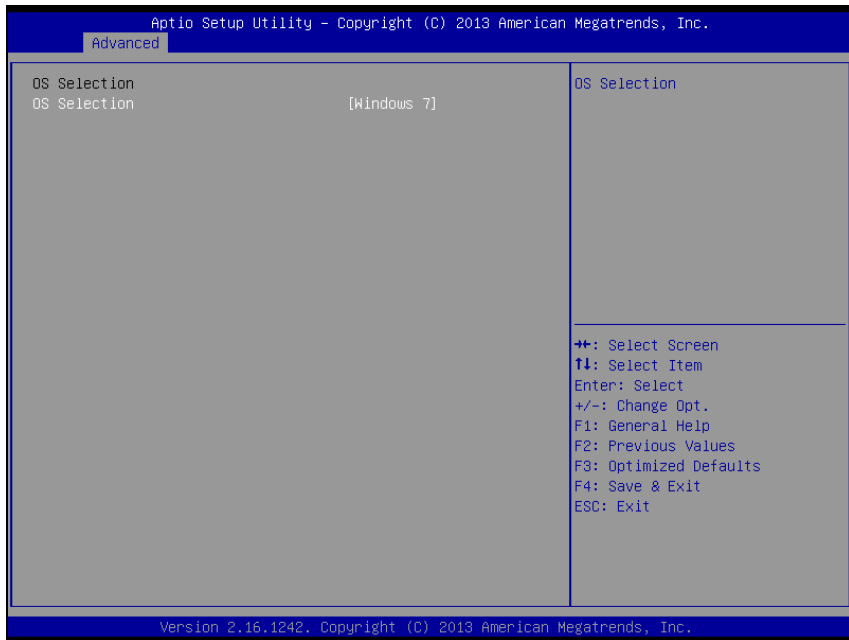

OS Selection Screen

BIOS Setting	Options	Description/Purpose
OS Selection	- Windows 8.x - Windows7	Operation System Selection

3-4-4-7. Voltage Adjustment Configuration



Voltage Adjustment Configuration Screen

BIOS Setting	Options	Description/Purpose
COM2 Select	- Disabled - 12V - 5V	Select COM2 Port voltage.
COM3 Select	- Disabled - 12V - 5V	Select COM3 Port voltage.
Cash drawer	- Cash drawer 12V - Cash drawer 24V	Select Cash drawer voltage.

3-4-4-8. CSM Configuration

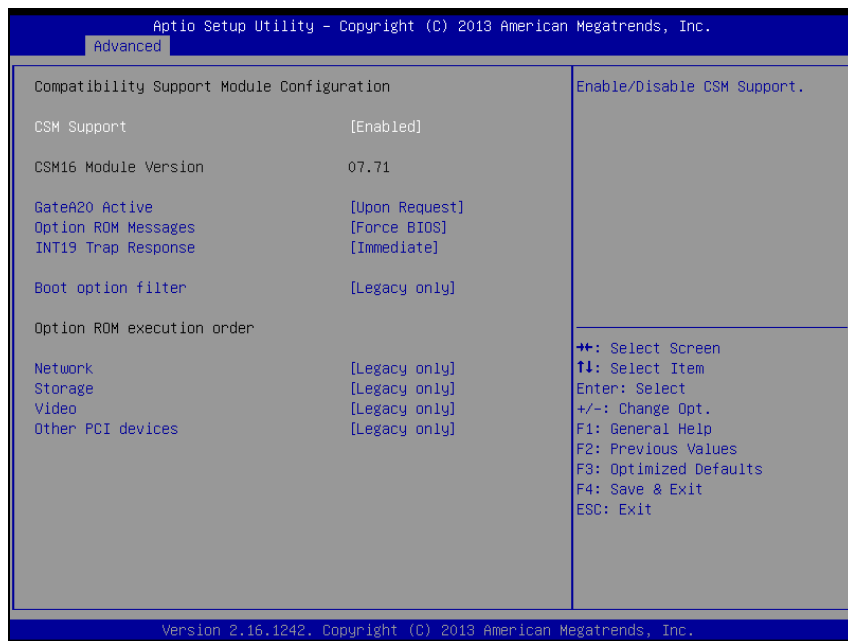

CSM Configuration Screen

BIOS Setting	Options	Description/Purpose
CSM Support	- Disabled - Enabled	Disable or Enable CSM support
CSM16 Module Version	No changeable options	Displays the current CSM (Compatibility Support Module) version.
GateA20 Active	- Upon Request - Always	Select Gate A20 operation mode. <ul style="list-style-type: none"> ▪ Upon Request: GA20 can be disabled using BIOS services. ▪ Always: do not allow disabling GA20; this option is useful when any RT code is executed above 1MB.

BIOS Setting	Options	Description/Purpose
Option ROM Messages	<ul style="list-style-type: none"> - Force BIOS - Keep Current 	Set display mode for Option ROM messages.
INT19 Trap Response	<ul style="list-style-type: none"> - Immediately - Postponed 	BIOS reaction on INT19 trapping by Option ROM. <ul style="list-style-type: none"> ▪ Immediate: Execute the trap right away. ▪ Postponed: Execute the trap during legacy boot.
Boot option filter	<ul style="list-style-type: none"> - UEFI and Legacy - Legacy only - UEFI only 	This option controls what kind of devices system can boot.
Network	<ul style="list-style-type: none"> - Do not launch - UEFI only - Legacy only - Legacy first - UEFI first 	Controls the execution of UEFI or Legacy PXE
Storage	<ul style="list-style-type: none"> - Do not launch - UEFI only - Legacy only - Legacy first - UEFI first 	Controls the execution of UEFI or Legacy Storage
Video	<ul style="list-style-type: none"> - Do not launch - UEFI only - Legacy only - Legacy first - UEFI first 	Controls the execution of UEFI and Legacy Video.
Other PCI devices	<ul style="list-style-type: none"> - UEFI first - Legacy only 	Select launch method for other PCI devices, such as NIC, mass storage or video card.

3-4-4-9. USB Configuration

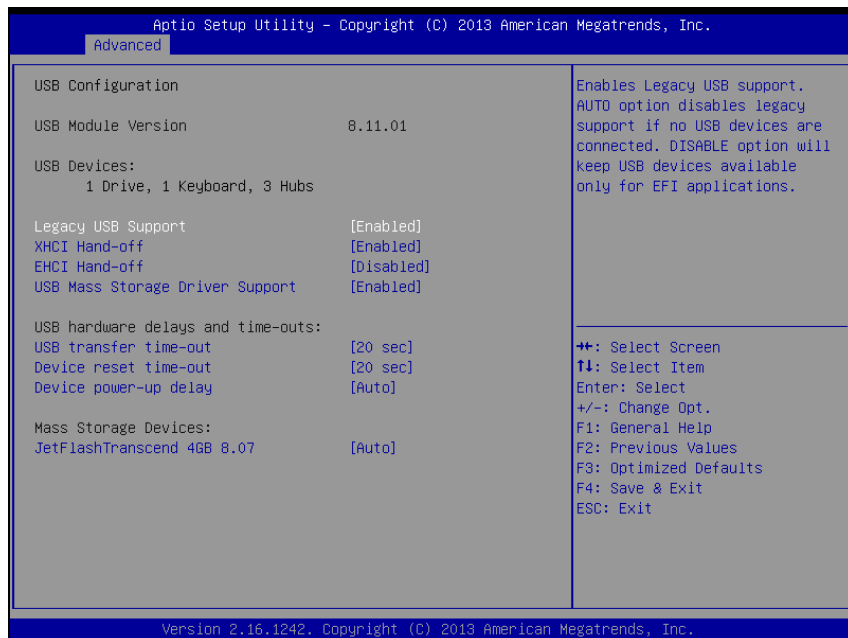

USB Configuration Screen

BIOS Setting	Options	Description/Purpose
USB Devices	No changeable options	Displays number of available USB devices.
Legacy USB Support	- Disabled - Enabled - Auto	Enables support for legacy USB.
USB3.0 Support	- Disabled - Enabled	Enable/Disable USB3.0 (XHCI) Controller support.
EHCI Hand-of	- Disabled - Enabled	This is a workaround for OSes without EHCI hand-off support.
USB Mass Storage Driver Support	- Disabled - Enabled	Enable/Disable USB mass storage driver support.

BIOS Setting	Options	Description/Purpose
USB transfer time-out	1/5/10/20 sec	The time-out value for Control, Bulk, and Interrupt transfers.
Device reset time-out	10/20/30/40 sec	USB mass storage device Start Unit command time-out.
Device power-up delay	- Auto - Manual	Maximum time the device will take before it properly reports itself to the Host Controller. “Auto” uses default value: for a Root port it is 100 ms, for a Hub port the delay is taken from Hub descriptor.
Device power-up delay in seconds	Multiple options ranging from 0 to 40	Delay range is 1..40 seconds, in one second increments
Mass Storage Devices:	- Auto - Floppy - Force FDD - Hard Disk - CD-ROM	Display the device name and choose the device emulation type.

3-4-4-10. Super IO Configuration



Super IO Configuration Screen

BIOS Setting	Options	Description/Purpose
[*Active*] Serial Port 1	Sub-menu	Set Parameters for COM1
[*Active*] Serial Port 2	Sub-menu	Set Parameters for COM2
[*Active*] Serial Port 3	Sub-menu	Set Parameters for COM3
[*Active*] Serial Port 4	Sub-menu	Set Parameters for COM4
[*Active*] Parallel Port	Sub-menu	Set Parameters for LPT port.
[*Active*] PS/2 Controller (KB&MS)	Sub-menu	Set Parameters for PS/2.

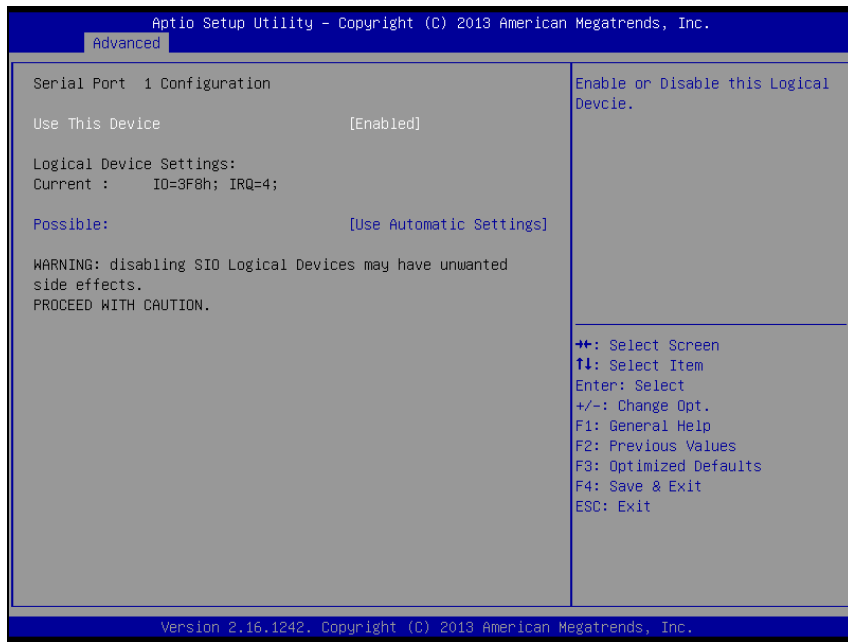

Serial Port 1 Configuration Screen

BIOS Setting	Options	Description/ Purpose
Use This Device	-Disabled -Enabled	Enable or disable serial port 1.
Logical device setting	No changeable options	Displays current settings of serial port 1.
Possible:	-Use Automatic Settings -IO=3F8h; IRQ=4 DMA -IO=3F8h; IRQ=3,4,5,6,7,9,10,11,12 DMA -IO=2F8h; IRQ=3,4,5,6,7,9,10,11,12 DMA -IO=3E8h; IRQ=3,4,5,6,7,9,10,11,12 DMA -IO=2E8h; IRQ=3,4,5,6,7,9,10,11,12 DMA	Select IRQ and I/O resource for the serial port 1.

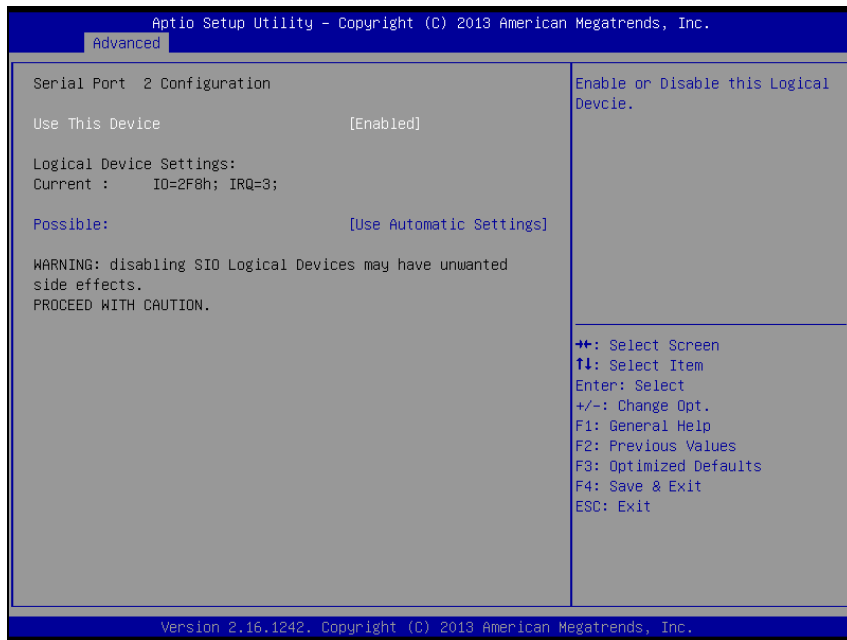

Serial Port 2 Configuration Screen

BIOS Setting	Options	Description/ Purpose
Use This Device	-Disabled -Enabled	Enable or disable serial port 2.
Logical device setting	No changeable options	Displays current settings of serial port 2.
Possible:	-Use Automatic Settings -IO=2F8h; IRQ=3 DMA -IO=3F8h; IRQ=3,4,5,6,7,9,10,11,12 DMA -IO=2F8h; IRQ=3,4,5,6,7,9,10,11,12 DMA -IO=3E8h; IRQ=3,4,5,6,7,9,10,11,12 DMA -IO=2E8h; IRQ=3,4,5,6,7,10,11,12 DMA	Select IRQ and I/O resource for the serial port 2

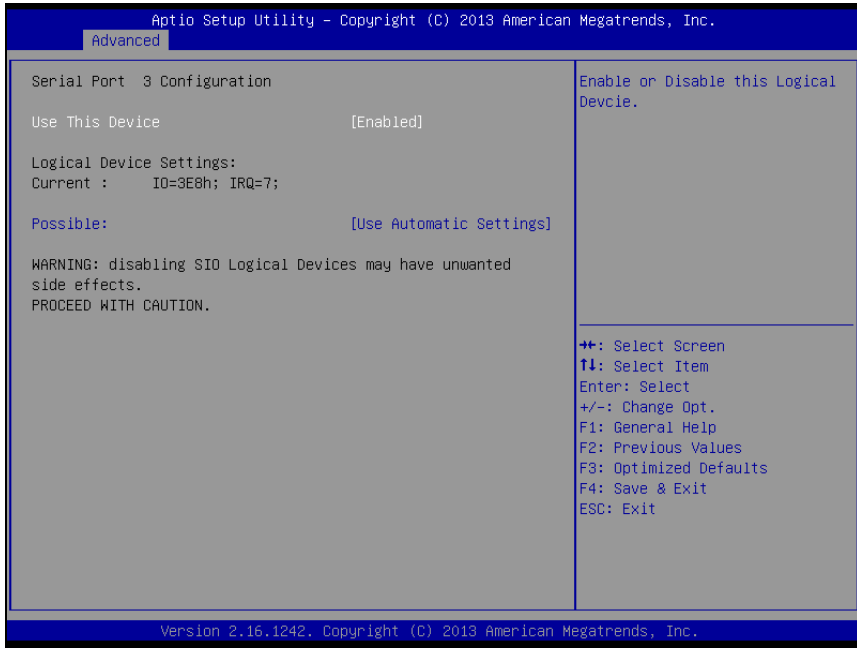

Serial Port 3 Configuration Screen

BIOS Setting	Options	Description/ Purpose
Use This Device	-Disabled -Enabled	Enable or disable serial port 3.
Logical device setting	No changeable options	Displays current settings of serial port 3.
Possible:	-Use Automatic Settings -IO=3E8h; IRQ=7 DMA -IO=3F8h; IRQ=3,4,5,6,7,9,10,11,12 DMA -IO=2F8h; IRQ=3,4,5,6,7,9,10,11,12 DMA -IO=3E8h; IRQ=3,4,5,6,7,9,10,11,12 DMA -IO=2E8h; IRQ=3,4,5,6,7,9,10,11,12 DMA -IO=2F0h; IRQ=3,4,5,6,7,9,10,11,12 DMA -IO=2E0h; IRQ=3,4,5,6,7,9,10,11,12 DMA	Select IRQ and I/O resource for the serial port 3

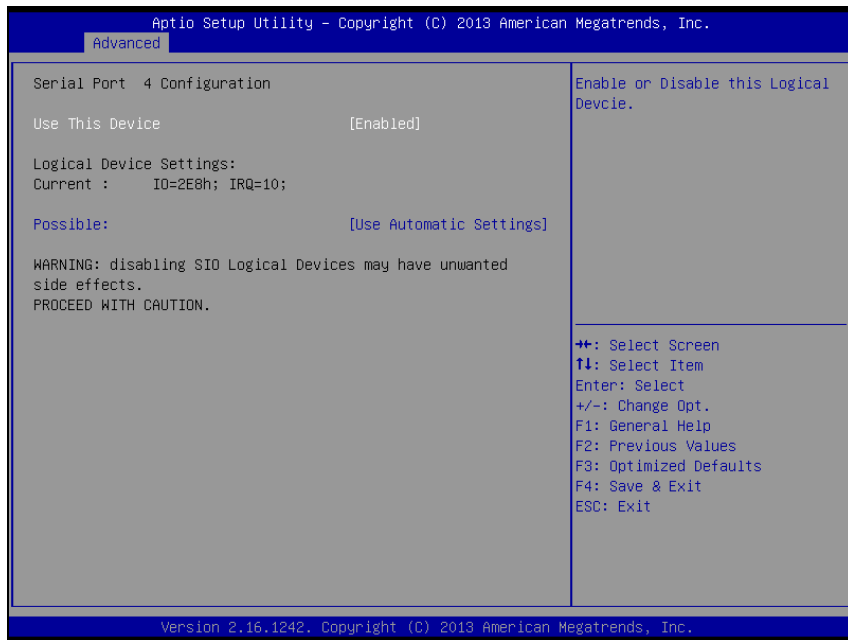

Serial Port 4 Configuration Screen

BIOS Setting	Options	Description/ Purpose
Use This Device	-Disabled -Enabled	Enable or disable serial port 4.
Logical device setting	No changeable options	Displays current settings of serial port 4.
Possible:	- Use Automatic Settings - IO=2E8h; IRQ=7 DMA - IO=3F8h; IRQ=3,4,5,6,7,9,10,11,12 DMA - IO=2F8h; IRQ=3,4,5,6,7,9,10,11,12 DMA - IO=3E8h; IRQ=3,4,5,6,7,9,10,11,12 DMA - IO=2E8h; IRQ=3,4,5,6,7,9,10,11,12 DMA - IO=2F0h; IRQ=3,4,5,6,7,9,10,11,12 DMA - IO=2E0h; IRQ=3,4,5,6,7,9,10,11,12 DMA	Select IRQ and I/O resource for the serial port 4

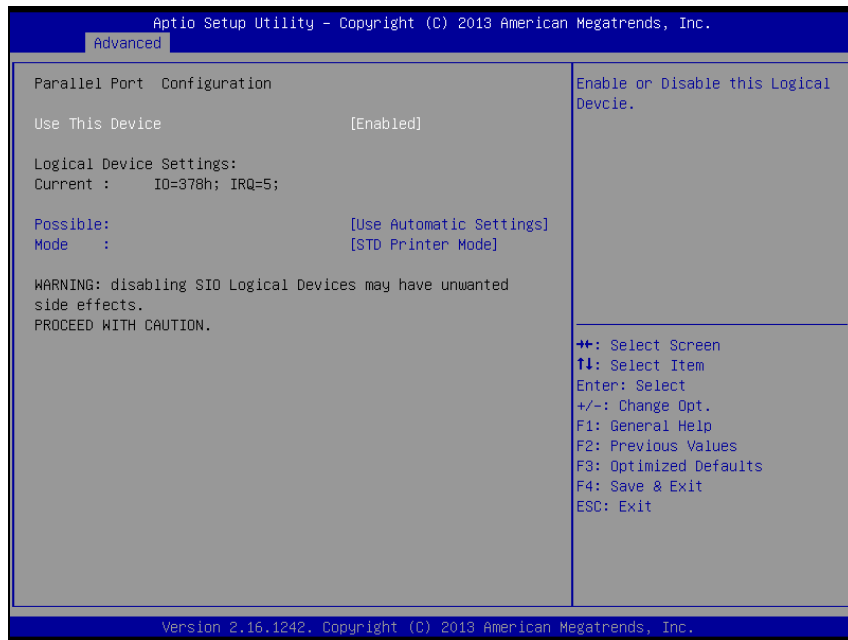

Parallel Port Configuration Screen

BIOS Setting	Options	Description/Purpose
Use This Device	-Disabled -Enabled	Enable or disable the printer port.
Logical device setting	No changeable options	Displays current settings of the printer port.
Possible:	-Use Automatic Settings -IO=378h; IRQ=5 -IO=378h; IRQ=5,6,7,9,10,11,12 -IO=278h; IRQ=5,6,7,9,10,11,12 -IO=3BCh; IRQ=5,6,7,9,10,11,12	Select IRQ and I/O resource for the printer port.

BIOS Setting	Options	Description/Purpose
Mode	-STD Printer Mode -SPP Mode -EPP-1.9 and SPP Mode -EPP-1.7 and SPP Mode -ECP Mode -ECP and EPP 1.9 Mode -ECP and EPP 1.7 Mode	Selects the mode for the parallel port. Not available if the parallel port is disabled. <ul style="list-style-type: none">▪ SPP is Standard Parallel Port mode, a bi-directional mode for printers.▪ EPP is Enhanced Parallel Port mode, a high-speed bi-directional mode for non-printer peripherals.▪ ECP is Enhanced Capability Port mode, a high-speed bi-directional mode for printers and scanners.

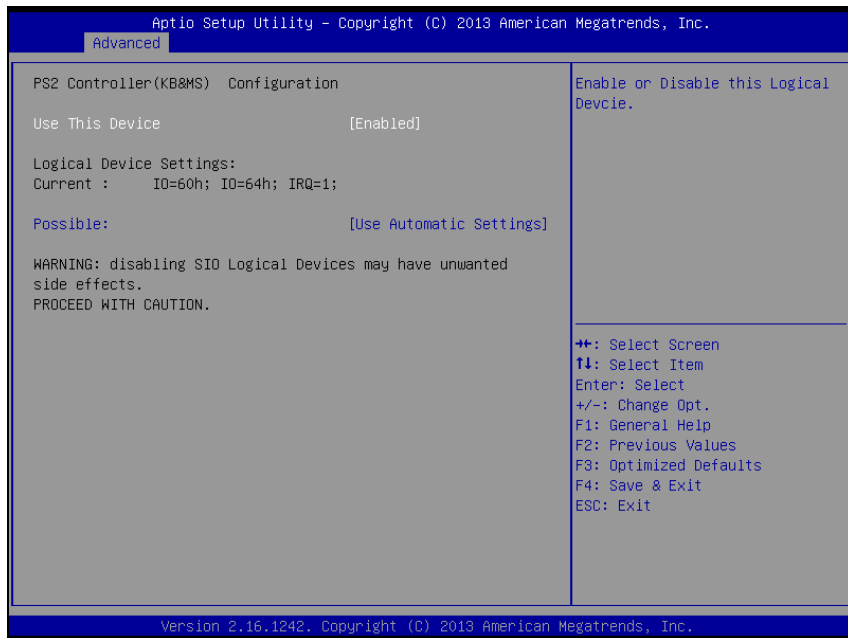

PS2 Controller (KB & MS) Configuration Screen

BIOS Setting	Options	Description/Purpose
Use This Device	-Disabled -Enabled	Enable or disable the PS2.
Logical device setting Current	No changeable options	Displays current settings of the printer port.
Possible:	- Use Automatic Settings -IO=60h; IO=60h; IRQ=1	Select IRQ and I/O resource for the printer port.

3-4-5. Chipset

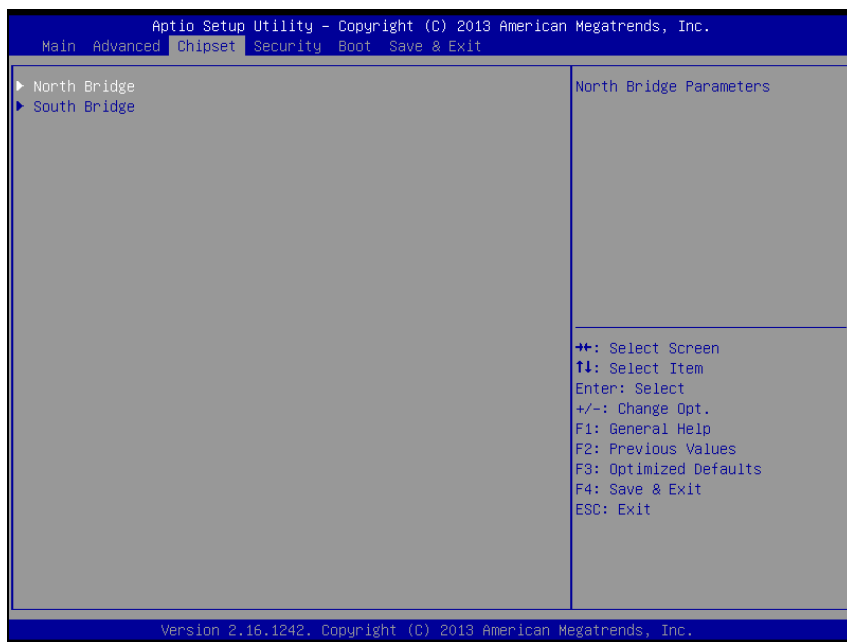

Chipset Screen

BIOS Setting	Options	Description/Purpose
North Bridge	Sub-menu	Sets Parameter for (North Bridge) configuration.
South Bridge	Sub-menu	Sets Parameter for (South Bridge) configuration.

3-4-5-1. North Bridge

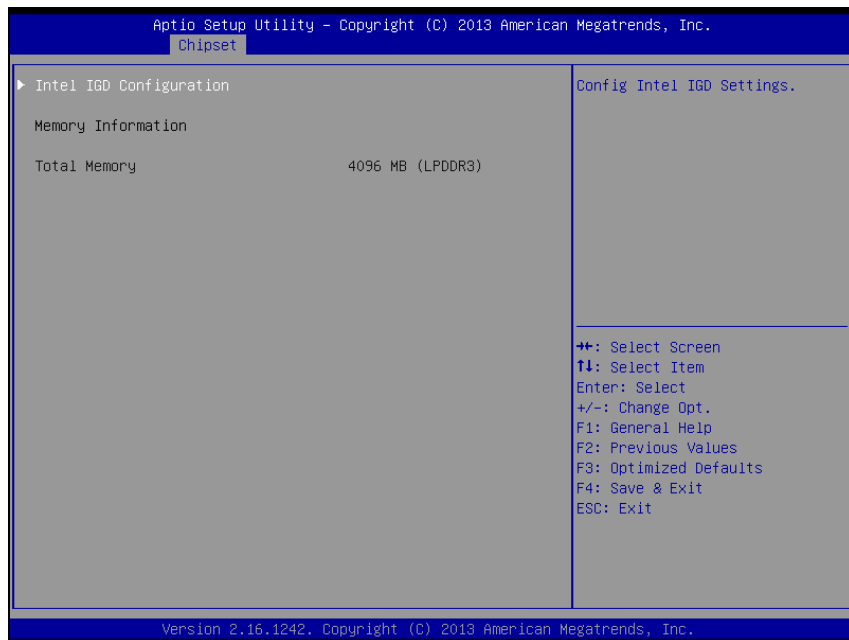

North Bridge Screen

BIOS Setting	Options	Description/Purpose
Intel IGD Configuration	Sub-menu	Configure Graphic Settings.
Memory Information	No changeable options	Displays the DRAM information on platform.
Total Memory	No changeable options	Displays the DRAM size

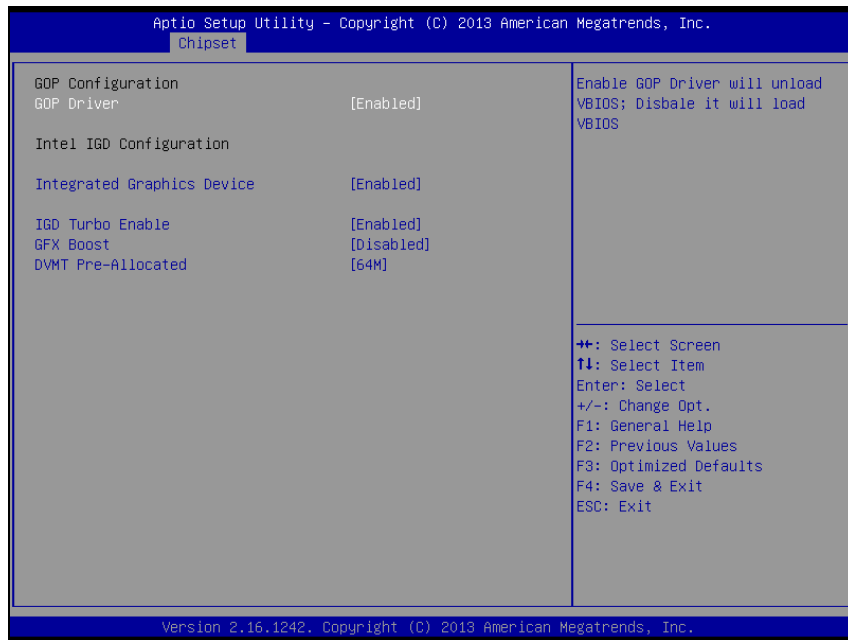

Intel IGD Configuration Screen

BIOS Setting	Options	Description/Purpose
GOP Driver	- Disabled - Enabled	Enable or disable GOP Driver for UEFI OS
Intel IGD Configuration	No changeable options	Displays the IGD information on platform.
Integrated Graphics Device	- Disabled - Enabled	<ul style="list-style-type: none"> ▪ Enable: Enable Integrated Graphics Device (IGD) when selected as the Primary Video Adaptor. ▪ Disable: Always disable IGD"
IGD Turbo Enable	- Disabled - Enabled	Enable or disable IGD Turbo
GFX Boost	- Disabled - Enabled	Enable or disable GFX Boost accelerated graphics processing

BIOS Setting	Options	Description/Purpose
DVMT Pre-Allocated	- 32M - 64M - 96M - 128M - 256M - 512M	Select DVMT 5.0 Pre-Allocated (Fixed) Graphics Memory size used by the Internal Graphics Device.

3-4-5-2. South Bridge

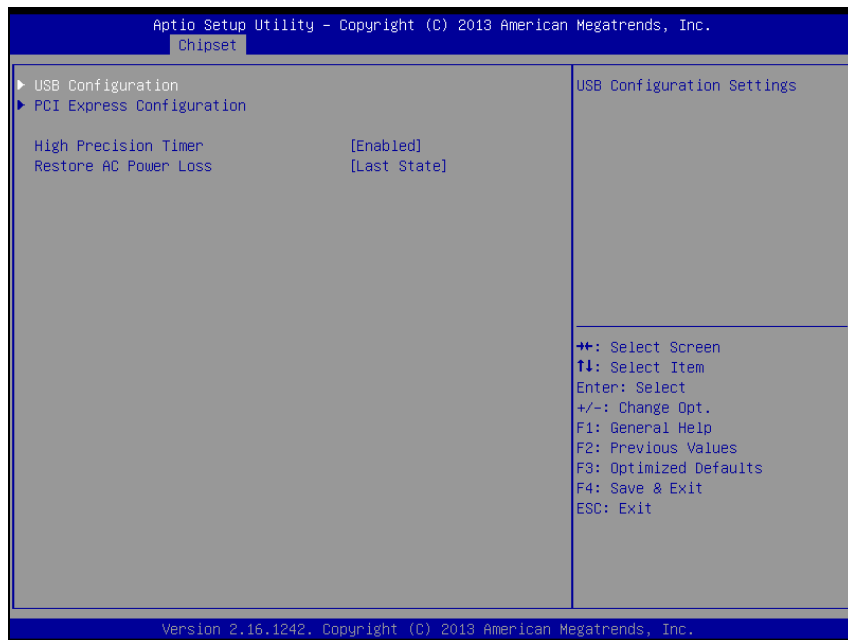

South Bridge Screen

BIOS Setting	Options	Description/Purpose
USB Configuration	Sub-menu	Configure USB parameters.
PCI Express Configuration	Sub-menu	Configure PCH PCIE parameters
High Precision Timer	- Disabled - Enabled	Enable or disable the HPET (High Precision Event Timer)

BIOS Setting	Options	Description/Purpose
Restore AC Power Loss	<ul style="list-style-type: none">- Power Off- Power On- Last State	<p>Select AC power state when power is re-applied after a power failure.</p> <ul style="list-style-type: none">▪ Power Off keeps the power off till the power button is pressed.▪ Power On makes system power on after restores AC power to the board.▪ Last State brings system back to the last power state before AC remove.

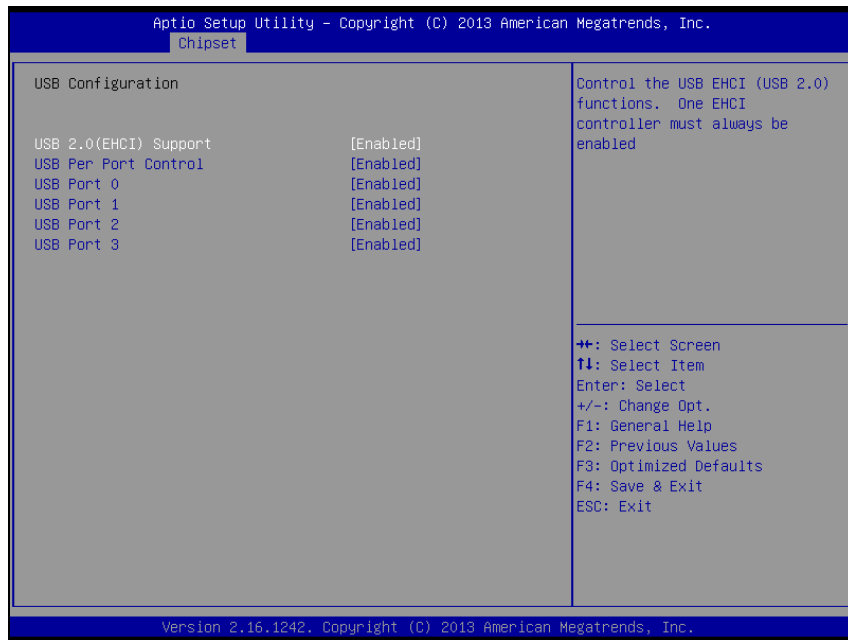

USB Configuration Screen

BIOS Setting	Options	Description/Purpose
USB 2.0(EHCI) Support	- Disabled - Enabled	(XHCI Mode need set disabled.) Enables Enhanced Host Controller Interface 1 for high-speed USB functions (USB 2.0).
USB Per Port Control	- Disabled - Enabled	Enabled or Disabled per USB port
USB Port 0	- Disabled - Enabled	Enabled or Disabled USB port 0
USB Port 1	- Disabled - Enabled	Enabled or Disabled USB port 1
USB Port 2	- Disabled - Enabled	Enabled or Disabled USB port 2
USB Port 3	- Disabled - Enabled	Enabled or Disabled USB port 3



PCI Express Configuration Screen

BIOS Setting	Options	Description/Purpose
PCI Express Port 2(For mini PCI-E)	- Disabled - Enabled	Enables or Disables PCI Express port 2.
speed	- Auto - Gen1 - Gen2	Selects PCI Express port 2 speed.
PCI Express Port 3 (For RTL8111)	- Disabled - Enabled	Enables or Disables PCI Express port 3.
Speed	- Auto - Gen1 - Gen2	Selects PCI Express port 3 speed.

3-4-6. Security

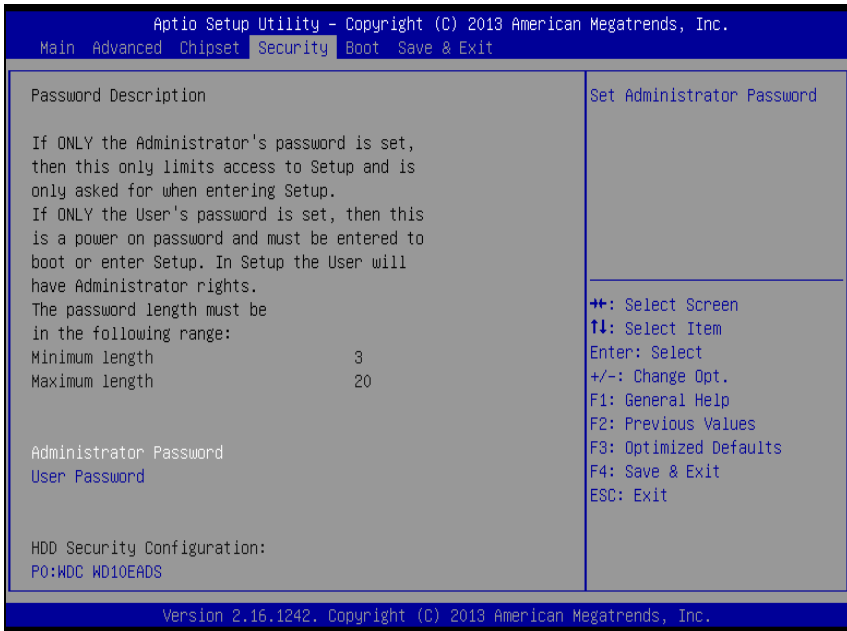

Security Screen

BIOS Setting	Options	Description/Purpose
Administrator Password	Password can be 3-20 alphanumeric characters.	Specifies the administrator password.
User Password	Password can be 3-20 alphanumeric characters.	Specifies the user password.
HDD Security Configuration:	Sub-menu	Set HDD password.

3-4-7. Boot

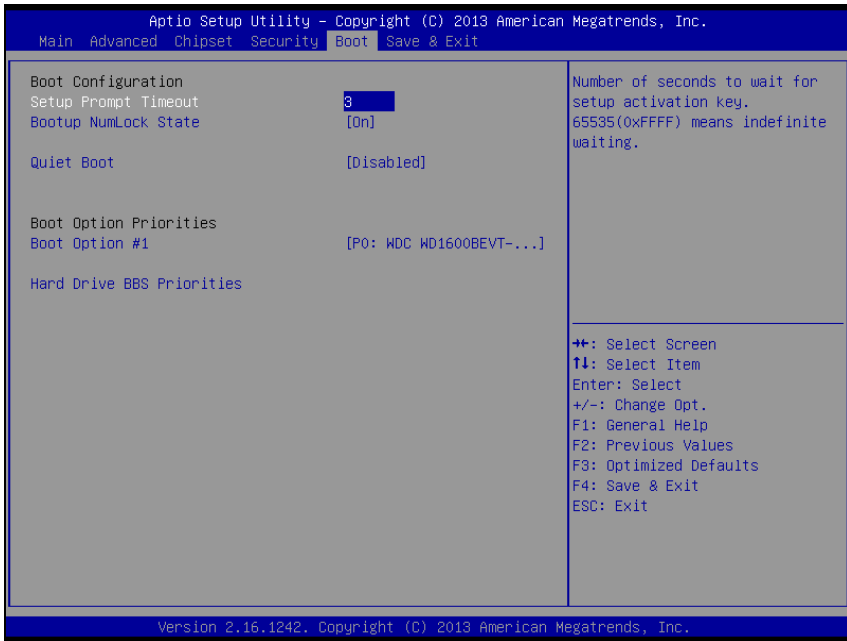

Boot Screen

BIOS Setting	Options	Description/Purpose
Setup Prompt Timeout	Numeric	Number of seconds to wait for setup activation key.
Bootup NumLock State	- On - Off	Specifies the power-on state of the NumLock Key.
Quiet Boot	- Disabled - Enabled	Enable/Disable Quiet Boot Options
Boot Option #1~#n	- [Drive(s)] - Disabled	Allows setting boot option listed in Hard Drive BBS Priorities.
Hard Drive BBS Priorities	Sub-Menu	Allow user to select boot order of available drive(s)

3-4-7-1. Hard Drive BBS Priorities

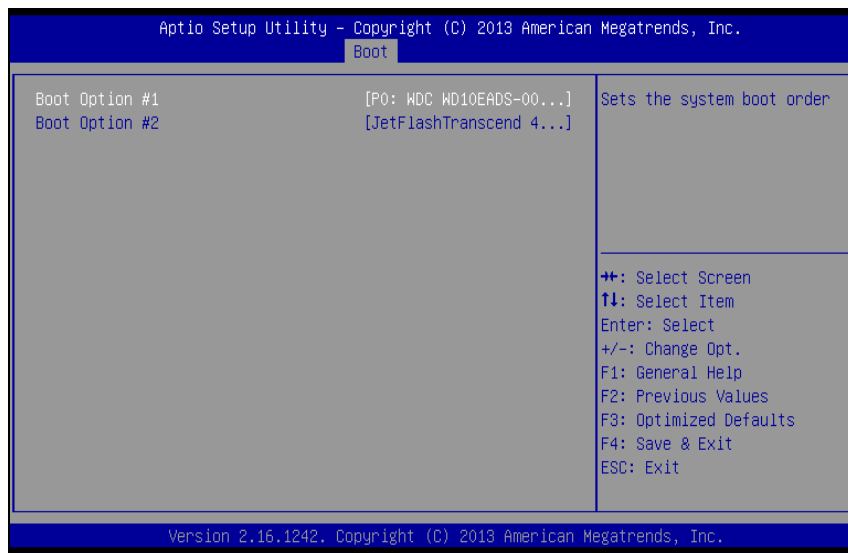

Hard Drive BBS Priorities Screen

BIOS Setting	Options	Description/Purpose
Boot Option #1 - #n	- [Drive(s)] - Disabled	Change the boot order of available drive(s).

3-4-8. Save & Exit

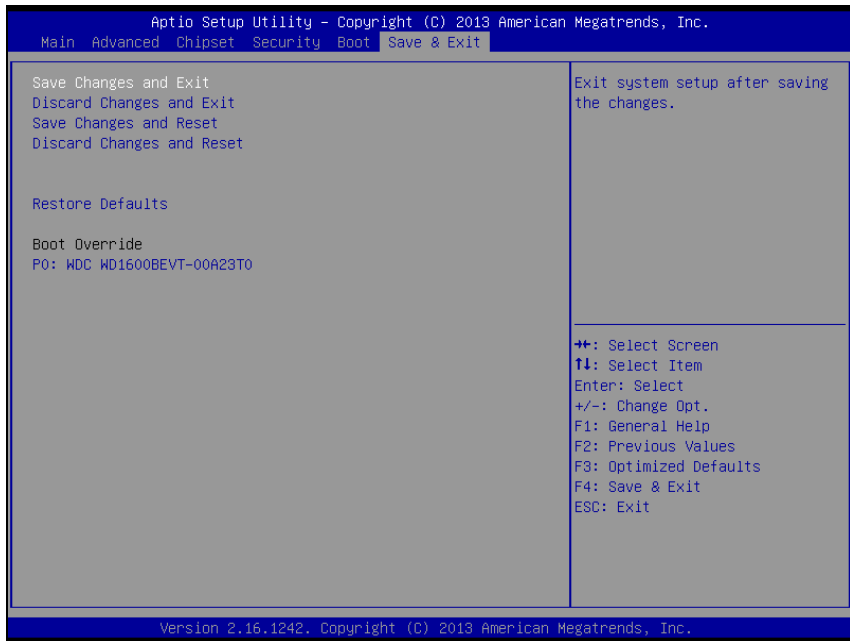

Save & Exit Screen

BIOS Setting	Options	Description/Purpose
Save Changes and Exit	No changeable options	Exits and saves the changes in NVRAM.
Discard Changes and Exit	No changeable options	Exits without saving any changes made in BIOS settings.
Save Changes and Reset	No changeable options	Saves the changes in NVRAM and resets.
Discard Changes and Reset	No changeable options	Resets without saving any changes made in BIOS settings.
Restore Defaults	No changeable options	Loads the optimized defaults for BIOS settings.
Boot Override	- [Drive(s)]	Forces to boot from selected [drive(s)].

3-5. WATCHDOG TIMER CONFIGURATION

The I/O port address of the watchdog timer is 2E (hex) and 2F (hex). 2E (hex) is the address port. 2F (hex) is the data port. User must first assign the address of register by writing address value into address port 2E (hex), then write/read data to/from the assigned register through data port 2F (hex).

3-5-1. Configuration Sequence

To program F81866 configuration registers, the following configuration sequence must be followed:

1. Enter the extended function mode

To place the chip into the Extended Function Mode, two successive writes of 0x87 must be applied to Extended Function Enable Registers (EFERs, i.e. 2Eh or 4Eh).

2. Configure the configuration registers

The chip selects the Logical Device and activates the desired Logical Devices through Extended Function Index Register (EFIR) and Extended Function Data Register (EFDR). The EFIR is located at the same address as the EFER, and the EFDR is located at address (EFIR+1). First, write the Logical Device Number (i.e. 0x07) to the EFIR and then write the number of the desired Logical Device to the EFDR. If accessing the Chip (Global) Control Registers, this step is not required. Secondly, write the address of the desired configuration register within the Logical Device to the EFIR and then write (or read) the desired configuration register through the EFDR.

3. Exit the extended function mode

To exit the Extended Function Mode, writing 0xAA to the EFER is required. Once the chip exits the Extended Function Mode, it is in the normal running mode and is ready to enter the configuration mode.

3-5-2. Code Example for Watchdog Timer

Enable watchdog timer and set the timeout interval as 30 seconds.

```

;----- Enter to extended function mode -----
mov    dx,    2eh
mov    al,    87h
out    dx,    al
out    dx,    al
;----- Select Logical Device 7 of watchdog timer -----
mov    al,    07h
out    dx,    al
inc    dx
mov    al,    07h
out    dx,    al
;----- Enable Watch dog feature -----
mov    al,    030h
out    dx,    al
inc    dx
mov    al,    01h
out    dx,    al
;----- Enable Watch PME-----
dec    dx
mov    al,    0FAh
out    dx,    al
inc    dx
in     al,    dx
and    al,    51h
out    dx,    al
;----- Set second as counting unit -----
dec    dx
mov    al,    0f5h
out    dx,    al
inc    dx

```

```
in    al,    dx
and   al,    30h
out   dx,    al
;----- Set timeout interval as 30seconds and start counting -----
dec   dx
mov   al,    0f6h
out   dx,    al
inc   dx
mov   al,    1Eh
out   dx,    al
;----- Exit the extended function mode -----
dec   dx
mov   al,    0aah
out   dx,    al
```

3-6. BIOS UPDATE INSTRUCTIONS

3-6-1. Before System BIOS UPDATE

1. Prepare a bootable media (e.g. USB storage device) which can boot system to DOS prompt.
2. Download and save the BIOS file (e.g. 31220PD1.bin) to the bootable device.
3. Copy AMI flash utility – AFUDOS.exe (V3.03) into the bootable device
4. Make sure the target system can first boot to the bootable device.
 - a. Connect the bootable USB device.
 - b. Turn on the computer and press or <Esc> key during boot to enter BIOS setup menu.
 - c. System will go into the BIOS setup menu.
 - d. Select [Boot] menu as the picture shows below.
 - e. Select [Hard Drive BBS Priorities], set the USB bootable device as the 1st boot device.
 - f. Press <F4> key to save configuration and exit the BIOS setup menu.



3-6-2. AFUDOS Command for System BIOS Update

AFUDOS.exe is aforementioned AMI firmware update utility; the command line is shown as below:

AFUDOS <ROM File Name> [option1] [option2]...

You can type [AFUDOS /?](#) to see all the definition of each control options. The recommended options for BIOS ROM update consist of following parameters:

[/P](#): program main BIOS image

[/B](#): program Boot Block

[/N](#): program NVRAM

[/X](#): don't check ROM ID

3-6-3. BIOS Update Procedure

1. Use the bootable USB device to boot up system into the MS-DOS command prompt
2. Type in `AFUDOS 3122xxxx.bin /p /b /n /x` and press enter to start the flash procedure

Note: `xxxx` means the BIOS revision part, ex. 0PD1...

3. During the update procedure, you will see the BIOS update process status and its percentage. **Beware!** Do not turn off or reset your computer before the update is complete, or it may crash the BIOS ROM and make the system unable to boot up next time. The whole update process may take up to 3 minutes.
4. After the BIOS update is complete, the messages from AFUDOS utility should be like the figure shown below.

```
C:\AFU\3.04>afudos.exe 31220PD1.BIN /p /b /n /x
+-----+
|                                     |
|             AMI Firmware Update Utility v3.04.00             |
|       Copyright (C)2012 American Megatrends Inc. All Rights Reserved.       |
+-----+
Reading flash ..... done
- ME Data Size checking . ok
- FFS checksums ..... ok
Erasing Boot Block ..... done
Updating Boot Block ..... done
Verifying Boot Block ..... done
Erasing Main Block ..... done
Updating Main Block ..... done
Verifying Main Block ..... done
Erasing NURAM Block ..... done
Updating NURAM Block ..... done
Verifying NURAM Block ..... done

C:\AFU\3.04>
C:\AFU\3.04>_
```

5. You can restart the system and boot up with new BIOS now
6. Update is complete after restart
7. Verify during the following boot that BIOS version displayed at the initialization screen has changed.



Version 2.16.1242. Copyright (C) 2013 American Megatrends, Inc.
BIOS Date: 04/09/2014 11:37:46 Ver: 31220PD1
Press or <ESC> to enter setup.

B2

3-7. SYSTEM RESOURCE MAP

3-7-1. Interrupt Map

IRQ	ASSIGNMENT
0	System timer
1	Standard PS/2 Keyboard
3	Communications Port (COM2)
4	Communications Port (COM1)
5	Printer Port (LPT1)
7	Communications Port (COM3)
7	Communications Port (COM4)
8	High precision event timer
16	Intel® Pentium® processor N- and J-series / Intel® Celeron® processor N- and J-series PCI Express - Root Port 1 - 0F48
17	Intel® Pentium® processor N- and J-series / Intel® Celeron® processor N- and J-series PCI Express - Root Port 2 - 0F4A
18	Intel® Pentium® processor N- and J-series / Intel® Celeron® processor N- and J-series PCI Express - Root Port 3 - 0F4C
19	Intel® Pentium® processor N- and J-series / Intel® Celeron® processor N- and J-series PCI Express - Root Port 4 - 0F4E
19	Intel® Pentium® processor N- and J-series / Intel® Celeron® processor N- and J-series AHCI - 0F23
81	Microsoft ACPI-Compliant System
82	Microsoft ACPI-Compliant System
83	Microsoft ACPI-Compliant System
84	Microsoft ACPI-Compliant System
85	Microsoft ACPI-Compliant System
86	Microsoft ACPI-Compliant System
87	Microsoft ACPI-Compliant System
88	Microsoft ACPI-Compliant System
89	Microsoft ACPI-Compliant System
90	Microsoft ACPI-Compliant System

IRQ	ASSIGNMENT
91	Microsoft ACPI-Compliant System
92	Microsoft ACPI-Compliant System
93	Microsoft ACPI-Compliant System
94	Microsoft ACPI-Compliant System
95	Microsoft ACPI-Compliant System
96	Microsoft ACPI-Compliant System
97	Microsoft ACPI-Compliant System
98	Microsoft ACPI-Compliant System
99	Microsoft ACPI-Compliant System
100	Microsoft ACPI-Compliant System
101	Microsoft ACPI-Compliant System
102	Microsoft ACPI-Compliant System
103	Microsoft ACPI-Compliant System
104	Microsoft ACPI-Compliant System
105	Microsoft ACPI-Compliant System
106	Microsoft ACPI-Compliant System
107	Microsoft ACPI-Compliant System
108	Microsoft ACPI-Compliant System
109	Microsoft ACPI-Compliant System
110	Microsoft ACPI-Compliant System
111	Microsoft ACPI-Compliant System
112	Microsoft ACPI-Compliant System
113	Microsoft ACPI-Compliant System
114	Microsoft ACPI-Compliant System
115	Microsoft ACPI-Compliant System
116	Microsoft ACPI-Compliant System
117	Microsoft ACPI-Compliant System
118	Microsoft ACPI-Compliant System
119	Microsoft ACPI-Compliant System
120	Microsoft ACPI-Compliant System
121	Microsoft ACPI-Compliant System
122	Microsoft ACPI-Compliant System

IRQ	ASSIGNMENT
123	Microsoft ACPI-Compliant System
124	Microsoft ACPI-Compliant System
125	Microsoft ACPI-Compliant System
126	Microsoft ACPI-Compliant System
127	Microsoft ACPI-Compliant System
128	Microsoft ACPI-Compliant System
129	Microsoft ACPI-Compliant System
130	Microsoft ACPI-Compliant System
131	Microsoft ACPI-Compliant System
132	Microsoft ACPI-Compliant System
133	Microsoft ACPI-Compliant System
134	Microsoft ACPI-Compliant System
135	Microsoft ACPI-Compliant System
136	Microsoft ACPI-Compliant System
137	Microsoft ACPI-Compliant System
138	Microsoft ACPI-Compliant System
139	Microsoft ACPI-Compliant System
140	Microsoft ACPI-Compliant System
141	Microsoft ACPI-Compliant System
142	Microsoft ACPI-Compliant System
143	Microsoft ACPI-Compliant System
144	Microsoft ACPI-Compliant System
145	Microsoft ACPI-Compliant System
146	Microsoft ACPI-Compliant System
147	Microsoft ACPI-Compliant System
148	Microsoft ACPI-Compliant System
149	Microsoft ACPI-Compliant System
150	Microsoft ACPI-Compliant System
151	Microsoft ACPI-Compliant System
152	Microsoft ACPI-Compliant System
153	Microsoft ACPI-Compliant System
154	Microsoft ACPI-Compliant System

IRQ	ASSIGNMENT
155	Microsoft ACPI-Compliant System
156	Microsoft ACPI-Compliant System
157	Microsoft ACPI-Compliant System
158	Microsoft ACPI-Compliant System
159	Microsoft ACPI-Compliant System
160	Microsoft ACPI-Compliant System
161	Microsoft ACPI-Compliant System
162	Microsoft ACPI-Compliant System
163	Microsoft ACPI-Compliant System
164	Microsoft ACPI-Compliant System
165	Microsoft ACPI-Compliant System
166	Microsoft ACPI-Compliant System
167	Microsoft ACPI-Compliant System
168	Microsoft ACPI-Compliant System
169	Microsoft ACPI-Compliant System
170	Microsoft ACPI-Compliant System
171	Microsoft ACPI-Compliant System
172	Microsoft ACPI-Compliant System
173	Microsoft ACPI-Compliant System
174	Microsoft ACPI-Compliant System
175	Microsoft ACPI-Compliant System
176	Microsoft ACPI-Compliant System
177	Microsoft ACPI-Compliant System
178	Microsoft ACPI-Compliant System
179	Microsoft ACPI-Compliant System
180	Microsoft ACPI-Compliant System
181	Microsoft ACPI-Compliant System
182	Microsoft ACPI-Compliant System
183	Microsoft ACPI-Compliant System
184	Microsoft ACPI-Compliant System
185	Microsoft ACPI-Compliant System
186	Microsoft ACPI-Compliant System

IRQ	ASSIGNMENT
187	Microsoft ACPI-Compliant System
188	Microsoft ACPI-Compliant System
189	Microsoft ACPI-Compliant System
190	Microsoft ACPI-Compliant System
191	Microsoft ACPI-Compliant System
256	Microsoft ACPI-Compliant System
257	Microsoft ACPI-Compliant System
258	Microsoft ACPI-Compliant System
259	Microsoft ACPI-Compliant System
260	Microsoft ACPI-Compliant System
261	Microsoft ACPI-Compliant System
262	Microsoft ACPI-Compliant System
263	Microsoft ACPI-Compliant System
264	Microsoft ACPI-Compliant System
265	Microsoft ACPI-Compliant System
266	Microsoft ACPI-Compliant System
267	Microsoft ACPI-Compliant System
268	Microsoft ACPI-Compliant System
269	Microsoft ACPI-Compliant System
270	Microsoft ACPI-Compliant System
271	Microsoft ACPI-Compliant System
272	Microsoft ACPI-Compliant System
273	Microsoft ACPI-Compliant System
274	Microsoft ACPI-Compliant System
275	Microsoft ACPI-Compliant System
276	Microsoft ACPI-Compliant System
277	Microsoft ACPI-Compliant System
278	Microsoft ACPI-Compliant System
279	Microsoft ACPI-Compliant System
280	Microsoft ACPI-Compliant System
281	Microsoft ACPI-Compliant System
282	Microsoft ACPI-Compliant System

IRQ	ASSIGNMENT
283	Microsoft ACPI-Compliant System
284	Microsoft ACPI-Compliant System
285	Microsoft ACPI-Compliant System
286	Microsoft ACPI-Compliant System
287	Microsoft ACPI-Compliant System
288	Microsoft ACPI-Compliant System
289	Microsoft ACPI-Compliant System
290	Microsoft ACPI-Compliant System
291	Microsoft ACPI-Compliant System
292	Microsoft ACPI-Compliant System
293	Microsoft ACPI-Compliant System
294	Microsoft ACPI-Compliant System
295	Microsoft ACPI-Compliant System
296	Microsoft ACPI-Compliant System
297	Microsoft ACPI-Compliant System
298	Microsoft ACPI-Compliant System
299	Microsoft ACPI-Compliant System
300	Microsoft ACPI-Compliant System
301	Microsoft ACPI-Compliant System
302	Microsoft ACPI-Compliant System
303	Microsoft ACPI-Compliant System
304	Microsoft ACPI-Compliant System
305	Microsoft ACPI-Compliant System
306	Microsoft ACPI-Compliant System
307	Microsoft ACPI-Compliant System
308	Microsoft ACPI-Compliant System
309	Microsoft ACPI-Compliant System
310	Microsoft ACPI-Compliant System
311	Microsoft ACPI-Compliant System
312	Microsoft ACPI-Compliant System
313	Microsoft ACPI-Compliant System
314	Microsoft ACPI-Compliant System

IRQ	ASSIGNMENT
315	Microsoft ACPI-Compliant System
316	Microsoft ACPI-Compliant System
317	Microsoft ACPI-Compliant System
318	Microsoft ACPI-Compliant System
319	Microsoft ACPI-Compliant System
320	Microsoft ACPI-Compliant System
321	Microsoft ACPI-Compliant System
322	Microsoft ACPI-Compliant System
323	Microsoft ACPI-Compliant System
324	Microsoft ACPI-Compliant System
325	Microsoft ACPI-Compliant System
326	Microsoft ACPI-Compliant System
327	Microsoft ACPI-Compliant System
328	Microsoft ACPI-Compliant System
329	Microsoft ACPI-Compliant System
330	Microsoft ACPI-Compliant System
331	Microsoft ACPI-Compliant System
332	Microsoft ACPI-Compliant System
333	Microsoft ACPI-Compliant System
334	Microsoft ACPI-Compliant System
335	Microsoft ACPI-Compliant System
336	Microsoft ACPI-Compliant System
337	Microsoft ACPI-Compliant System
338	Microsoft ACPI-Compliant System
339	Microsoft ACPI-Compliant System
340	Microsoft ACPI-Compliant System
341	Microsoft ACPI-Compliant System
342	Microsoft ACPI-Compliant System
343	Microsoft ACPI-Compliant System
344	Microsoft ACPI-Compliant System
345	Microsoft ACPI-Compliant System
346	Microsoft ACPI-Compliant System

IRQ	ASSIGNMENT
347	Microsoft ACPI-Compliant System
348	Microsoft ACPI-Compliant System
349	Microsoft ACPI-Compliant System
350	Microsoft ACPI-Compliant System
351	Microsoft ACPI-Compliant System
352	Microsoft ACPI-Compliant System
353	Microsoft ACPI-Compliant System
354	Microsoft ACPI-Compliant System
355	Microsoft ACPI-Compliant System
356	Microsoft ACPI-Compliant System
357	Microsoft ACPI-Compliant System
358	Microsoft ACPI-Compliant System
359	Microsoft ACPI-Compliant System
360	Microsoft ACPI-Compliant System
361	Microsoft ACPI-Compliant System
362	Microsoft ACPI-Compliant System
363	Microsoft ACPI-Compliant System
364	Microsoft ACPI-Compliant System
365	Microsoft ACPI-Compliant System
366	Microsoft ACPI-Compliant System
367	Microsoft ACPI-Compliant System
368	Microsoft ACPI-Compliant System
369	Microsoft ACPI-Compliant System
370	Microsoft ACPI-Compliant System
371	Microsoft ACPI-Compliant System
372	Microsoft ACPI-Compliant System
373	Microsoft ACPI-Compliant System
374	Microsoft ACPI-Compliant System
375	Microsoft ACPI-Compliant System
376	Microsoft ACPI-Compliant System
377	Microsoft ACPI-Compliant System
378	Microsoft ACPI-Compliant System

IRQ	ASSIGNMENT
379	Microsoft ACPI-Compliant System
380	Microsoft ACPI-Compliant System
381	Microsoft ACPI-Compliant System
382	Microsoft ACPI-Compliant System
383	Microsoft ACPI-Compliant System
384	Microsoft ACPI-Compliant System
385	Microsoft ACPI-Compliant System
386	Microsoft ACPI-Compliant System
387	Microsoft ACPI-Compliant System
388	Microsoft ACPI-Compliant System
389	Microsoft ACPI-Compliant System
390	Microsoft ACPI-Compliant System
391	Microsoft ACPI-Compliant System
392	Microsoft ACPI-Compliant System
393	Microsoft ACPI-Compliant System
394	Microsoft ACPI-Compliant System
395	Microsoft ACPI-Compliant System
396	Microsoft ACPI-Compliant System
397	Microsoft ACPI-Compliant System
398	Microsoft ACPI-Compliant System
399	Microsoft ACPI-Compliant System
400	Microsoft ACPI-Compliant System
401	Microsoft ACPI-Compliant System
402	Microsoft ACPI-Compliant System
403	Microsoft ACPI-Compliant System
404	Microsoft ACPI-Compliant System
405	Microsoft ACPI-Compliant System
406	Microsoft ACPI-Compliant System
407	Microsoft ACPI-Compliant System
408	Microsoft ACPI-Compliant System
409	Microsoft ACPI-Compliant System
410	Microsoft ACPI-Compliant System

IRQ	ASSIGNMENT
411	Microsoft ACPI-Compliant System
412	Microsoft ACPI-Compliant System
413	Microsoft ACPI-Compliant System
414	Microsoft ACPI-Compliant System
415	Microsoft ACPI-Compliant System
416	Microsoft ACPI-Compliant System
417	Microsoft ACPI-Compliant System
418	Microsoft ACPI-Compliant System
419	Microsoft ACPI-Compliant System
420	Microsoft ACPI-Compliant System
421	Microsoft ACPI-Compliant System
422	Microsoft ACPI-Compliant System
423	Microsoft ACPI-Compliant System
424	Microsoft ACPI-Compliant System
425	Microsoft ACPI-Compliant System
426	Microsoft ACPI-Compliant System
427	Microsoft ACPI-Compliant System
428	Microsoft ACPI-Compliant System
429	Microsoft ACPI-Compliant System
430	Microsoft ACPI-Compliant System
431	Microsoft ACPI-Compliant System
432	Microsoft ACPI-Compliant System
433	Microsoft ACPI-Compliant System
434	Microsoft ACPI-Compliant System
435	Microsoft ACPI-Compliant System
436	Microsoft ACPI-Compliant System
437	Microsoft ACPI-Compliant System
438	Microsoft ACPI-Compliant System
439	Microsoft ACPI-Compliant System
440	Microsoft ACPI-Compliant System
441	Microsoft ACPI-Compliant System
442	Microsoft ACPI-Compliant System

IRQ	ASSIGNMENT
443	Microsoft ACPI-Compliant System
444	Microsoft ACPI-Compliant System
445	Microsoft ACPI-Compliant System
446	Microsoft ACPI-Compliant System
447	Microsoft ACPI-Compliant System
448	Microsoft ACPI-Compliant System
449	Microsoft ACPI-Compliant System
450	Microsoft ACPI-Compliant System
451	Microsoft ACPI-Compliant System
452	Microsoft ACPI-Compliant System
453	Microsoft ACPI-Compliant System
454	Microsoft ACPI-Compliant System
455	Microsoft ACPI-Compliant System
456	Microsoft ACPI-Compliant System
457	Microsoft ACPI-Compliant System
458	Microsoft ACPI-Compliant System
459	Microsoft ACPI-Compliant System
460	Microsoft ACPI-Compliant System
461	Microsoft ACPI-Compliant System
462	Microsoft ACPI-Compliant System
463	Microsoft ACPI-Compliant System
464	Microsoft ACPI-Compliant System
465	Microsoft ACPI-Compliant System
466	Microsoft ACPI-Compliant System
467	Microsoft ACPI-Compliant System
468	Microsoft ACPI-Compliant System
469	Microsoft ACPI-Compliant System
470	Microsoft ACPI-Compliant System
471	Microsoft ACPI-Compliant System
472	Microsoft ACPI-Compliant System
473	Microsoft ACPI-Compliant System
474	Microsoft ACPI-Compliant System

IRQ	ASSIGNMENT
475	Microsoft ACPI-Compliant System
476	Microsoft ACPI-Compliant System
477	Microsoft ACPI-Compliant System
478	Microsoft ACPI-Compliant System
479	Microsoft ACPI-Compliant System
480	Microsoft ACPI-Compliant System
481	Microsoft ACPI-Compliant System
482	Microsoft ACPI-Compliant System
483	Microsoft ACPI-Compliant System
484	Microsoft ACPI-Compliant System
485	Microsoft ACPI-Compliant System
486	Microsoft ACPI-Compliant System
487	Microsoft ACPI-Compliant System
488	Microsoft ACPI-Compliant System
489	Microsoft ACPI-Compliant System
490	Microsoft ACPI-Compliant System
491	Microsoft ACPI-Compliant System
492	Microsoft ACPI-Compliant System
493	Microsoft ACPI-Compliant System
494	Microsoft ACPI-Compliant System
495	Microsoft ACPI-Compliant System
496	Microsoft ACPI-Compliant System
497	Microsoft ACPI-Compliant System
498	Microsoft ACPI-Compliant System
499	Microsoft ACPI-Compliant System
500	Microsoft ACPI-Compliant System
501	Microsoft ACPI-Compliant System
502	Microsoft ACPI-Compliant System
503	Microsoft ACPI-Compliant System
504	Microsoft ACPI-Compliant System
505	Microsoft ACPI-Compliant System
506	Microsoft ACPI-Compliant System

IRQ	ASSIGNMENT
507	Microsoft ACPI-Compliant System
508	Microsoft ACPI-Compliant System
509	Microsoft ACPI-Compliant System
510	Microsoft ACPI-Compliant System
511	Microsoft ACPI-Compliant System
4294967291	Intel® HD Graphics
4294967292	Intel® USB 3.0 eXtensible Host Controller - 0100 (Microsoft)
4294967293	Intel® Trusted Execution Engine Interface
4294967294	Realtek PCIe GBE Family Controller

3-7-2. DMA Channels Map

TIMER CHANNEL	ASSIGNMENT
Channel 4	Direct memory access controller

3-7-3. I/O Map

I/O MAP	ASSIGNMENT
0x00000000-0x0000006F	PCI Express Root Complex
0x00000020-0x00000021	Programmable interrupt controller
0x00000024-0x00000025	Programmable interrupt controller
0x00000028-0x00000029	Programmable interrupt controller
0x0000002C-0x0000002D	Programmable interrupt controller
0x0000002E-0x0000002F	Motherboard resources
0x00000030-0x00000031	Programmable interrupt controller
0x00000034-0x00000035	Programmable interrupt controller
0x00000038-0x00000039	Programmable interrupt controller
0x0000003C-0x0000003D	Programmable interrupt controller
0x00000040-0x00000043	System timer
0x0000004E-0x0000004F	Motherboard resources
0x00000050-0x00000053	System timer
0x00000060-0x00000060	Standard PS/2 Keyboard
0x00000061-0x00000061	Motherboard resources
0x00000063-0x00000063	Motherboard resources
0x00000064-0x00000064	Standard PS/2 Keyboard
0x00000065-0x00000065	Motherboard resources
0x00000067-0x00000067	Motherboard resources
0x00000070-0x00000070	Motherboard resources
0x00000070-0x00000070	System CMOS/real time clock
0x00000078-0x000000CF7	PCI Express Root Complex
0x00000080-0x0000008F	Motherboard resources
0x00000092-0x00000092	Motherboard resources
0x000000A0-0x000000A1	Programmable interrupt controller
0x000000A4-0x000000A5	Programmable interrupt controller
0x000000A8-0x000000A9	Programmable interrupt controller
0x000000AC-0x000000AD	Programmable interrupt controller
0x000000B0-0x000000B1	Programmable interrupt controller
0x000000B2-0x000000B3	Motherboard resources

I/O MAP	ASSIGNMENT
0x000000B4-0x000000B5	Programmable interrupt controller
0x000000B8-0x000000B9	Programmable interrupt controller
0x000000BC-0x000000BD	Programmable interrupt controller
0x000002E8-0x000002EF	Communications Port (COM4)
0x000002F8-0x000002FF	Communications Port (COM2)
0x00000378-0x0000037F	Printer Port (LPT1)
0x000003B0-0x000003BB	Intel® HD Graphics
0x000003C0-0x000003DF	Intel® HD Graphics
0x000003E8-0x000003EF	Communications Port (COM3)
0x000003F8-0x000003FF	Communications Port (COM1)
0x00000400-0x0000047F	Motherboard resources
0x000004D0-0x000004D1	Programmable interrupt controller
0x00000500-0x000005FE	Motherboard resources
0x00000600-0x0000061F	Motherboard resources
0x00000680-0x0000069F	Motherboard resources
0x00000A00-0x00000A0F	Motherboard resources
0x00000A10-0x00000A1F	Motherboard resources
0x00000A20-0x00000A2F	Motherboard resources
0x00000D00-0x0000FFFF	PCI Express Root Complex
0x0000164E-0x0000164F	Motherboard resources
0x0000E000-0x0000E0FF	Realtek PCIe GBE Family Controller
0x0000E000-0x0000E0FF	Intel® Pentium® processor N- and J-series / Intel® Celeron® processor N- and J-series PCI Express - Root Port 4 - 0F4E
0x0000F000-0x0000F01F	Intel® Pentium® processor N- and J-series / Intel® Celeron® processor N- and J-series Platform Control Unit - SMBus Port - 0F12
0x0000F020-0x0000F03F	Intel® Pentium® processor N- and J-series / Intel® Celeron® processor N- and J-series AHCI - 0F23
0x0000F040-0x0000F043	Intel® Pentium® processor N- and J-series / Intel® Celeron® processor N- and J-series AHCI - 0F23
0x0000F050-0x0000F057	Intel® Pentium® processor N- and J-series / Intel® Celeron® processor N- and J-series AHCI - 0F23

I/O MAP	ASSIGNMENT
0x0000F060-0x0000F063	Intel® Pentium® processor N- and J-series / Intel® Celeron® processor N- and J-series AHCI - 0F23
0x0000F070-0x0000F077	Intel® Pentium® processor N- and J-series / Intel® Celeron® processor N- and J-series AHCI - 0F23
0x0000F080-0x0000F087	Intel® HD Graphics

3-7-4. Memory Map

MEMORY MAP	ASSIGNMENT
0xE0000000-0xFFFFFFFF	Motherboard resources
0xFED01000-0xFED01FFF	Motherboard resources
0xFED03000-0xFED03FFF	Motherboard resources
0xFED04000-0xFED04FFF	Motherboard resources
0xFED0C000-0xFED0FFFF	Motherboard resources
0xFED08000-0xFED08FFF	Motherboard resources
0xFED1C000-0xFED1CFFF	Motherboard resources
0xFEE00000-0xFEEFFFFF	Motherboard resources
0xFE000000-0xFEFFFFFF	Motherboard resources
0xD0604000-0xD0604FFF	Realtek PCIe GBE Family Controller
0xD0600000-0xD0603FFF	Realtek PCIe GBE Family Controller
0xD0600000-0xD0603FFF	Intel® Pentium® processor N- and J-series / Intel® Celeron® processor N- and J-series PCI Express - Root Port 4 - 0F4E
0xFED00000-0xFED003FF	High precision event timer
0xC0000000-0xD0711FFE	PCI Express Root Complex
0xC0000000-0xD0711FFE	Intel® HD Graphics
0xD0000000-0xD03FFFFFFF	Intel® HD Graphics
0xD0700000-0xD070FFFF	Intel® USB 3.0 eXtensible Host Controller - 0100 (Microsoft)
0xD0710000-0xD071001F	Intel® Pentium® processor N- and J-series / Intel® Celeron® processor N- and J-series Platform Control Unit - SMBus Port - 0F12
0xD0500000-0xD05FFFFFFF	Intel® Trusted Execution Engine Interface
0xD0400000-0xD04FFFFFFF	Intel® Trusted Execution Engine Interface
0xD0711000-0xD07117FF	Intel® Pentium® processor N- and J-series / Intel® Celeron® processor N- and J-series AHCI - 0F23

MEMORY MAP	ASSIGNMENT
0xE00000D0-0xE00000DB	Intel [®] Sideband Fabric Device
0xFF000000-0xFFFFFFFF	Intel [®] 82802 Firmware Hub Device
0xA0000-0xBFFFF	PCI Express Root Complex
0xA0000-0xBFFFF	Intel [®] HD Graphics
0xC0000-0xDFFFF	PCI Express Root Complex
0xE0000-0xFFFFF	PCI Express Root Complex

SYSTEM DIAGRAMS

CHAPTER 4

This chapter contains exploded diagrams and part numbers of the PA-3122 system.

The following sections are included:

- Exploded Diagram for System Top Case
- Exploded Diagram for System LCD Panel
- Exploded Diagram for System Bottom Case
- Exploded Diagram for MSR
- Exploded Diagram for VFD
- Exploded Diagram for Printer
- Exploded Diagram for HDD

EXPLODED DIAGRAM FOR SYSTEM TOP CASE

Open the System Top Module

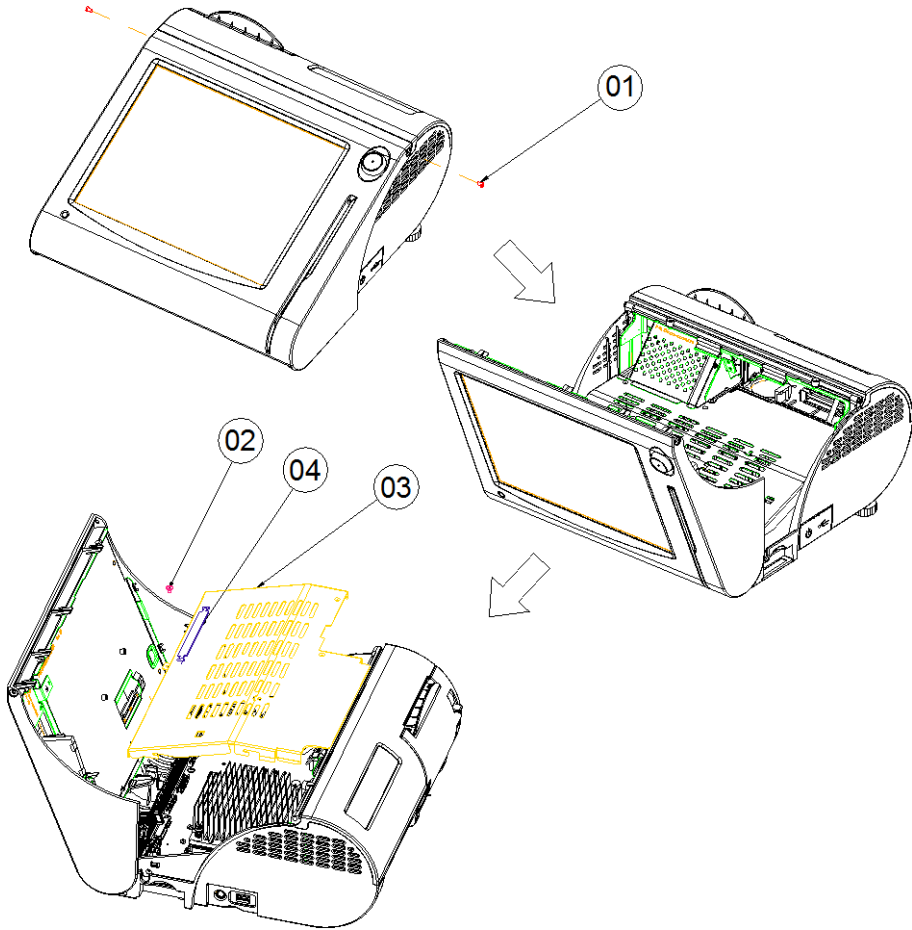

No.	Name	P/N No.	Qt'y
1	M3_L4_I_B	22-272-30004318	2
2	M3_L5_Washer_Ni	22-242-30005311	1
3	3520 Inside_top	20-040-03002210	1
4	PULLER	30-080-04100000	1

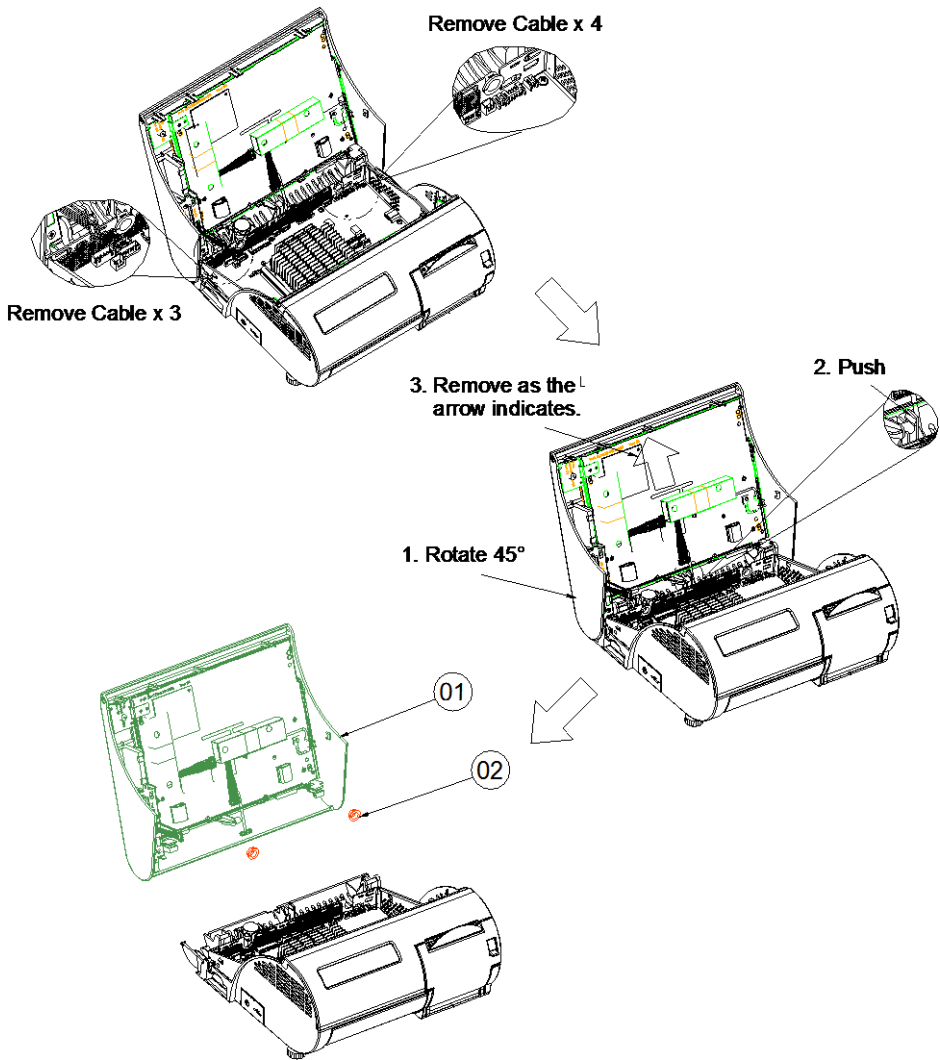

No.	Name	P/N No.	Qty
1	TOP Assembly	--	1
2	Open Closed Bushing	30-026-04300000	2

With i-Button

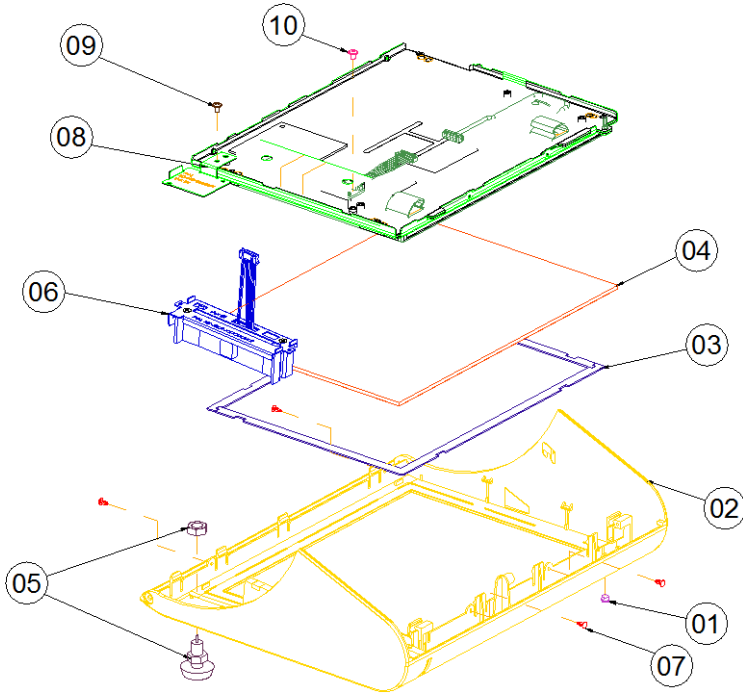

No.	Name	P/N No.	Qty
1	LED CAP	30-012-02100000	1
2	I-BOUNT TOP CASE(Blue)	30-003-28310165	1
	I-BOUNT TOP CASE(Red)	30-003-28610165	
	I-BOUNT TOP CASE(White)	30-003-28112165	
	I-BOUNT TOP CASE(Black)	30-003-28113165	
3	Touch_EVA	30-013-15100166	2
4	ELO 10.4" Touch	52-380-01510401	1
5	I Button	52-551-00100002	1
6	MSR Assembly	--	1
7	Plastic rivet	90-042-04100000	4
8	LCD Assembly	--	1
9	M3_L5_Washer_Ni (I-Button GND screw)	22-242-30005311	1
10	M3_L5_Washer_Ni (MSR GND screw)	22-242-30005311	1

With Fingerprinter

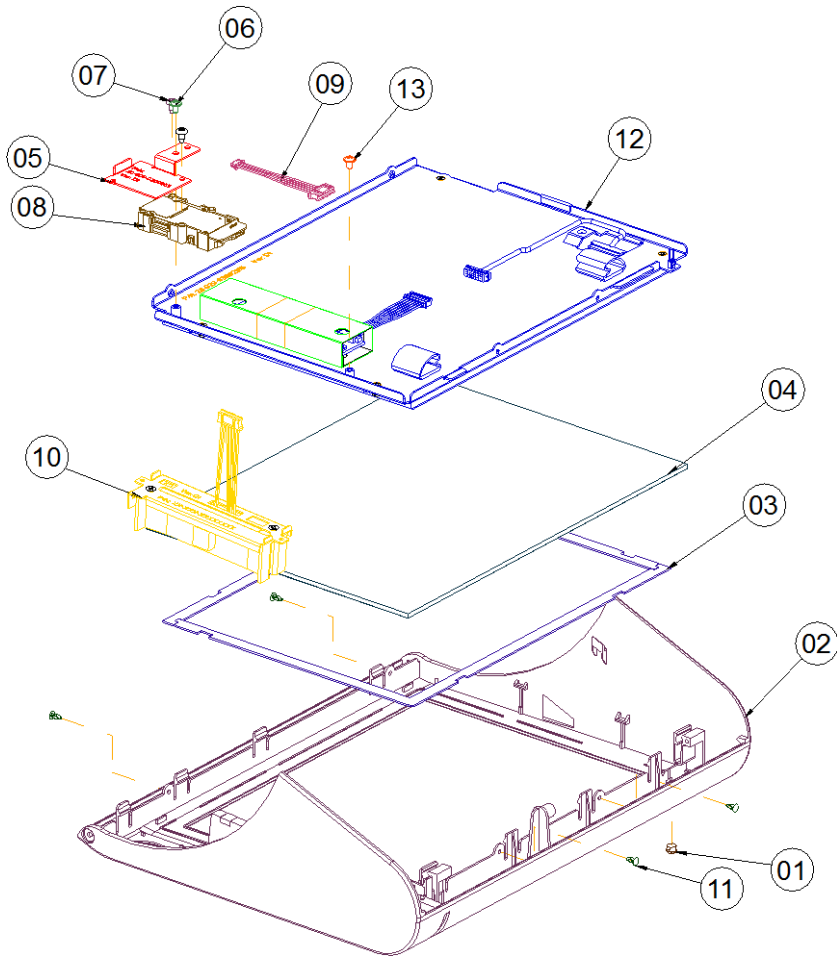

No.	Name	P/N No.	Qty
1	LED CAP	30-012-02100000	1
2	FINGER-PRINTER TOP CASE(Blue)	30-003-28210165	1
	FINGER-PRINTER TOP CASE((Red)	30-003-28510165	
	FINGER-PRINTER TOP CASE((White)	30-003-28910165	
	FINGER-PRINTER TOP CASE((Black)	30-003-28111165	
3	Touch_EVA	30-013-15100166	2
4	ELO 10.4" Touch	52-380-01510401	1
5	Finger-printer holder	20-006-03001165	1
6	M3_L5_Washer_Ni	22-242-30005311	1
7	T3_L8_R_Ni	22-122-30080011	1
8	Finger-Printr	52-551-00501205	1
9	Finger-Printr cable	27-006-16506111	1
10	MSR Assembly	--	1
11	Plastic rivet	90-042-04100000	4
12	LCD Assembly	--	1
13	M3_L5_Washer_Ni (MSR GND screw)	22-242-30005311	1

With MSR

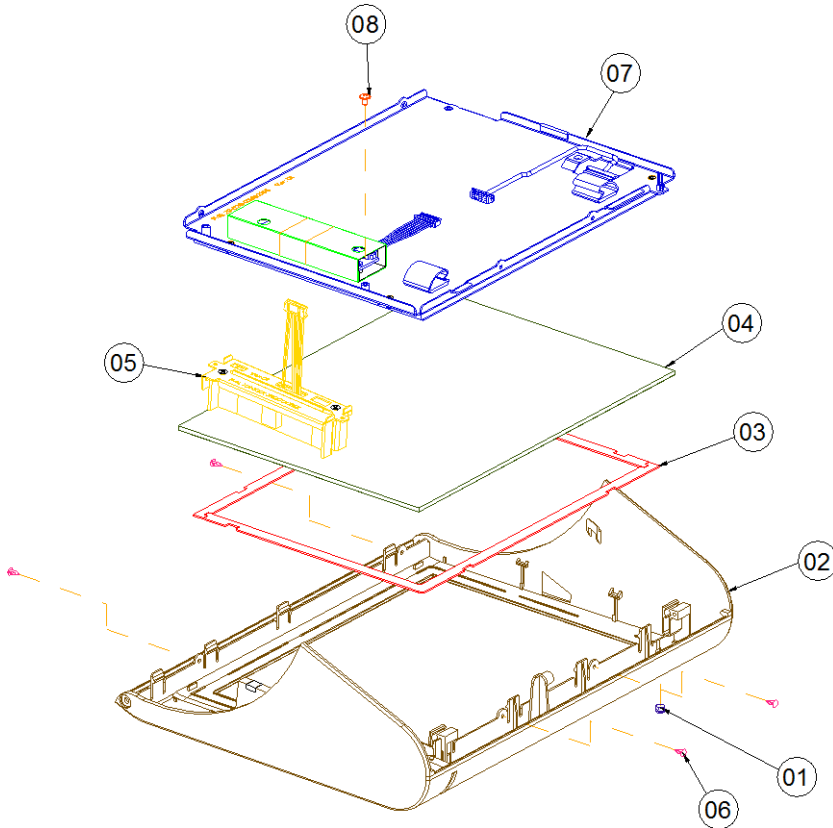

No.	Name	P/N No.	Qty
1	LED CAP	30-012-02100000	1
2	Empty TOP CASSE(Blue)	30-003-28110165	1
	Empty TOP CASSE(Red)	30-003-28410165	
	Empty TOP CASSE(White)	30-003-28710165	
	FINGER-PRINTER TOP CASE(Black)	30-003-28810165	
3	Touch_EVA	30-013-15100166	2
4	ELO 10,4" Touch	52-380-01510401	1
5	MSR Assembly	--	1
6	Plastic rivet	90-042-04100000	4
7	LCD Assembly	--	1
8	M3-L5 Washer-Ni (MSR GND screw)	22-242-30005311	1

With MSR

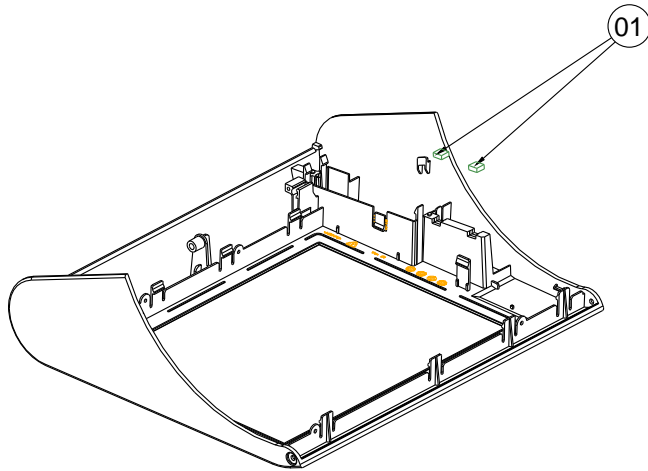

Without MSR

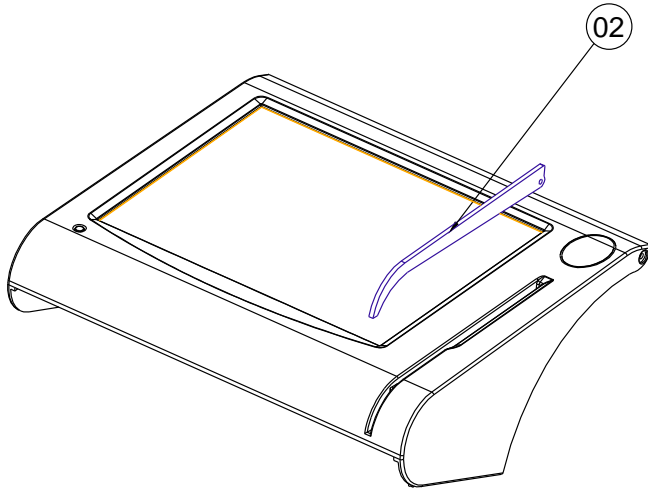

No.	Name	P/N No.	Qty
1	EVA BLOCK	30-013-15100165	2
2	MSR EVA	30-013-15200165	1

EXPLODED DIAGRAM FOR SYSTEM LCD PANEL

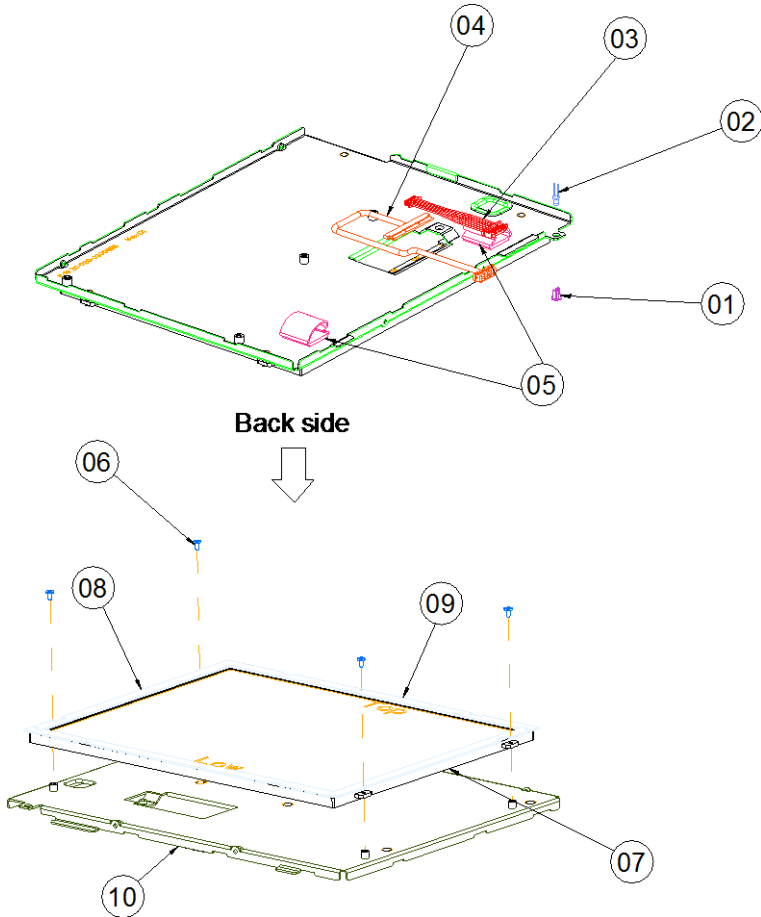

NO.	Component Name	Part No.	Qty
1	LED HOUSING	30-014-04100165	1
2	LED CABLE	27-018-16503071	1
3	INVERTER CABLE	27-015-16506111	1
4	CPT LVDS CABLE	27-020-16505111	1
5	CABLE CLAMP	30-023-04300010	2
6	SCREW	22-272-20004011	4
7	CPT 10.4" LCD	52-351-01104019	1
8	167 X 4 X 0.5T PORON	30-013-24700000	2
9	220 X 4 X 0.5T PORON	30-013-24600000	2
10	CPT LCD HOLDER	20-029-03001165	1

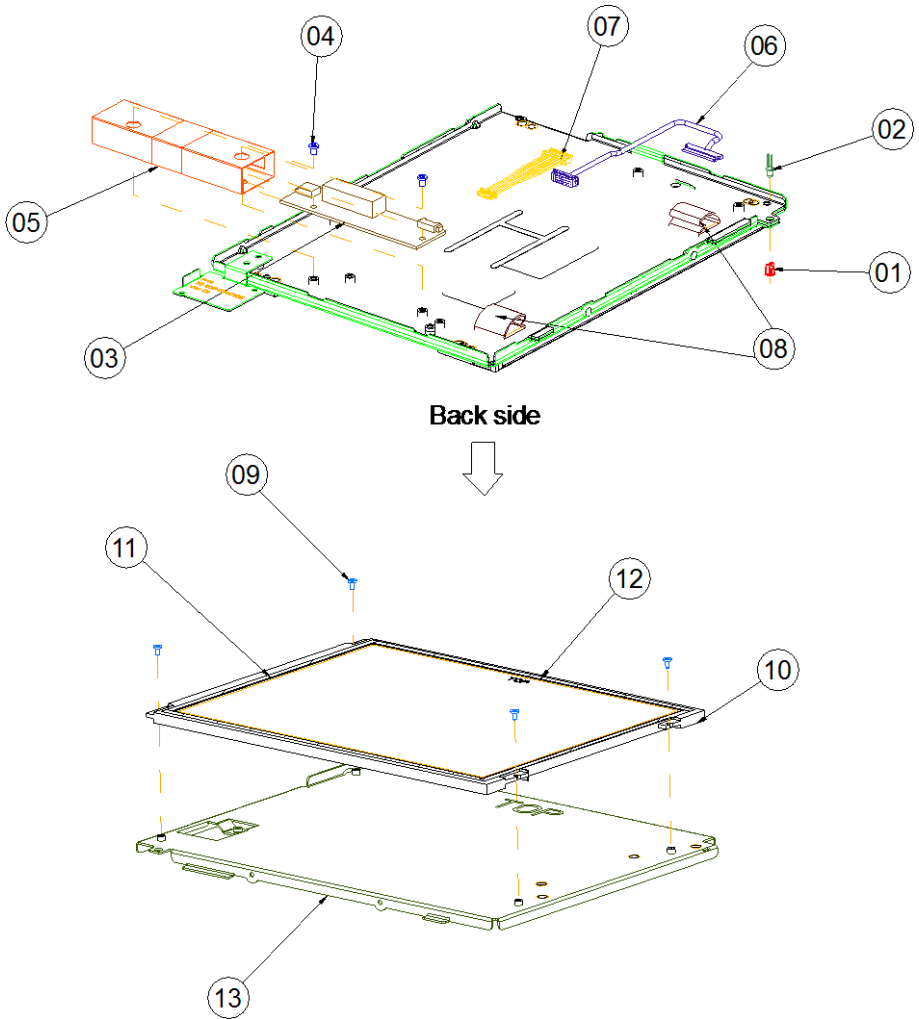

Back side



No.	Name	P/N No.	Qty
1	LED Housing	30-014-04100165	1
2	Led Cable	27-018-16503071	1
3	Inverter	52-101-08010003	1
4	M3_L4_I_B	22-272-30004318	2
5	Inverter Mylar	30-056-02100165	1
6	LVDS cable	27-020-16505112	1
7	inverter cable	27-015-16506111	1
8	cable_clamp	30-023-04300010	2
9	M2_L4_I_Ni	22-272-20004011	4
10	TIANMA 10.4" LCD PANEL	52-351-01104228	1
11	167 X 4 X0.5T PORON	30-013-24700000	2
12	220 X 4 X0.5T PORON	30-013-24600000	2
13	LCD Holder	20-029-03002165	1

EXPLODED DIAGRAM FOR SYSTEM BOTTOM CASE

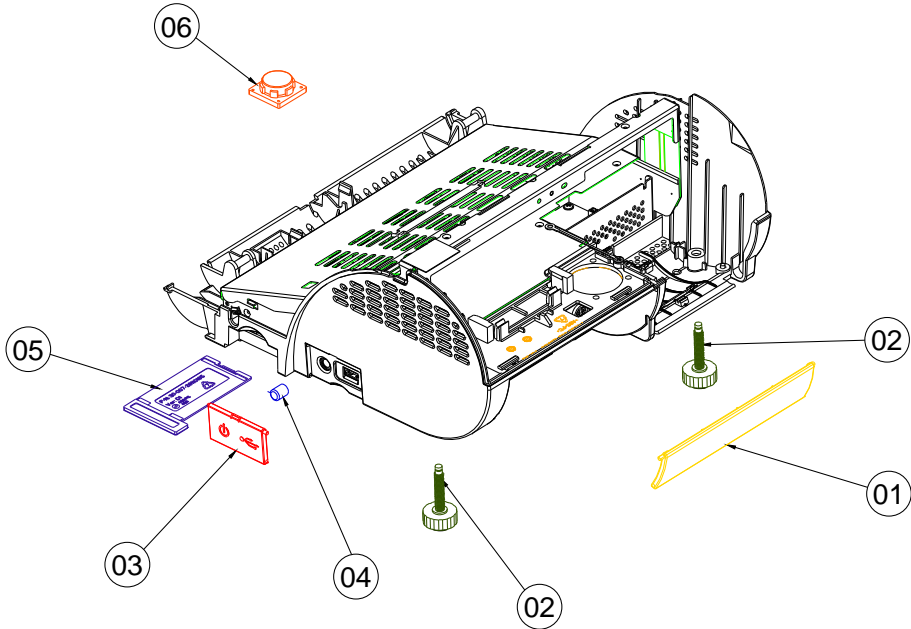

No.	Name	P/N No.	Qty
1	IO Cover(white)	30-002-28810165	1
	IO Cover(black)	30-002-28110165	
2	Foot	22-289-60035007	2
3	side Door(white)	30-007-28410165	1
	side Door(black)	30-007-28120165	
4	Switch cap	30-001-28100099	1
5	MINI_Pcie_Door(white)	30-007-28310165	1
	MINI_Pcie_Door(black)	30-007-28110165	
6	Speaker	13-500-08280018	1

Printer Control Board

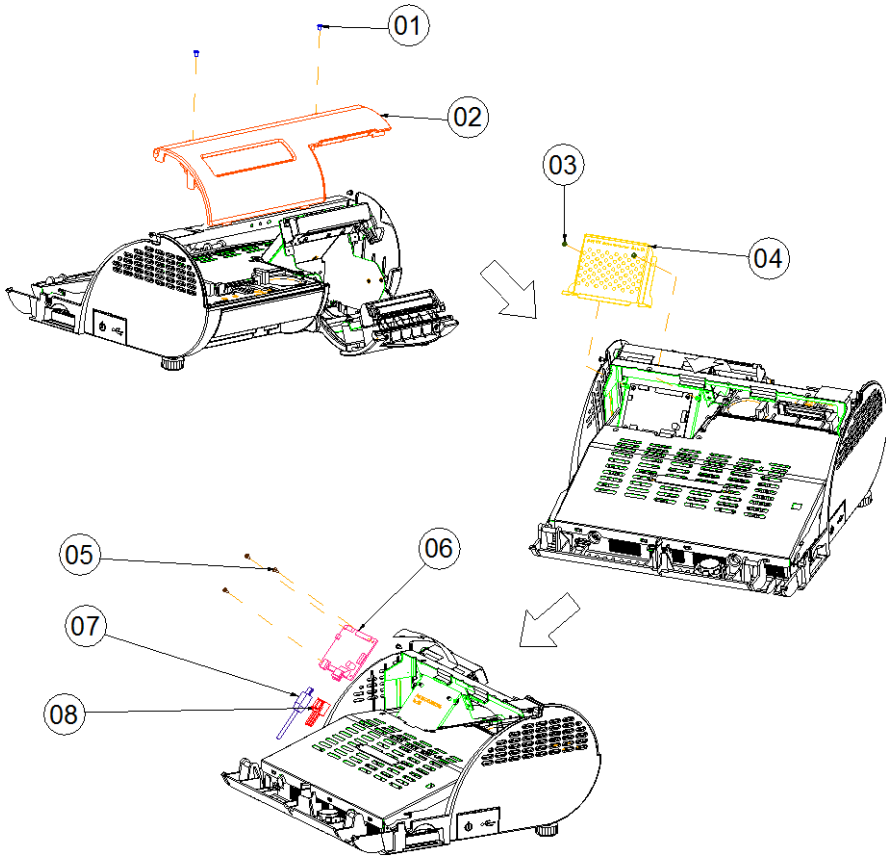

No.	Name	P/N No.	Qt'y
1	M3_L4_L_B	22-272-30004318	2
2	VFD Assembly	SEE PAGE 15, 16	1
3	M2.5_L4_R_Ni	22-232-25004011	2
4	PCB_COVER	20-004-03001165	1
5	M2_L4_W_Ni	22-232-20004311	3
6	Printer PCB	MB-1030RA-11N	1
7	Printer USB cable	See order	1
8	Printer Power Cable	See order	1

Printer Box

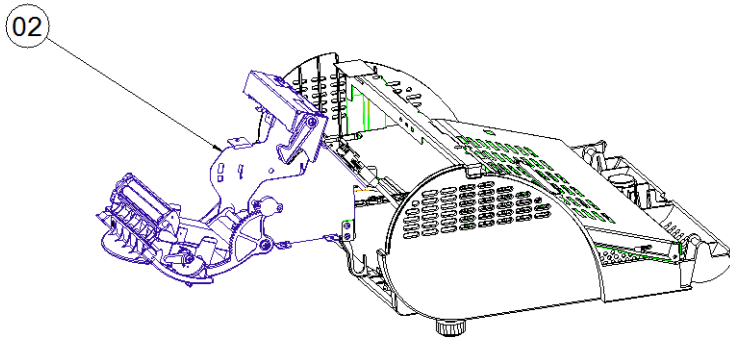
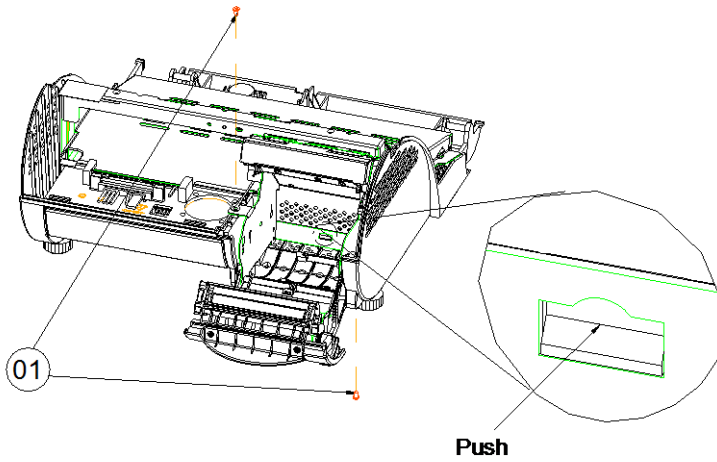

No.	Name	P/N No.	Qty
1	M3_L4_I_B	22-272-30004318	2
2	Printer Assembly	--	1

Heatsink

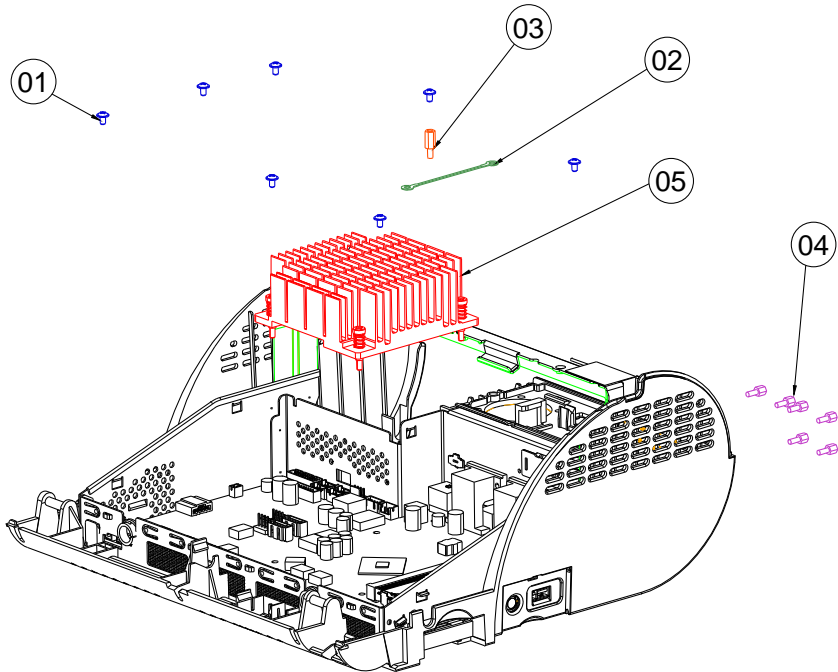

No.	Name	P/N No.	Qt'y
1	M3_L5_Washer_Ni	22-242-30005311	10
2	PrInter ground cable	27-030-16504071	1
3	M3_H10_BOSS	22-290-30010001	1
4	No.4 Boss	22-692-40048051	6
5	HEATSINK	--	1

Mainboard

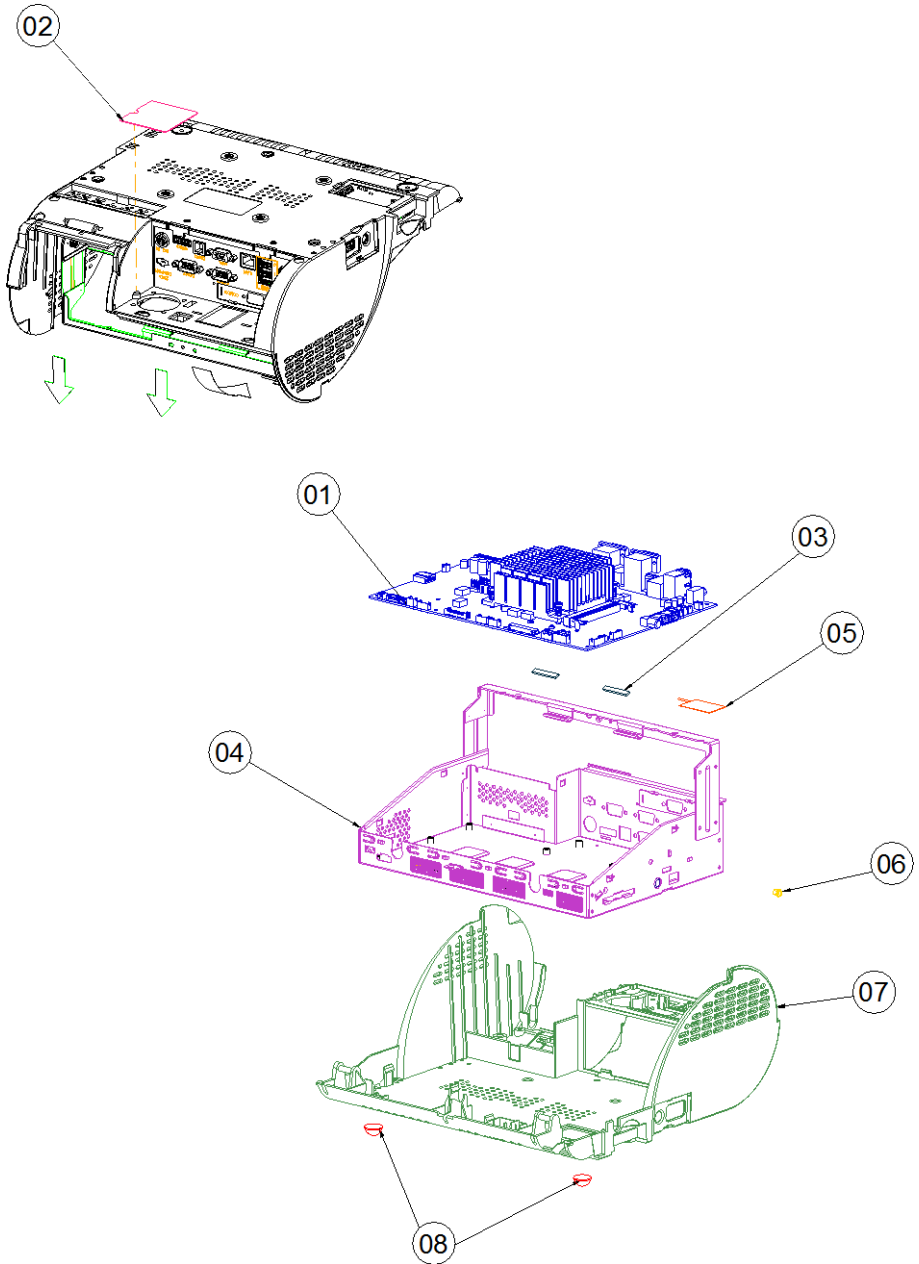

No.	Name	P/N No.	Qty
1	PB-6822	PB-6822	1
2	PC Sheet	90-056-02100254	3
3	EMI SPONGE	30-050-31200000	2
4	3122 inside box	20-040-03001310	1
5	WIRELESS_ANTENNA	27-029-16506071	1
6	SB-0305	30-026-04100008	1
7	PS3100 BOT CASE(White)	30-002-12110210	1
	PS3100 BOT CASE(Black)	30-002-12210210	
8	Rubber Foot	30-004-01500000	1

EXPLODED DIAGRAM FOR PRINTER

3 Inch Printer

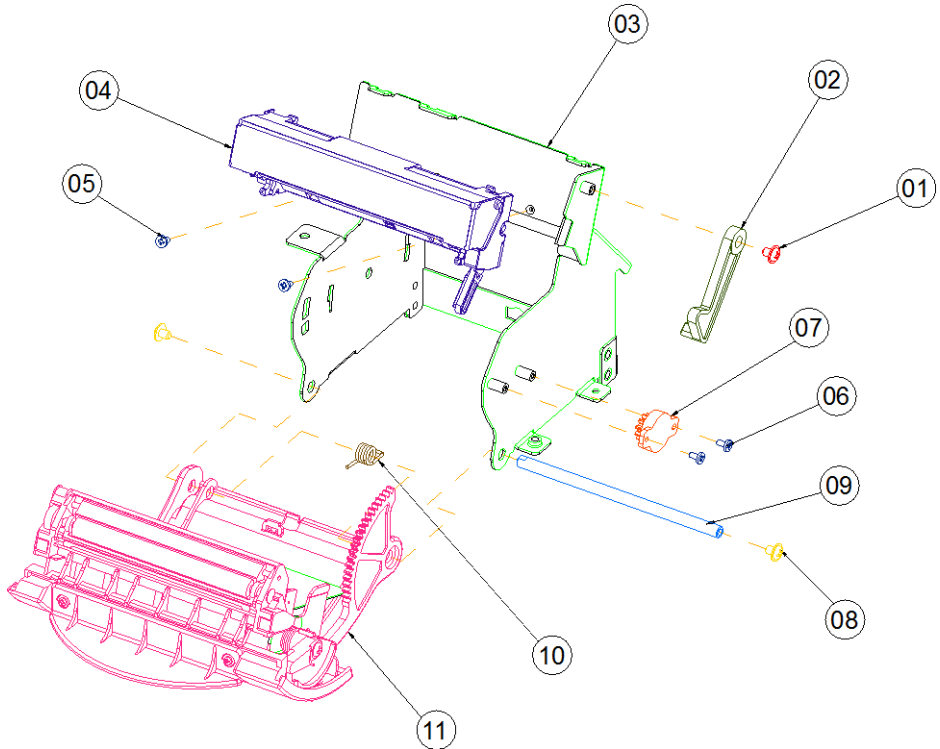

No.	Name	P/N No.	Qty
1	M3_I_L4_Black	22-272-30004318	1
2	Printer_add_arm(White)	30-002-09410165	1
	Printer_add_arm(black)	30-002-09110165	
3	PS3100-PRINTER-BOX-V2	22-272-30004318	1
4	CAPD34X_A_01 (3")	52-701-00017003	1/2
5	M2_I_L4_Ni	22-272-20004011	2
6	M2_I_L4_Ni	22-272-20004011	2
7	ROTARY DAMPER	30-022-09110000	1
8	M3_Washer_L5_Ni	22-242-30005311	2
9	Paper_cover_pin	20-004-10011165	1
10	PS3100-SPRING-1	23-002-00000701	1
11	Paper_cover_Assembly	--	1

3 Inch Printer Cover

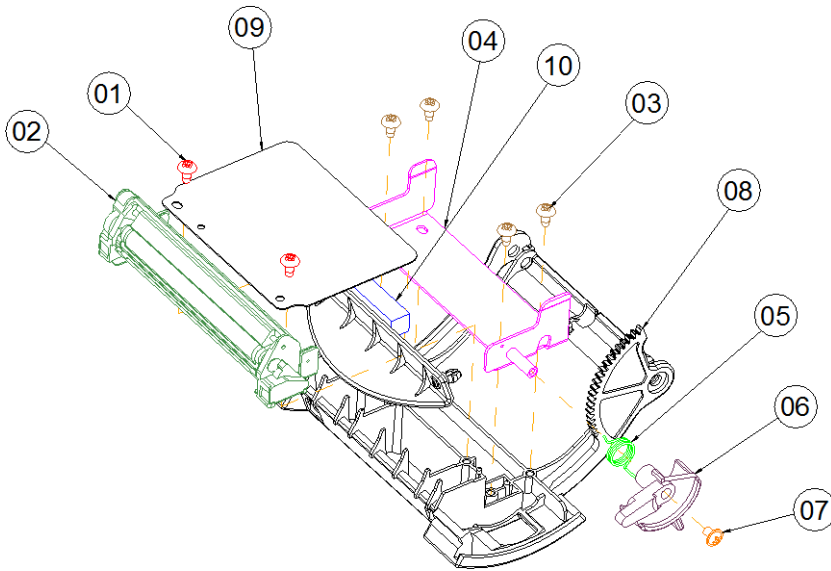

No.	Name	P/N No.	Qty
1	T3_R_L8_Black	22-122-30080011	2
2	CAPD34X_A_01 (3")	52-701-00017003	1/2
3	T3_R_L6_Ni	22-132-30060011	4
4	PS-3100 INCLUDE HOLDER	20-029-03006165	1
5	PS3100-SPRING-FOR-EJECTOR	23-002-00001021	1
6	PRINTER_COVER_EJECTOR(White)	30-002-09310165	1
	PRINTER_COVER_EJECTOR(Black)	30-002-09210165	
7	M3_I_L4_Black	22-272-30004318	1
8	PS3100_PAPER_COVER_V2(White)	30-002-02630165	1
	PS3100_PAPER_COVER_V2(Black)	30-002-02530165	

2 Inch Printer

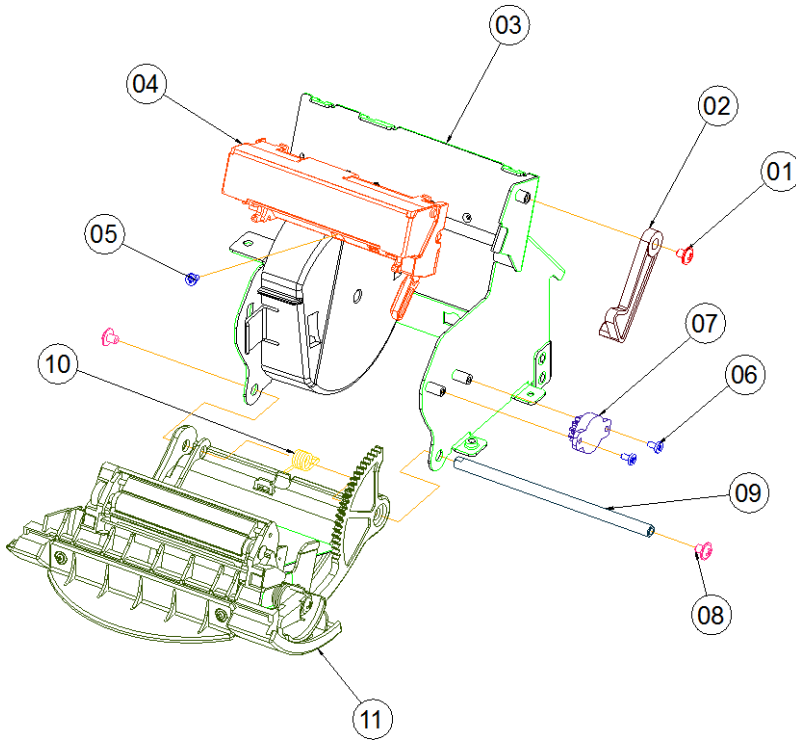

No.	Name	P/N No.	Qt'y
1	M3_I_L4_Black	22-272-30004318	1
2	Printer_add_arm(white)	30-002-09410165	1
	Printer_add_arm(black)	30-002-09110165	
3	PS3100_PRINTER_BOX_V2	20-040-03004165	1
4	CAPD24X_A_03 (2")	52-701-00020003	1/2
5	M2_I_L4_Ni	22-272-20004011	1
6	M2_I_L4_Ni	22-272-20004011	2
7	ROTARY DAMPER	30-022-09110000	1
8	M3_Washer_L5_Ni	22-242-30005311	2
9	Paper_cover_pin	20-004-10011165	1
10	PS3100-SPRING-1	23-002-00000701	1
11	Paper_cover_Assembly	--	1
12	ADD_PAPER_WALL	30-002-28310165	1

2 Inch Printer Cover

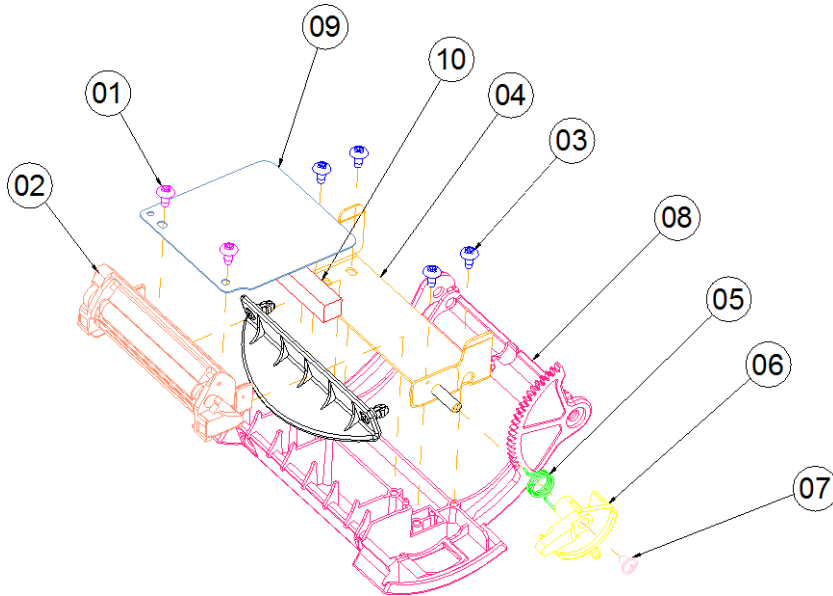

No.	Name	P/N No.	Qty
1	T3_R_L8_Black	22-122-30080011	2
2	CAPD24X_A_03 (2")	52-701-00020003	1/2
3	T3_R_L6_Ni	22-132-30060011	4
4	PS-3100 INCLUDE HOLDER	20-029-03006165	1
5	PS3100-SPRING-FOR_EJECTOR	23-002-00001021	1
6	PRINTER_COVER_EJECTOR(White)	30-002-09310165	1
	PRINTER_COVER_EJECTOR(Black)	30-002-09210165	
7	M3_I_L4_Black	22-272-30004318	1
8	PS3100_PAPER_COVER_V2(White)	30-002-02630165	1
	PS3100_PAPER_COVER_V2(Black)	30-002-02530165	
9	2INCH_ADD_MYLAR2	90-056-02300165	1
10	2inch_add_EVA	90-013-15200165	1

With Paper Holder

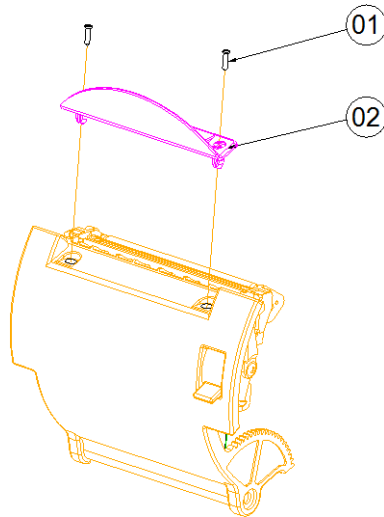

Without Paper Holder

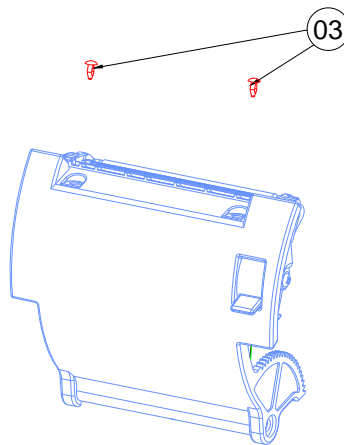

No.	Name	P/N No.	Qty
1	T2_L8_Black	22-125-20008011	2
2	PAPER HOLDER(Transparent)	30-012-02210165	1
	PAPER HOLDER(Black)	30-012-02110165	
3	∅4 Plastic rivet	90-076-04110000	2

EXPLODED DIAGRAM FOR MSR

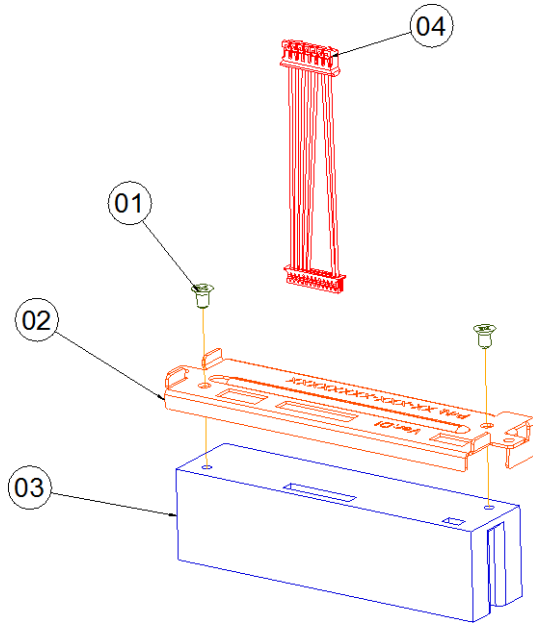

No.	Name	P/N No.	Qt'y
1	M6_L6_F_B	22-215-30060011	2
2	MSR HOLDER	20-029-03004165	1
3	MSR MODULE	MB-3013RA-11N	1
4	MSR CABLE	27-014-27004111	1

EXPLODED DIAGRAM FOR VFD

VFD Module

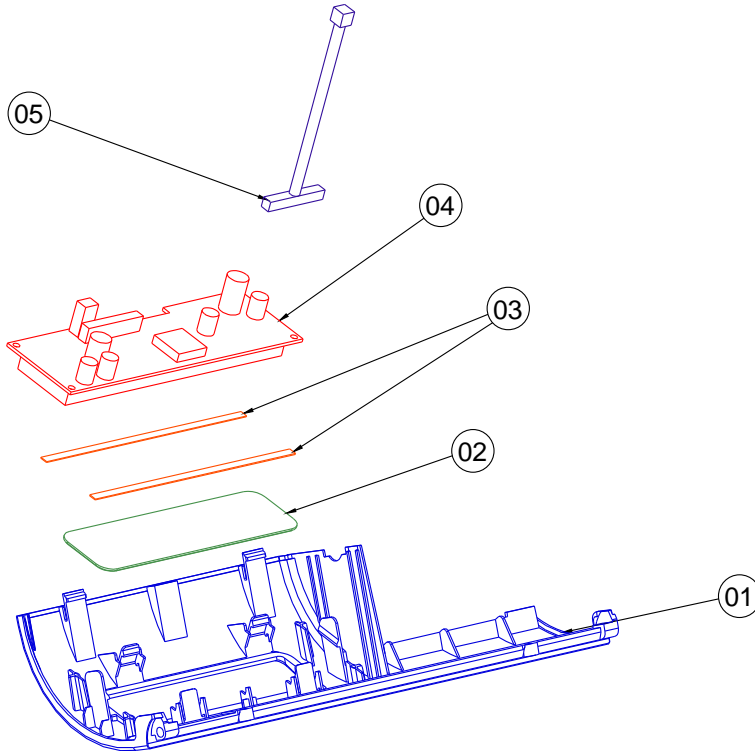

No.	Name	P/N No.	Qty
1	VFD_COVER(White)	30-002-28113165	1
	VFD_COVER(Black)	30-002-28114165	
	VFD_COVER(Blue)	30-002-28410165	
	VFD_COVER(Red)	30-002-28610165	
2	VFD_WINDOWS	30-002-02230165	1
3	PORON	90-013-24100165	2
4	VFD_MODULE	MB-4103RA-11N	1
5	VFD_CABLE	27-051-26805111	1

Without VFD Module

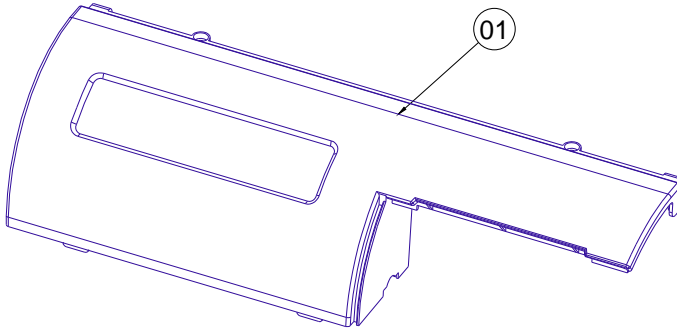

No.	Name	P/N No.	Qty
1	WITHOUT VFD_COVER(White)	30-002-28111165	1
	WITHOUT VFD_COVER(Black)	30-002-28112165	
	WITHOUT VFD_COVER(Blue)	30-002-28510165	
	WITHOUT VFD_COVER(Red)	30-002-28710165	

EXPLODED DIAGRAM FOR HDD

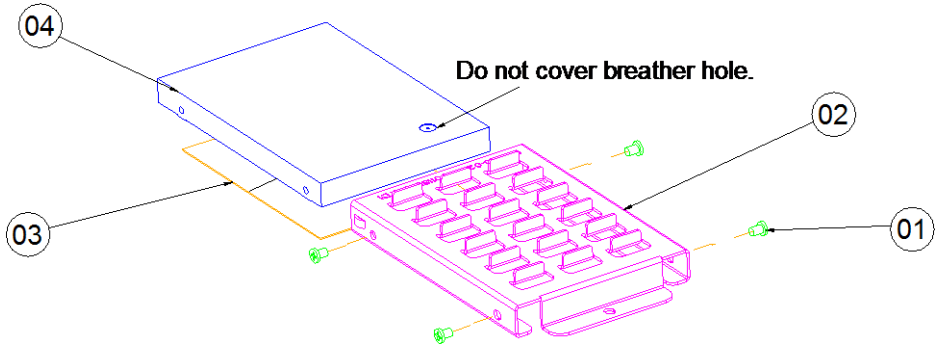

No.	Name	P/N No.	Qty
1	M3_L4_I_B	22-272-30004318	4
2	HDD_holder	20-029-01001165	1
3	Thermal Pad	21-006-84535001	2
4	HDD	SEE ORDER	1